

SKKT 323/18 E



SEMIPACK® 3

Thyristor Modules

SKKT 323/18 E

Features*

- Industrial standard package
- Electrically insulated base plate
- Heat transfer through aluminum oxide ceramic insulated metal base plate
- Chip soldered on direct copper bonded Al₂O₃ ceramic
- UL recognition, file no. E63532

Typical Applications

- DC motor control (e. g. for machine tools)
- Temperature control (e. g. for ovens, chemical processes)
- Professional light dimming (studios, theaters)

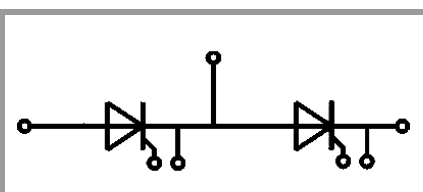

SKKT

Absolute Maximum Ratings				
Symbol	Conditions		Values	Unit
Chip				
I _{T(AV)}	sinus 180°	T _c = 85 °C	320	A
		T _c = 100 °C	241	A
I _{TSM}	10 ms	T _j = 25 °C	9500	A
		T _j = 130 °C	8200	A
i ² t	10 ms	T _j = 25 °C	451250	A ² s
		T _j = 130 °C	336200	A ² s
V _{RSM}			1900	V
V _{RRM}			1800	V
V _{DRM}			1800	V
(di/dt) _{cr}	T _j = 130 °C		130	A/μs
(dv/dt) _{cr}	T _j = 130 °C		1000	V/μs
T _j			-40 ... 130	°C
Module				
T _{stg}			-40 ... 125	°C
V _{isol}	a.c.; 50 Hz; r.m.s.	1 min	3000	V
		1 s	3600	V

Characteristics						
Symbol	Conditions		min.	typ.	max.	Unit
Chip						
V _T	T _j = 25 °C, I _T = 750 A				1.45	V
V _{T(TO)}	T _j = 130 °C				0.81	V
r _T	T _j = 130 °C				0.85	mΩ
I _{DD} ; I _{RD}	T _j = 130 °C, V _{DD} = V _{DRM} ; V _{RD} = V _{RRM}				100	mA
t _{gd}	T _j = 25 °C, I _G = 1 A, di _G /dt = 1 A/μs			1		μs
t _{gr}	V _D = 0.67 * V _{DRM}			2		μs
t _q	T _j = 130 °C			150		μs
I _H	T _j = 25 °C			150	500	mA
I _L	T _j = 25 °C, R _G = 33 Ω			300	2000	mA
V _{GT}	T _j = 25 °C, d.c.		2			V
I _{GT}	T _j = 25 °C, d.c.		150			mA
V _{GD}	T _j = 130 °C, d.c.				0.25	V
I _{GD}	T _j = 130 °C, d.c.				10	mA
R _{th(j-c)}	cont.	per chip			0.091	K/W
		per module			0.0455	K/W
R _{th(j-c)}	sin. 180°	per chip			0.095	K/W
		per module			0.048	K/W
R _{th(j-c)}	rec. 120°	per chip			0.11	K/W
		per module			0.055	K/W
Module						
R _{th(c-s)}	chip			0.08		K/W
	module			0.04		K/W
M _s	to heatsink M5		4.25		5.75	Nm
M _t	to terminals M8		7.65		10.35	Nm
a					5 * 9.81	m/s ²
w				410		g

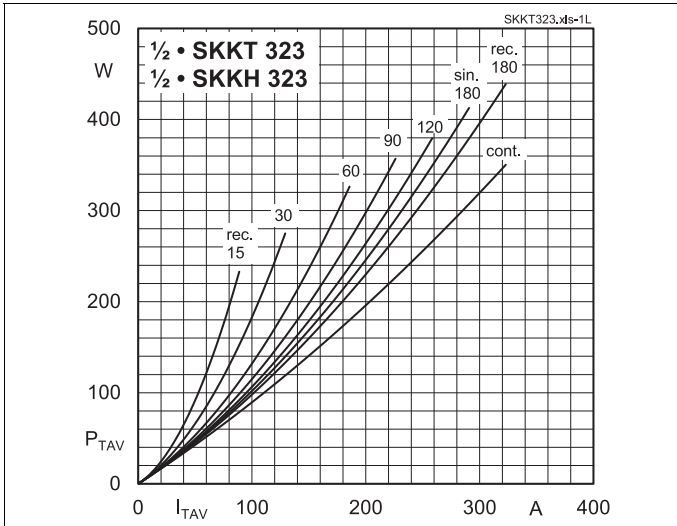

Fig. 1L: Power dissipation per thyristor/diode vs. on-state current

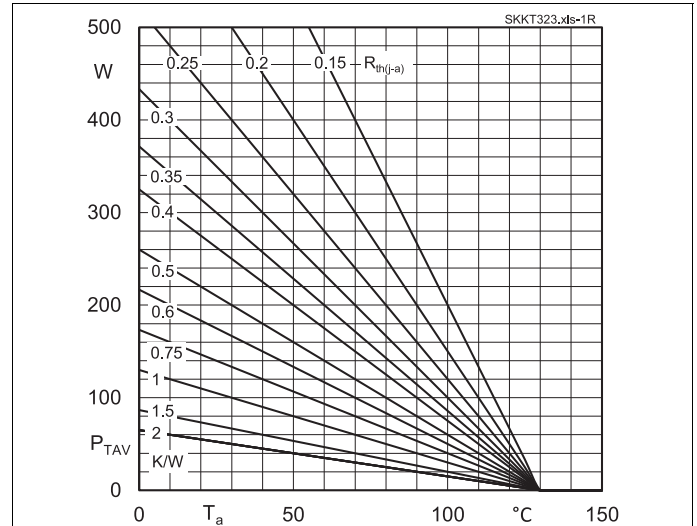

Fig. 1R: Power dissipation per thyristor/diode vs. ambient temperature

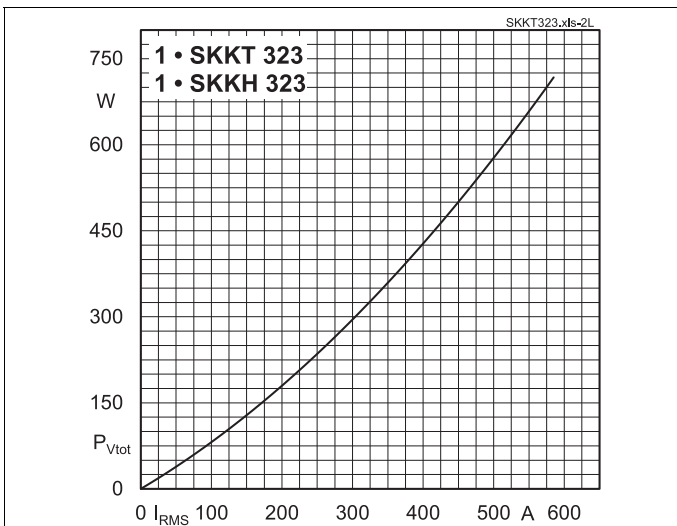

Fig. 2L: Power dissipation of one module vs. rms current

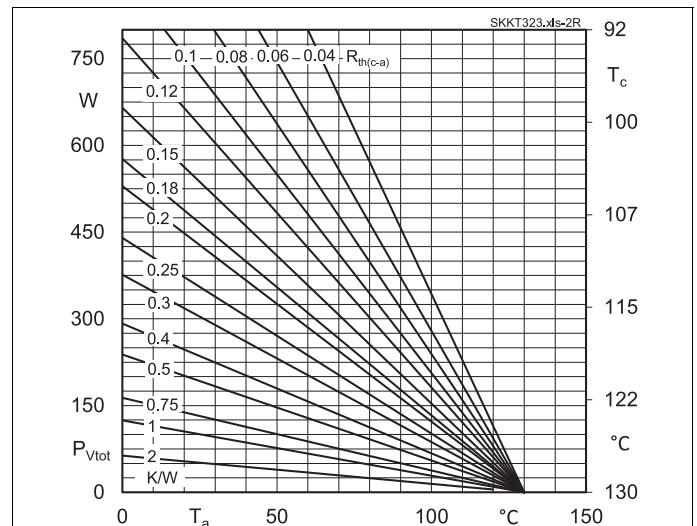

Fig. 2R: Power dissipation of one module vs. case temperature

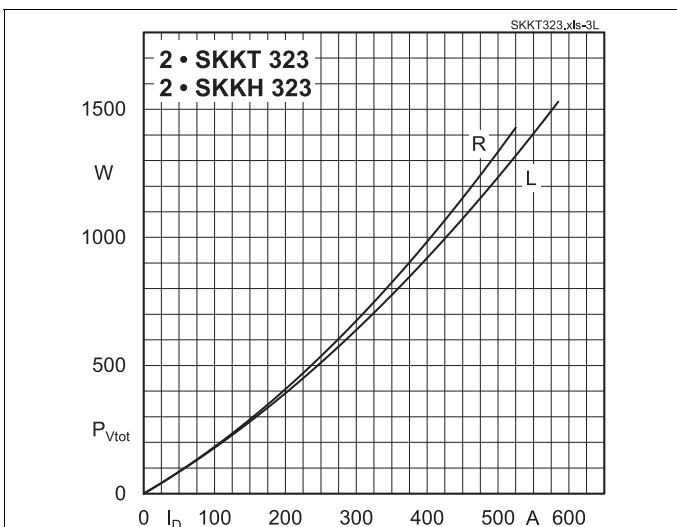

Fig. 3L: Power dissipation of two modules vs. direct current

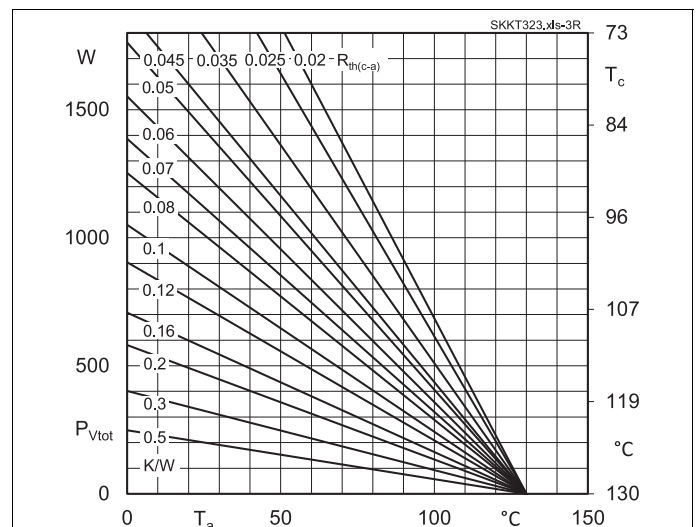

Fig. 3R: Power dissipation of two modules vs. case temperature

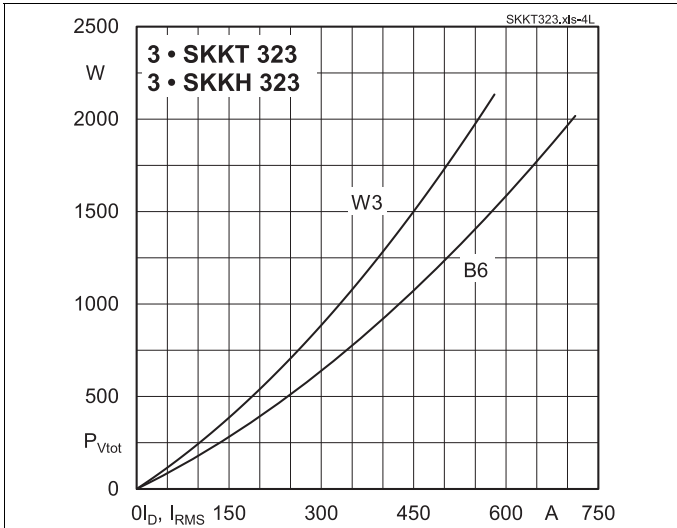

Fig. 4L: Power dissipation of three modules vs. direct and rms current

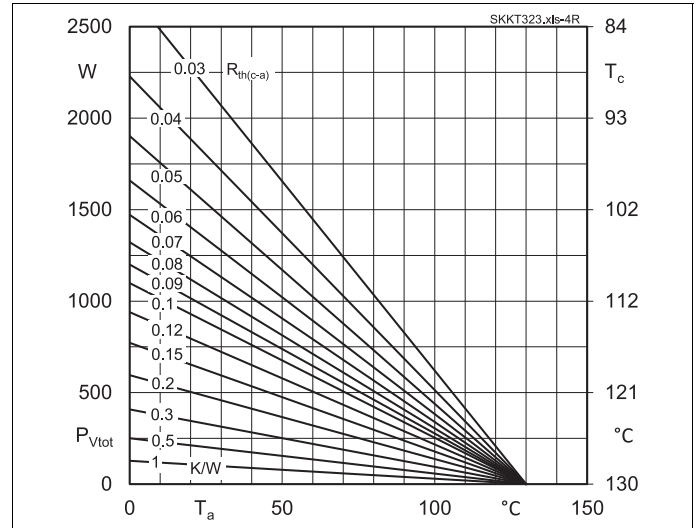

Fig. 4R: Power dissipation of three modules vs. case temperature

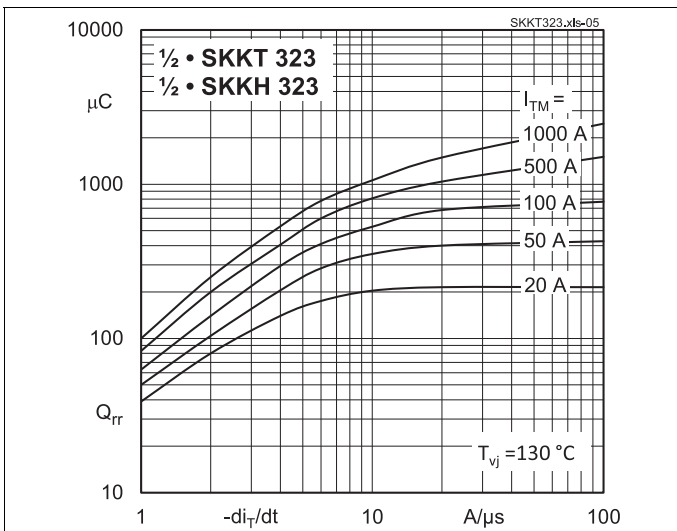

Fig. 5: Recovered charge vs. current decrease

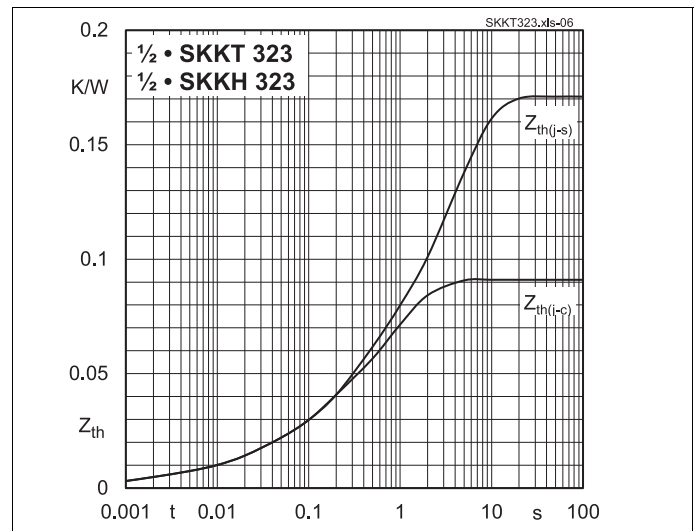

Fig. 6: Transient thermal impedance vs. time

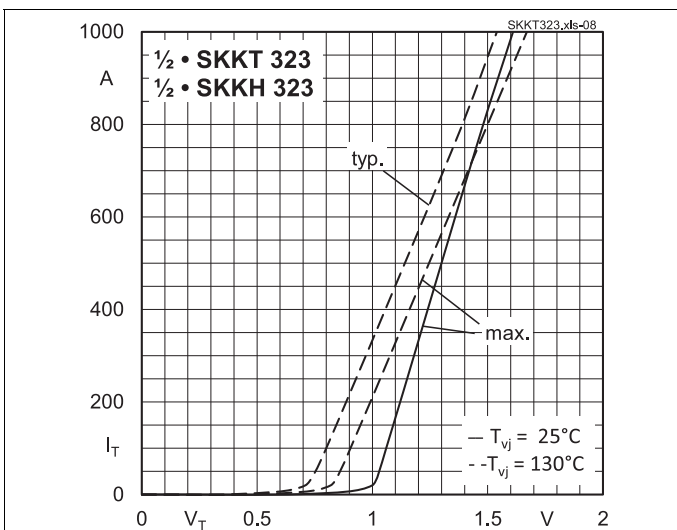

Fig. 7: On-state characteristics

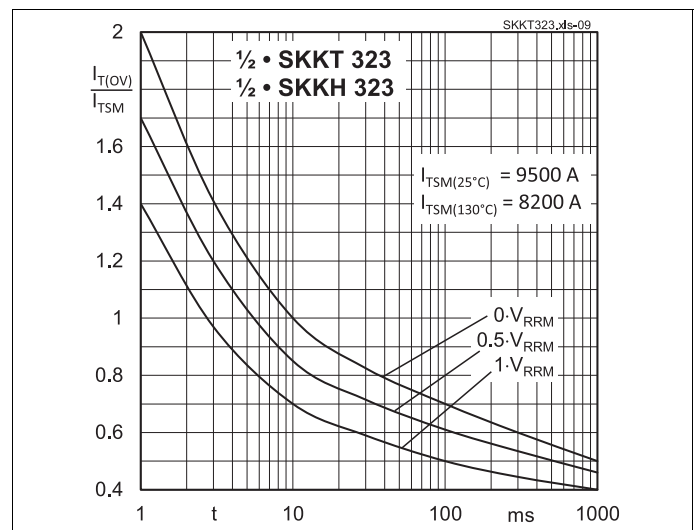

Fig. 8: Surge overload current vs. time

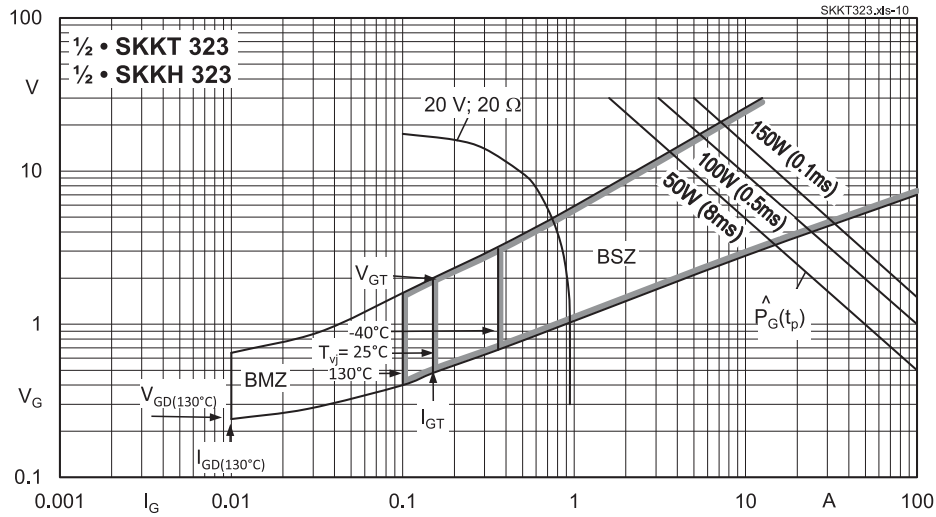
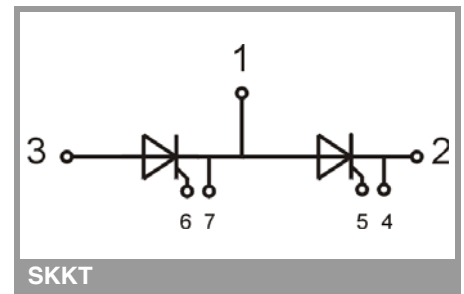
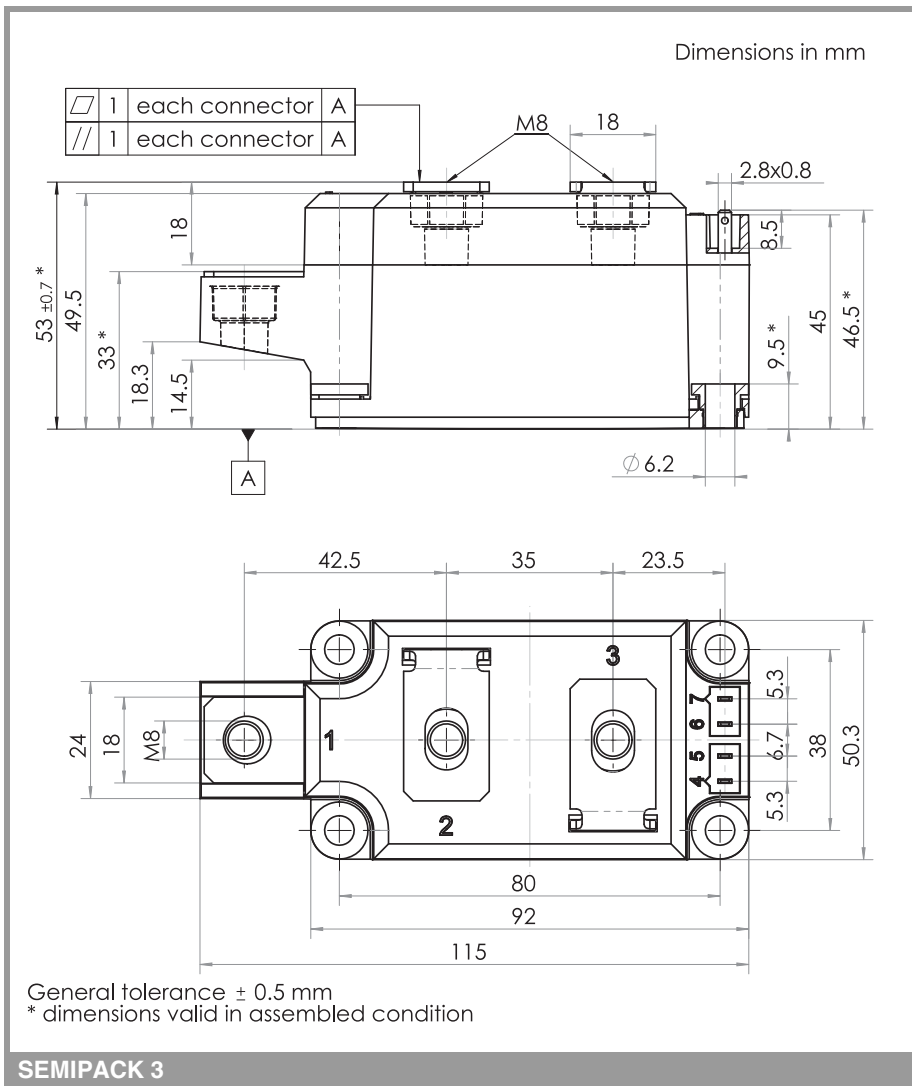

Fig. 9: Gate trigger characteristics



This is an electrostatic discharge sensitive device (ESDS), international standard IEC 60747-1, chapter IX.

*IMPORTANT INFORMATION AND WARNINGS

The specifications of SEMIKRON products may not be considered as guarantee or assurance of product characteristics ("Beschaffenheitsgarantie"). The specifications of SEMIKRON products describe only the usual characteristics of products to be expected in

typical applications, which may still vary depending on the specific application. Therefore, products must be tested for the respective application in advance. Application adjustments may be necessary. The user of SEMIKRON products is responsible for the safety of their applications embedding SEMIKRON products and must take adequate safety measures to prevent the applications from causing a physical injury, fire or other problem if any of SEMIKRON products become faulty. The user is responsible to make sure that the application design is compliant with all applicable laws, regulations, norms and standards. Except as otherwise explicitly approved by SEMIKRON in a written document signed by authorized representatives of SEMIKRON, SEMIKRON products may not be used in any applications where a failure of the product or any consequences of the use thereof can reasonably be expected to result in personal injury. No representation or warranty is given and no liability is assumed with respect to the accuracy, completeness and/or use of any information herein, including without limitation, warranties of non-infringement of intellectual property rights of any third party. SEMIKRON does not assume any liability arising out of the applications or use of any product; neither does it convey any license under its patent rights, copyrights, trade secrets or other intellectual property rights, nor the rights of others. SEMIKRON makes no representation or warranty of non-infringement or alleged non-infringement of intellectual property rights of any third party which may arise from applications. Due to technical requirements our products may contain dangerous substances. For information on the types in question please contact the nearest SEMIKRON sales office. This document supersedes and replaces all information previously supplied and may be superseded by updates. SEMIKRON reserves the right to make changes.