

SKKT 105, SKKH 105



SEMIPACK[®] 1

Thyristor / Diode Modules

SKKT 105

SKKH 105

Features

- Heat transfer through aluminium oxide ceramic isolated metal baseplate
- Hard soldered joints for high reliability
- UL recognized, file no. E 63 532

Typical Applications

- DC motor control (e. g. for machine tools)
- AC motor soft starters
- Temperature control (e. g. for ovens, chemical processes)
- Professional light dimming (studios, theaters)

1) See the assembly instructions

V_{RSM} V	V_{RRM}, V_{DRM} V	$I_{TRMS} = 180$ A (maximum value for continuous operation) $I_{TAV} = 106$ A (sin. 180; $T_c = 85$ °C)	
500	400		SKKH 105/04D
700	600	SKKT 105/06E	
900	800	SKKT 105/08E	SKKH 105/08D
1300	1200	SKKT 105/12E	SKKH 105/12E
1500	1400	SKKT 105/14E	SKKH 105/14E
1700	1600	SKKT 105/16E	SKKH 105/16E
1900	1800	SKKT 105/18E	SKKH 105/18E

Symbol	Conditions	Values	Units
I_{TAV}	sin. 180; $T_c = 85$ (100) °C;	106 (78)	A
I_D	P3/180F; $T_a = 35$ °C; B2 / B6	145 / 180	A
	P16/200F; $T_a = 35$ °C; B2 / B6	190 / 260	A
I_{RMS}	P3/180F; $T_a = 35$ °C; W1 / W3	200 / 3 * 140	A
I_{TSM}	$T_{vj} = 25$ °C; 10 ms	2250	A
	$T_{vj} = 130$ °C; 10 ms	1900	A
i^2t	$T_{vj} = 25$ °C; 8,3 ... 10 ms	25000	A ² s
	$T_{vj} = 130$ °C; 8,3 ... 10 ms	18000	A ² s
V_T	$T_{vj} = 25$ °C; $I_T = 300$ A	max. 1,65	V
$V_{T(TO)}$	$T_{vj} = 130$ °C	max. 0,9	V
r_T	$T_{vj} = 130$ °C	max. 2	mΩ
I_{DD}, I_{RD}	$T_{vj} = 130$ °C; $V_{RD} = V_{RRM}, V_{DD} = V_{DRM}$	max. 20	mA
t_{gd}	$T_{vj} = 25$ °C; $I_G = 1$ A; $di_G/dt = 1$ A/μs	1	μs
t_{gr}	$V_D = 0,67 * V_{DRM}$	2	μs
$(di/dt)_{cr}$	$T_{vj} = 130$ °C	max. 150	A/μs
$(dv/dt)_{cr}$	$T_{vj} = 130$ °C; SKK ...D / SKK ...E	max. 500 / 1000	V/μs
t_q	$T_{vj} = 130$ °C ,	100	μs
I_H	$T_{vj} = 25$ °C; typ. / max.	150 / 250	mA
I_L	$T_{vj} = 25$ °C; $R_G = 33$ Ω; typ. / max.	300 / 600	mA
V_{GT}	$T_{vj} = 25$ °C; d.c.	min. 3	V
I_{GT}	$T_{vj} = 25$ °C; d.c.	min. 150	mA
V_{GD}	$T_{vj} = 130$ °C; d.c.	max. 0,25	V
I_{GD}	$T_{vj} = 130$ °C; d.c.	max. 6	mA
$R_{th(j-c)}$	cont.; per thyristor / per module	0,28 / 0,14	K/W
$R_{th(j-c)}$	sin. 180; per thyristor / per module	0,3 / 0,15	K/W
$R_{th(j-c)}$	rec.120; per thyristor / per module	0,32 / 0,16	K/W
$R_{th(c-s)}$	per thyristor / per module	0,2 / 0,1	K/W
T_{vj}		- 40 ... + 130	°C
T_{stg}		- 40 ... + 125	°C
V_{isol}	a. c. 50 Hz; r.m.s.; 1 s / 1 min.	3600 / 3000	V~
M_s	to heatsink	5 ± 15 % ¹⁾	Nm
M_t	to terminals	5 ± 15 %	Nm
a		$5 * 9,81$	m/s ²
m	approx.	95	g
Case	SKKT	A 5	
	SKKH	A 6	

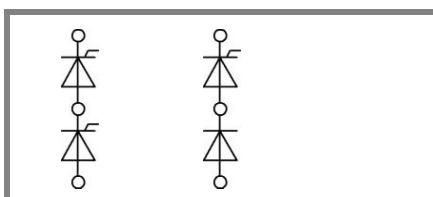

SKKT

SKKH

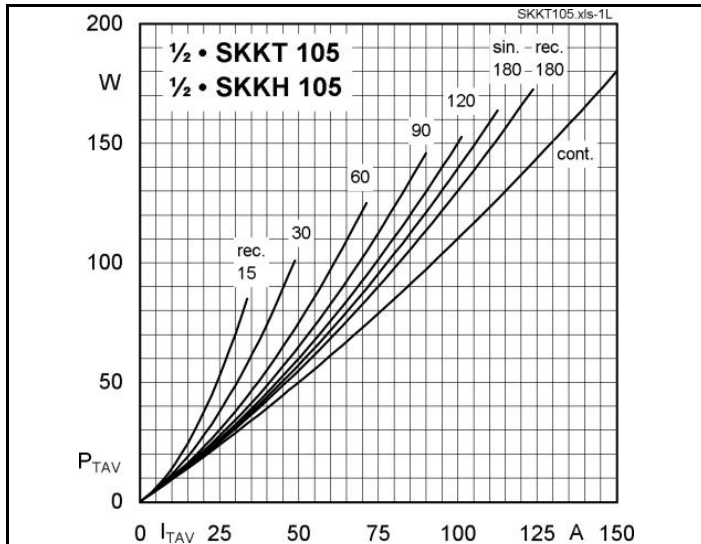

Fig. 1L Power dissipation per thyristor vs. on-state current

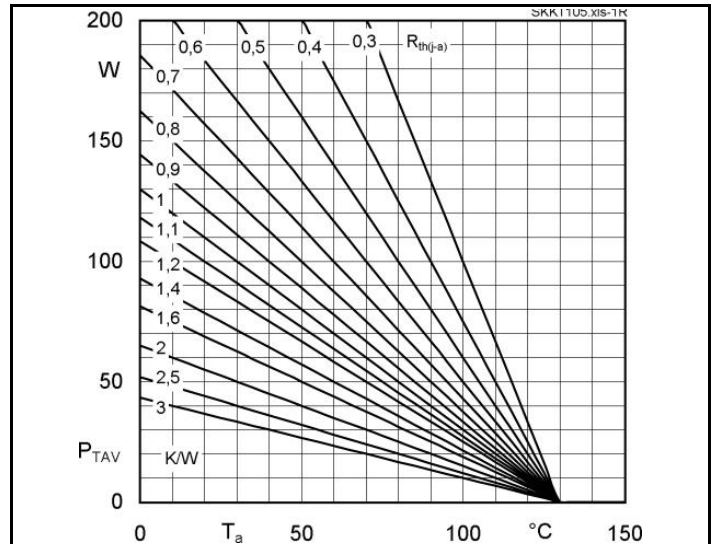

Fig. 1R Power dissipation per thyristor vs. ambient temp.

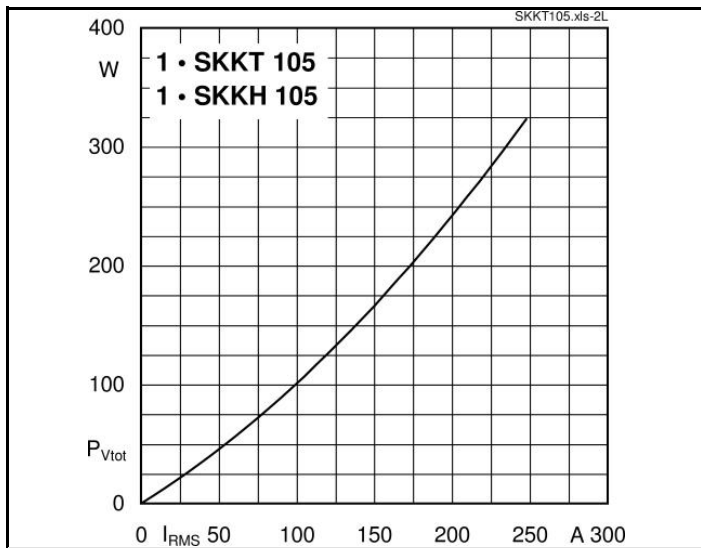

Fig. 2L Power dissipation per module vs. rms current

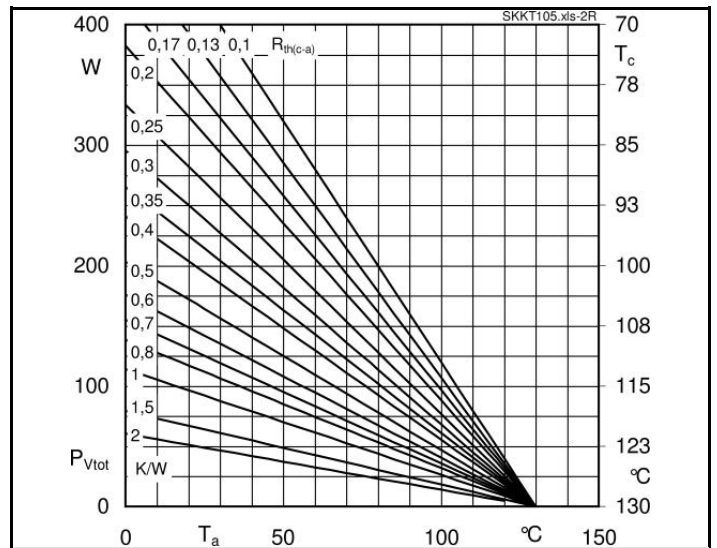

Fig. 2R Power dissipation per module vs. case temp.

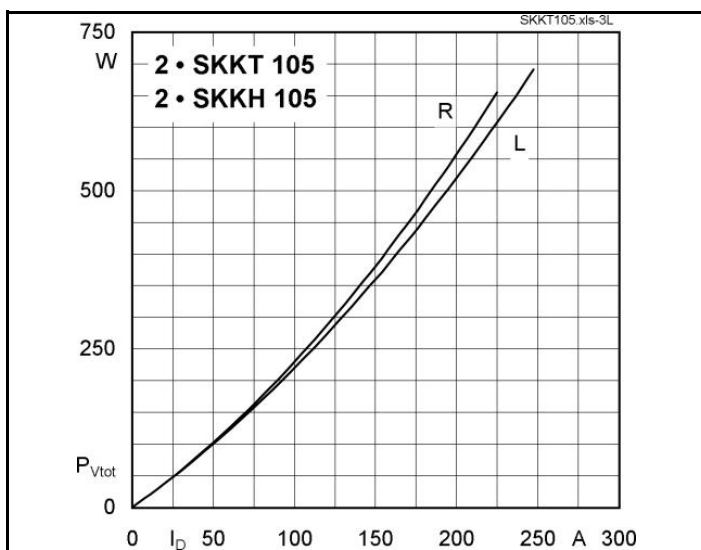

Fig. 3L Power dissipation of two modules vs. direct current

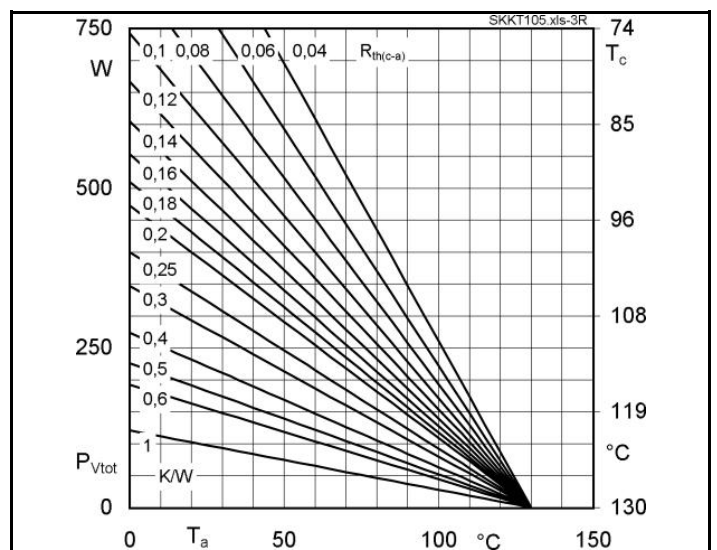
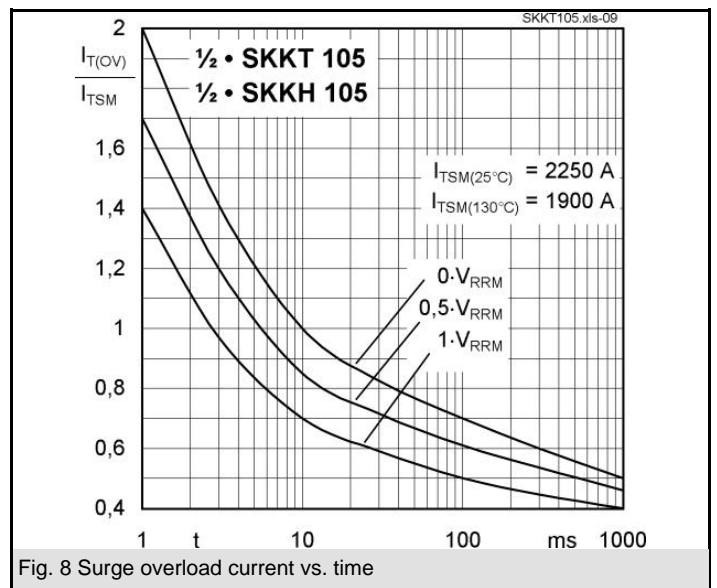
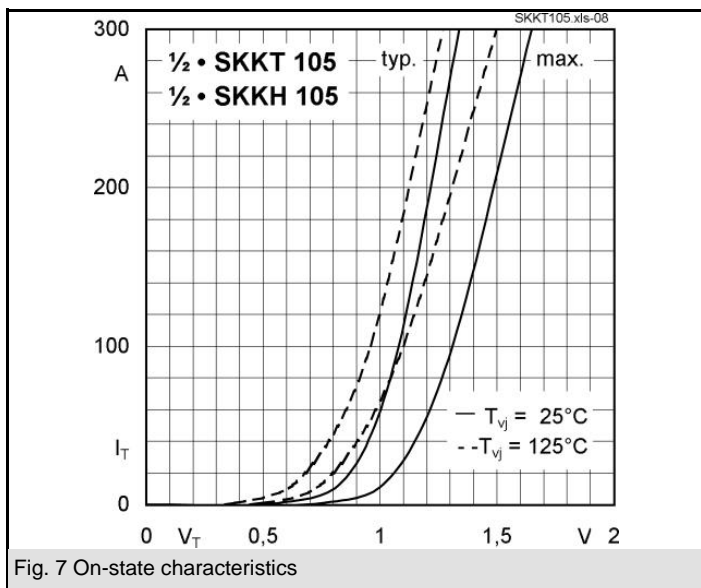
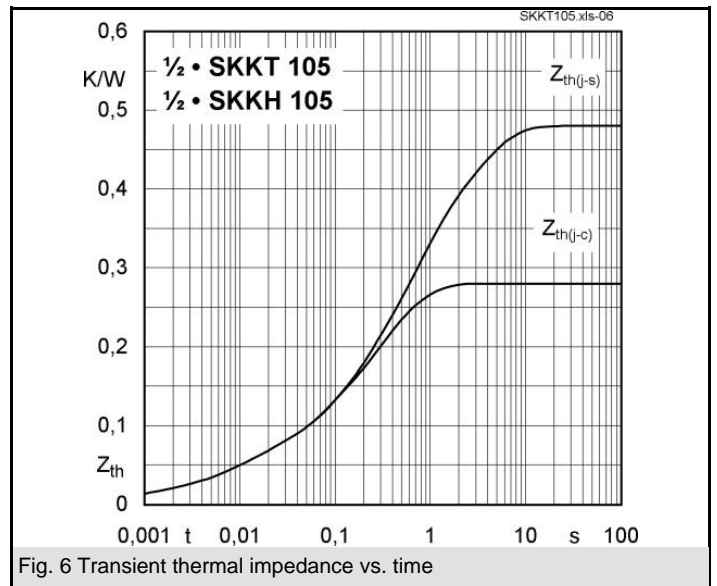
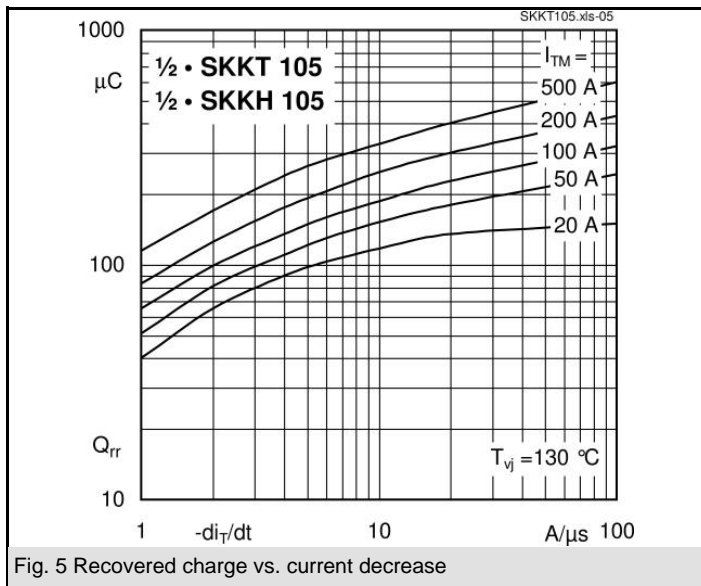
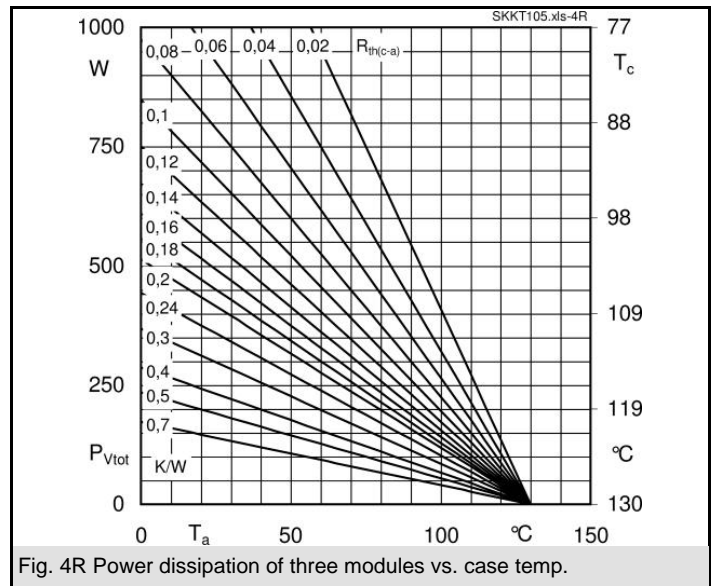
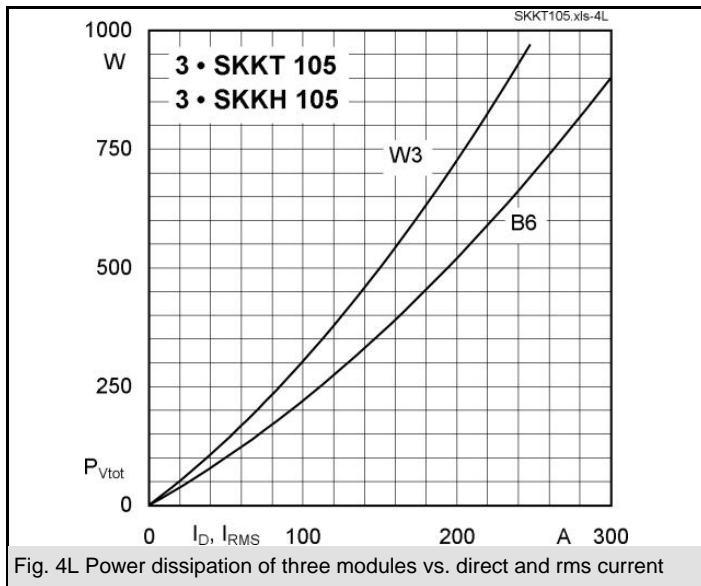
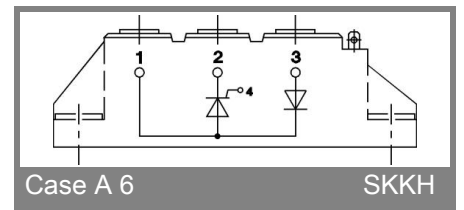
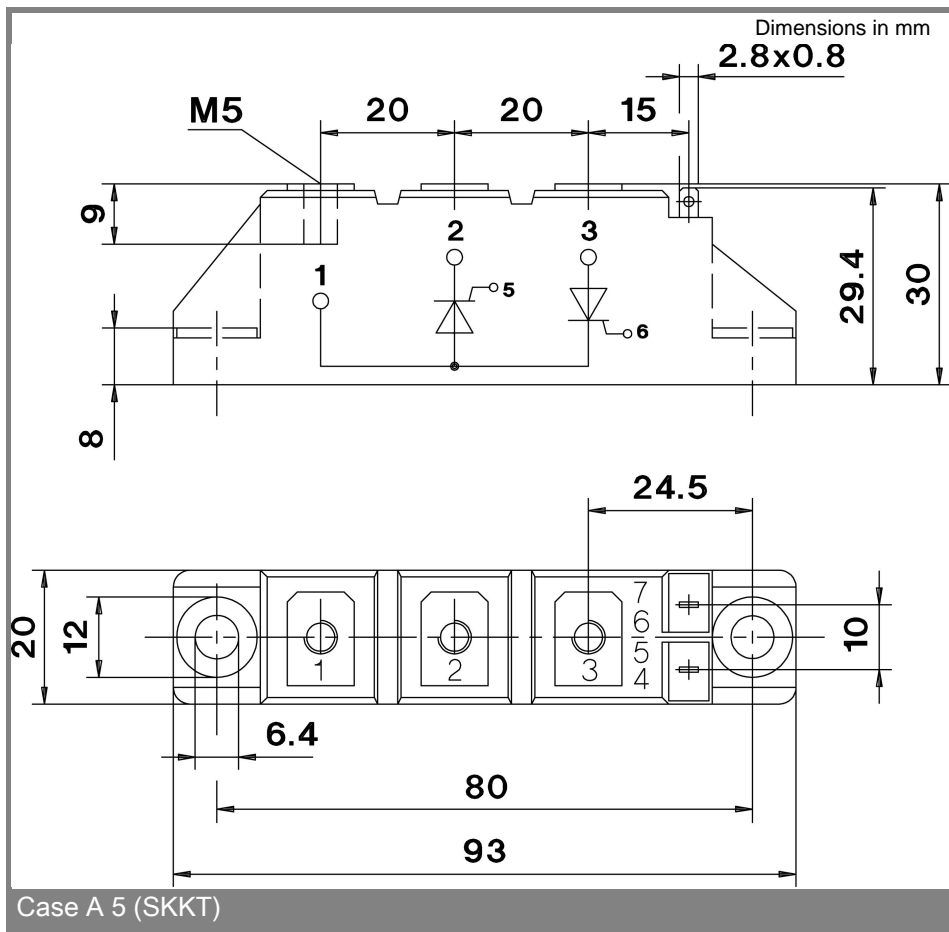
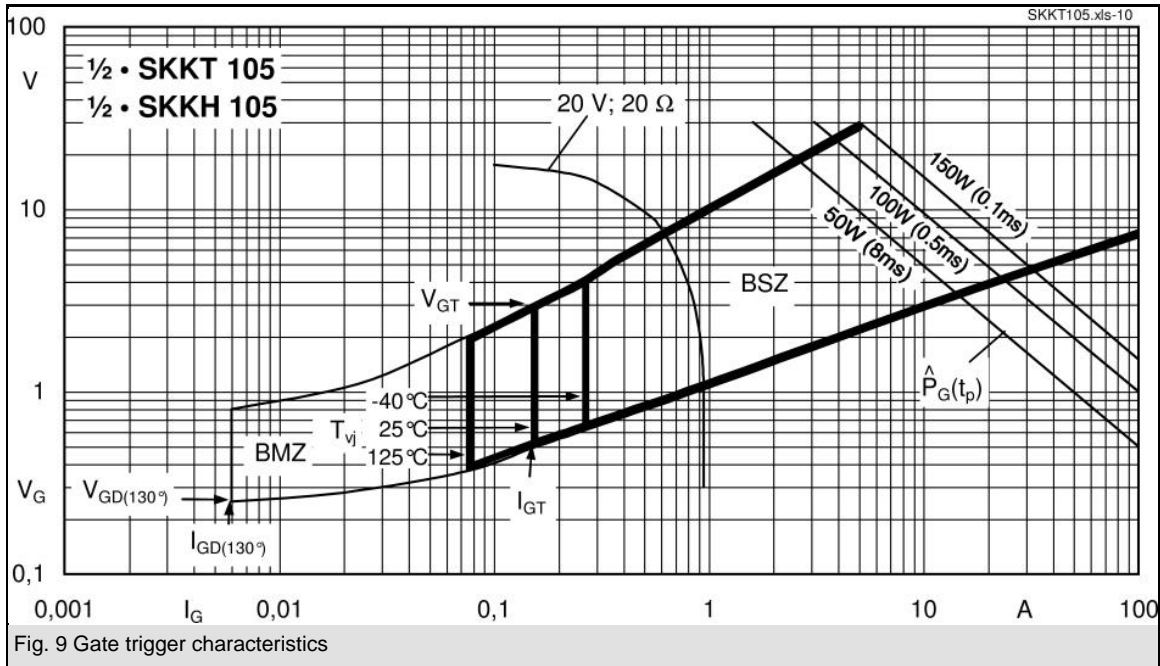

Fig. 3R Power dissipation of two modules vs. case temp.

SKKT 105, SKKH 105





This technical information specifies semiconductor devices but promises no characteristics. No warranty or guarantee expressed or implied is made regarding delivery, performance or suitability.