

Thyristor Modules

AMKT 460



V_{RSM} V	V_{RRM}, V_{DRM} V	$I_{TRMS} = 800$ A (maximum value for continuous operation) $I_{TAV} = 460$ A (sin 180; $T_C = 85$ °C)	
1700 2300	1600 2200	AMKT 460-16E AMKT 460-22E H4	

Symbols and parameters			Values	Units
I_{TAV}	Average on-state current	sin. 180; $T_C = 85$ (100)°C	460 (335)	A
I_{TSM}	Surge on-state current	$T_{vj} = 25$ °C; 10 ms	18000	A
		$T_{vj} = 130$ °C; 10 ms	15500	A
I^2t	I^2t value, rating for fusing	$T_{vj} = 25$ °C; 10 ms	1620000	A ² s
		$T_{vj} = 130$ °C; 10 ms	1200000	A ² s
V_T	On-state voltage	$T_{vj} = 25$ °C; $I_T = 1400$ A	max. 1.6	V
$V_{T(TO)}$	On-state threshold voltage	$T_{vj} = 130$ °C	max. 0.88	V
r_T	On-state slope resistance	$T_{vj} = 130$ °C	max. 0.45	mΩ
$I_{DD}; I_{RD}$	Forward off-state current; Direct reverse current	$T_{vj} = 130$ °C, $V_{RD} = V_{RRM}$; $V_{DD} = V_{DRM}$	max. 240	mA
t_{gd}	Gate controlled turn-on delay time	$T_{vj} = 25$ °C; $I_G = 1$ A; $di_G/dt = 1$ A/μs	1	μs
t_{gr}	Gate controlled rise time	$V_D = 0.67 * V_{DRM}$	2	μs
$(di/dt)_{cr}$	Critical rate of rise of on-state current	$T_{vj} = 130$ °C	max. 250	A/μs
$(dv/dt)_{cr}$	Critical rate of rise of off-state voltage	$T_{vj} = 130$ °C	max. 1000	V/μs
t_q	Turn-off time	$T_{vj} = 130$ °C	100 ... 200	μs
I_H	Holding current	$T_{vj} = 25$ °C; typ. / max	150 / 500	mA
I_L	Latching current	$T_{vj} = 25$ °C; $R_G = 33$ Ω; typ. / max	300 / 2000	mA
V_{GT}	Gate trigger voltage	$T_{vj} = 25$ °C; d.c.	min. 3	V
I_{GT}	Gate trigger current	$T_{vj} = 25$ °C; d.c.	min. 200	mA
V_{GD}	Gate non-trigger voltage	$T_{vj} = 130$ °C; d.c.	max. 0.25	V
I_{GD}	Gate non-trigger current	$T_{vj} = 130$ °C; d.c.	max. 10	mA
$R_{th(j-c)}$	Thermal resistance, junction to case	cont. DC; per chip / per module	0.072 / 0.035	K/W
		sin.180; per chip / per module	0.074 / 0.037	K/W
		rec.120; per chip / per module	0.078 / 0.039	K/W
$R_{th(c-s)}$	Thermal resistance, junction to heatsink	per chip / per module	0.02 / 0.01	K/W
T_{vj}	Virtual junction temperature		-40 ... +130	°C
T_{stg}	Storage temperature range		-40 ... +125	°C
V_{ISOL}	Insulation test voltage (r.m.s.)	a.c. 50 Hz; r.m.s.; 1s / 1min.	3600 / 3000	V~
		a.c. 50 Hz; r.m.s.; 1s / 1min.for...H4	4800 / 4000	V~
M_s	Mounting torque on heatsink	min / max	5 ± 15 %	Nm
M_t	Mounting torque for terminals	min / max	12 ± 15 %	Nm
a	Maximum allowable acceleration		5*9.81	m/s ²
W	Weight	approx.	1400	g

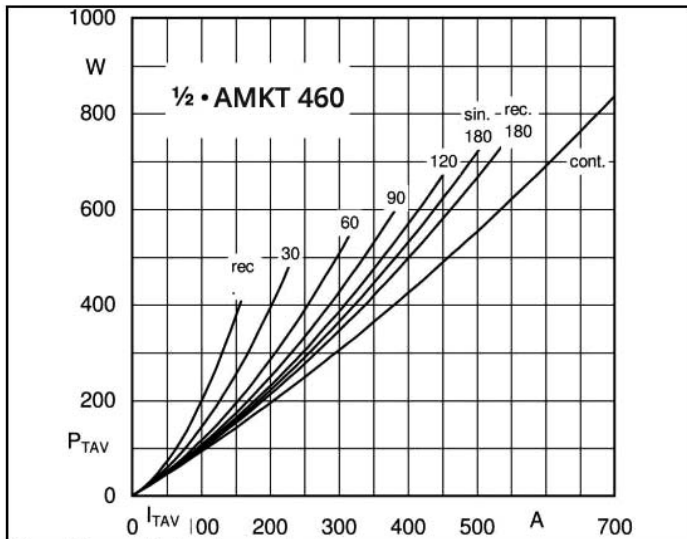

Fig. 1I Power dissipation per thyristor vs. on-state current

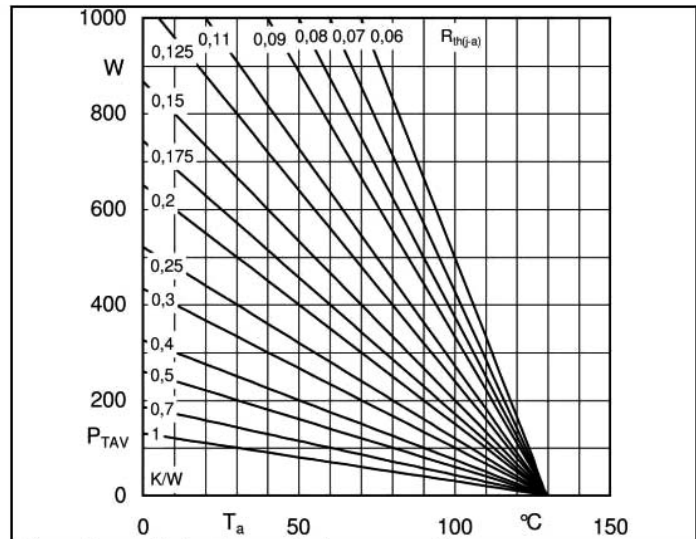

Fig. 1r Power dissipation per thyristor vs. ambient temperature

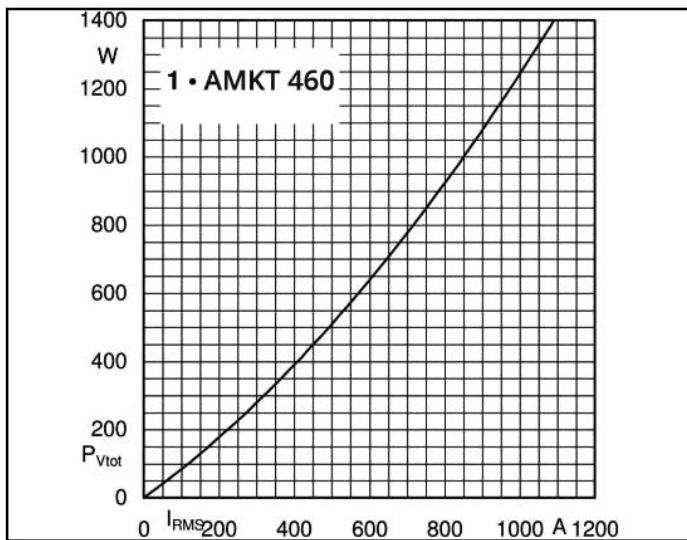

Fig. 2I Power dissipation per module vs. rms current

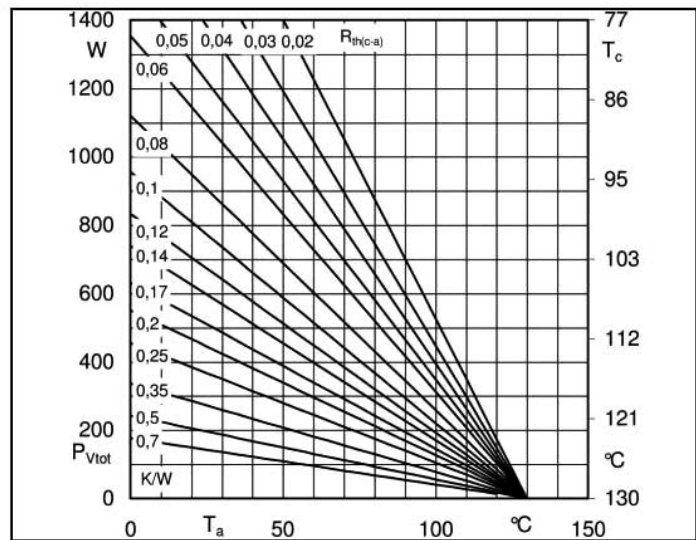

Fig. 2R Power dissipation per modules vs. case temp.

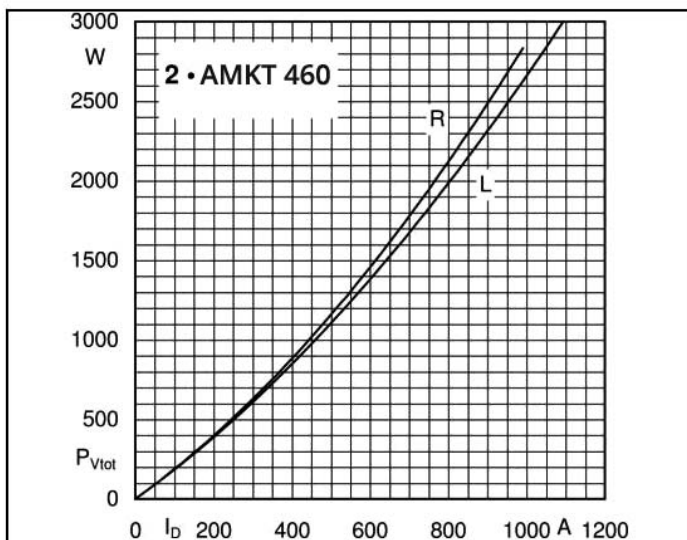

Fig. 3L Power dissipation of two modules vs. direct current

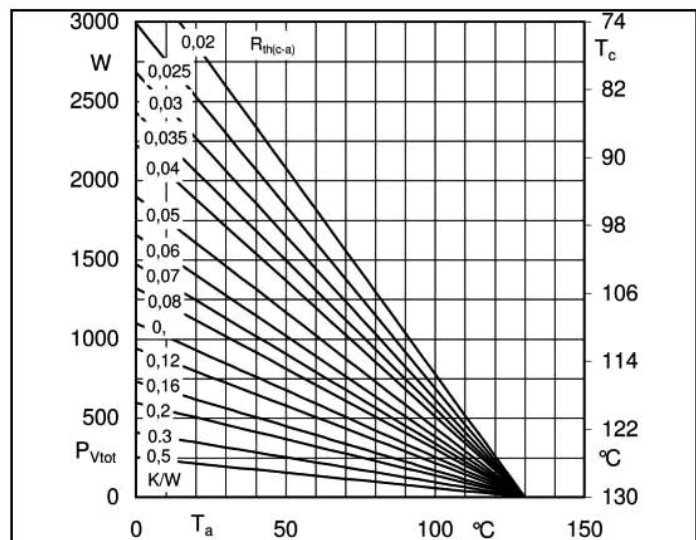
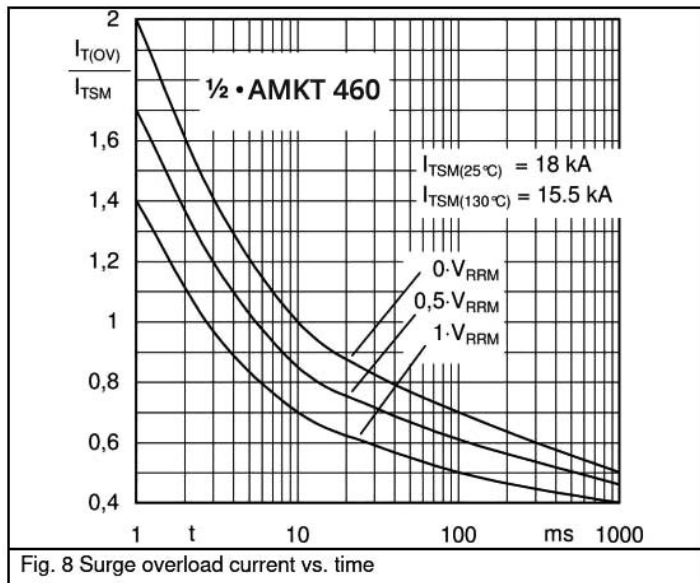
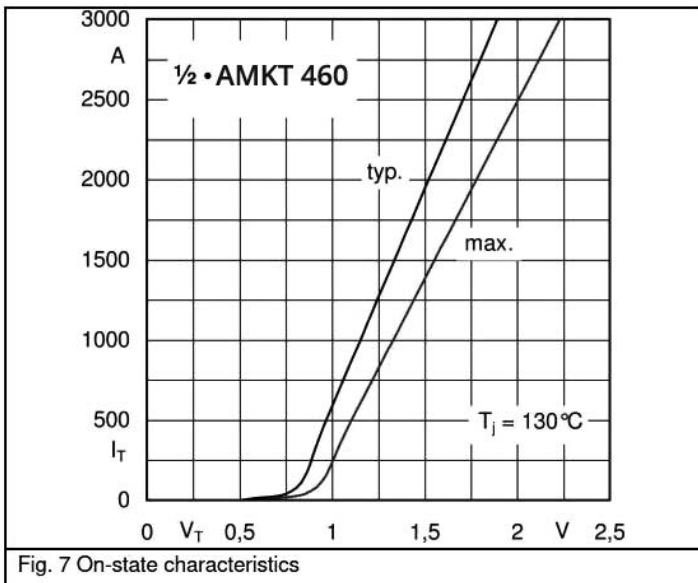
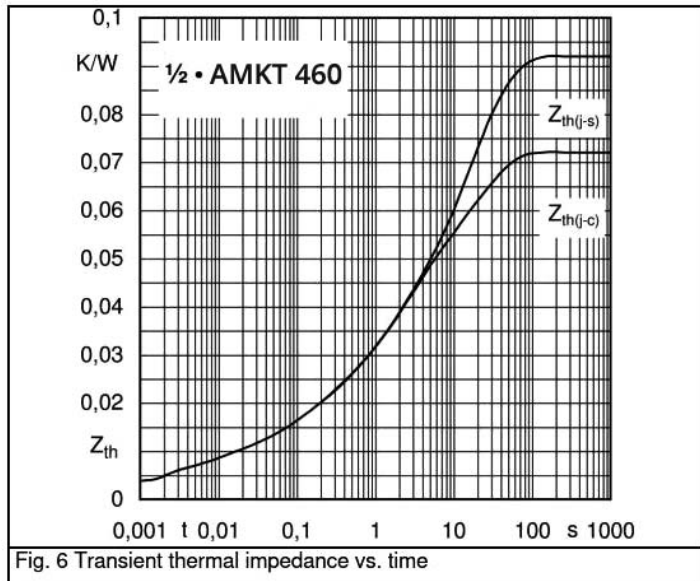
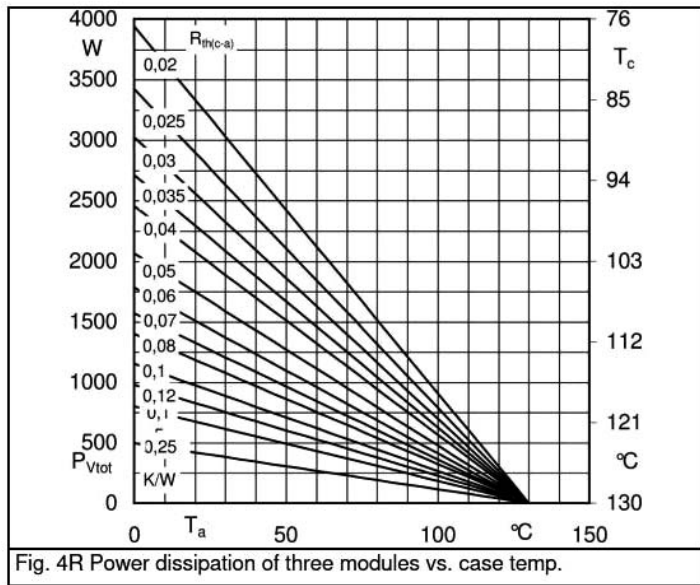
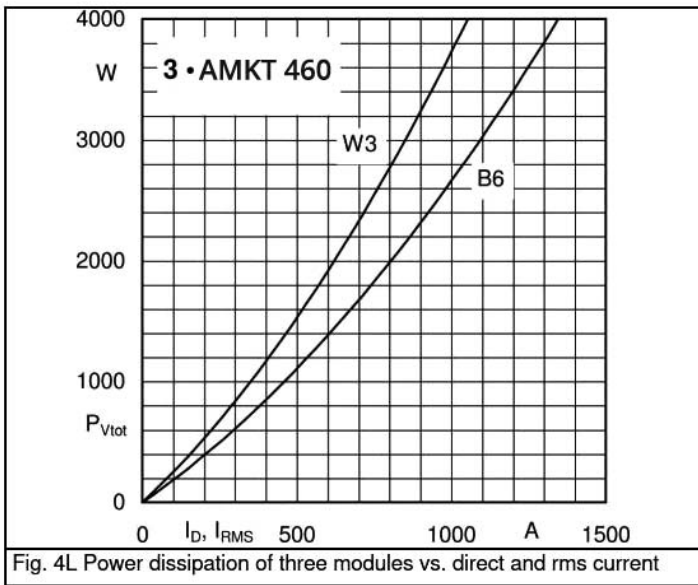
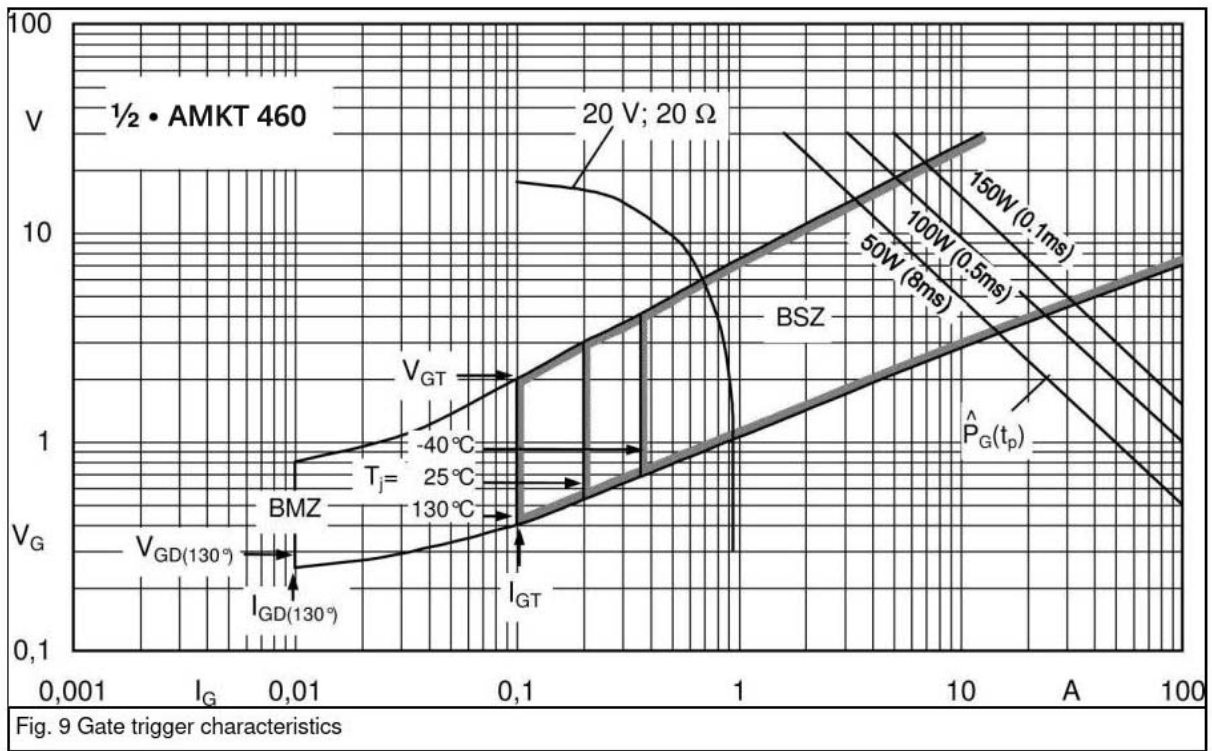
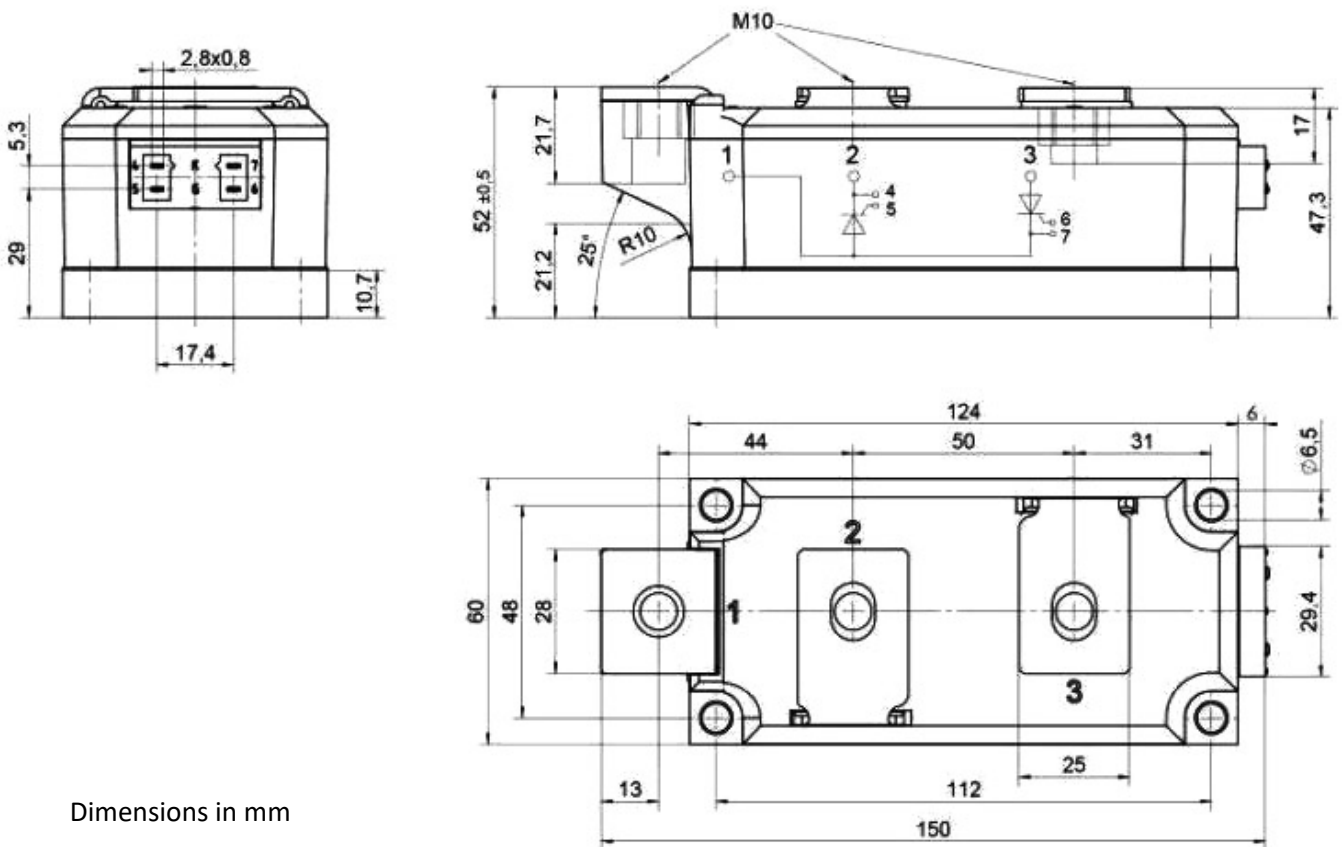

Fig. 3R Power dissipation of two modules vs. case temp.





DIMENSIONS



TOPOLOGY OF INTERNAL CONNECTION

