

IHM-B module with Trench/Fieldstop IGBT4 and emitter controlled 4 diode

Features

- Electrical features
 - $V_{CES} = 3300\text{ V}$
 - $I_{C\text{nom}} = 2400\text{ A} / I_{CRM} = 4800\text{ A}$
 - High current density
 - High DC stability
 - High short-circuit capability
 - Low switching losses
 - Low $V_{CE,sat}$
 - $T_{vj,op} = 150^{\circ}\text{C}$
 - Trench IGBT 4
 - Unbeatable robustness
 - $V_{CE,sat}$ with positive temperature coefficient
 - Low Q_g and C_{res}
- Mechanical features
 - ALSiC base plate for increased thermal cycling capability
 - High power density
 - Isolated base plate
 - Package with CTI > 600
 - RoHS compliant



Potential applications

- High-power converters
- Medium-voltage converters
- Motor drives
- Traction drives
- UPS systems
- Active frontend (energy recovery)

Product validation

- Qualified for industrial applications according to the relevant tests of IEC 60747, 60749 and 60068

Description

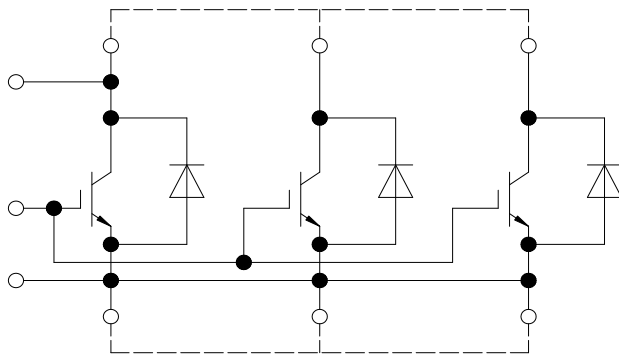

external connection
(to be done)

Table of contents

	Description	1
	Features	1
	Potential applications	1
	Product validation	1
	Table of contents	2
1	Package	3
2	IGBT, Inverter	3
3	Diode, Inverter	5
4	Characteristics diagrams	7
5	Circuit diagram	11
6	Package outlines	11
7	Module label code	12
	Revision history	13
	Disclaimer	14

1 Package

Table 1 Insulation coordination

Parameter	Symbol	Note or test condition	Values	Unit
Isolation test voltage	V_{ISOL}	RMS, $f = 50$ Hz	6.0	kV
Partial discharge extinction voltage	V_{isol}	RMS, $f = 50$ Hz, $Q_{PD} \leq 10$ pC	2.6	kV
DC stability	$V_{CE(D)}$	$T_{vj} = 25$ °C, 100 Fit	2100	V
Material of module baseplate			AlSiC	
Creepage distance	d_{Creep}	terminal to heatsink	32.2	mm
Clearance	d_{Clear}	terminal to heatsink	19.1	mm
Comparative tracking index	CTI		> 600	

Table 2 Characteristic values

Parameter	Symbol	Note or test condition	Values			Unit	
			Min.	Typ.	Max.		
Stray inductance module	L_{sCE}			6		nH	
Module lead resistance, terminals - chip	$R_{AA'+CC'}$	$T_C = 25$ °C, per switch		0.08		mΩ	
Module lead resistance, terminals - chip	$R_{CC'+EE'}$	$T_C = 25$ °C, per switch		0.095		mΩ	
Storage temperature	T_{stg}		-40		150	°C	
Mounting torque for module mounting	M	- Mounting according to valid application note	M6, Screw	4.25		5.75	Nm
Terminal connection torque	M	- Mounting according to valid application note	M4, Screw	1.8		2.1	Nm
			M8, Screw	8		10	
Weight	G			1200		g	

2 IGBT, Inverter

Table 3 Maximum rated values

Parameter	Symbol	Note or test condition	Values	Unit	
Collector-emitter voltage	V_{CES}		$T_{vj} = -40$ °C	3300	V
			$T_{vj} = 150$ °C	3300	
Continuous DC collector current	I_{CDC}	$T_{vj\ max} = 150$ °C	$T_C = 105$ °C	2400	A
Repetitive peak collector current	I_{CRM}	t_p limited by $T_{vj\ op}$		4800	A

(table continues...)

Table 3 (continued) Maximum rated values

Parameter	Symbol	Note or test condition	Values	Unit
Gate-emitter peak voltage	V_{GES}		±20	V

Table 4 Characteristic values

Parameter	Symbol	Note or test condition	Values			Unit
			Min.	Typ.	Max.	
Collector-emitter saturation voltage	$V_{CE\ sat}$	$I_C = 2400\ A, V_{GE} = 15\ V$	$T_{vj} = 25\ ^\circ C$	2.40	2.65	V
			$T_{vj} = 125\ ^\circ C$	2.95		
			$T_{vj} = 150\ ^\circ C$	3.10	3.25	
Gate threshold voltage	V_{GEth}	$I_C = 94\ mA, V_{CE} = V_{GE}, T_{vj} = 25\ ^\circ C$	5.20	5.80	6.40	V
Gate charge	Q_G	$V_{GE} = \pm 15\ V, V_{CC} = 1800\ V$		40		μC
Internal gate resistor	R_{Gint}	$T_{vj} = 25\ ^\circ C$		0.5		Ω
Input capacitance	C_{ies}	$f = 1000\ kHz, T_{vj} = 25\ ^\circ C, V_{CE} = 25\ V, V_{GE} = 0\ V$		280		nF
Reverse transfer capacitance	C_{res}	$f = 1000\ kHz, T_{vj} = 25\ ^\circ C, V_{CE} = 25\ V, V_{GE} = 0\ V$		8		nF
Collector-emitter cut-off current	I_{CES}	$V_{CE} = 3300\ V, V_{GE} = 0\ V$	$T_{vj} = 25\ ^\circ C$		5	mA
Gate-emitter leakage current	I_{GES}	$V_{CE} = 0\ V, V_{GE} = 20\ V, T_{vj} = 25\ ^\circ C$			400	nA
Turn-on delay time (inductive load)	t_{don}	$I_C = 2400\ A, V_{CC} = 1800\ V, V_{GE} = \pm 15\ V, R_{Gon} = 0.5\ \Omega$	$T_{vj} = 25\ ^\circ C$	0.560		μs
			$T_{vj} = 125\ ^\circ C$	0.660		
			$T_{vj} = 150\ ^\circ C$	0.670		
Rise time (inductive load)	t_r	$I_C = 2400\ A, V_{CC} = 1800\ V, V_{GE} = \pm 15\ V, R_{Gon} = 0.5\ \Omega$	$T_{vj} = 25\ ^\circ C$	0.250		μs
			$T_{vj} = 125\ ^\circ C$	0.270		
			$T_{vj} = 150\ ^\circ C$	0.290		
Turn-off delay time (inductive load)	t_{doff}	$I_C = 2400\ A, V_{CC} = 1800\ V, V_{GE} = \pm 15\ V, R_{Goff} = 3.3\ \Omega$	$T_{vj} = 25\ ^\circ C$	4.000		μs
			$T_{vj} = 125\ ^\circ C$	4.300		
			$T_{vj} = 150\ ^\circ C$	4.300		
Fall time (inductive load)	t_f	$I_C = 2400\ A, V_{CC} = 1800\ V, V_{GE} = \pm 15\ V, R_{Goff} = 3.3\ \Omega$	$T_{vj} = 25\ ^\circ C$	0.540		μs
			$T_{vj} = 125\ ^\circ C$	1.180		
			$T_{vj} = 150\ ^\circ C$	1.400		
Turn-on time (resistive load)	t_{on_R}	$I_C = 500\ A, V_{CC} = 2000\ V, V_{GE} = \pm 15\ V, R_{Gon} = 0.5\ \Omega$	$T_{vj} = 25\ ^\circ C$	1.19		μs
Turn-on energy loss per pulse	E_{on}	$I_C = 2400\ A, V_{CC} = 1800\ V, L_\sigma = 85\ nH, V_{GE} = \pm 15\ V, R_{Gon} = 0.5\ \Omega, di/dt = 7600\ A/\mu s (T_{vj} = 150\ ^\circ C)$	$T_{vj} = 25\ ^\circ C$	2000		mJ
			$T_{vj} = 125\ ^\circ C$	3400		
			$T_{vj} = 150\ ^\circ C$	3900		

(table continues...)

Table 4 (continued) Characteristic values

Parameter	Symbol	Note or test condition	Values			Unit
			Min.	Typ.	Max.	
Turn-off energy loss per pulse	E_{off}	$I_C = 2400\text{ A}$, $V_{CC} = 1800\text{ V}$, $L_\sigma = 85\text{ nH}$, $V_{GE} = \pm 15\text{ V}$, $R_{Goff} = 3.3\ \Omega$, $dv/dt = 1500\text{ V}/\mu\text{s}$ ($T_{vj} = 150\text{ }^\circ\text{C}$)	$T_{vj} = 25\text{ }^\circ\text{C}$	3500		mJ
			$T_{vj} = 125\text{ }^\circ\text{C}$	4600		
			$T_{vj} = 150\text{ }^\circ\text{C}$	4950		
SC data	I_{SC}	$V_{GE} \leq 15\text{ V}$, $V_{CC} = 2400\text{ V}$, $V_{CEmax} = V_{CES} - L_{sCE} * di/dt$	$t_p \leq 10\ \mu\text{s}$, $T_{vj} \leq 150\text{ }^\circ\text{C}$	9600		A
Thermal resistance, junction to case	R_{thJC}	per IGBT			5.50	K/kW
Thermal resistance, case to heat sink	R_{thCH}	per IGBT		4.30		K/kW
Temperature under switching conditions	T_{vjop}		-40		150	$^\circ\text{C}$

3 Diode, Inverter

Table 5 Maximum rated values

Parameter	Symbol	Note or test condition	Values	Unit	
Repetitive peak reverse voltage	V_{RRM}		$T_{vj} = -40\text{ }^\circ\text{C}$	3300	V
			$T_{vj} = 150\text{ }^\circ\text{C}$	3300	
Continuous DC forward current	I_F		2400	A	
Repetitive peak forward current	I_{FRM}	$t_p = 1\text{ ms}$	4800	A	
I^2t - value	I^2t	$t_p = 10\text{ ms}$, $V_R = 0\text{ V}$	$T_{vj} = 125\text{ }^\circ\text{C}$	1230	kA ² s
			$T_{vj} = 150\text{ }^\circ\text{C}$	1110	
Maximum power dissipation	P_{RQM}		$T_{vj} = 150\text{ }^\circ\text{C}$	5400	kW
Minimum turn-on time	t_{onmin}		10	μs	

Table 6 Characteristic values

Parameter	Symbol	Note or test condition	Values			Unit	
			Min.	Typ.	Max.		
Forward voltage	V_F	$I_F = 2400\text{ A}$, $V_{GE} = 0\text{ V}$	$T_{vj} = 25\text{ }^\circ\text{C}$		2.90	3.30	V
			$T_{vj} = 125\text{ }^\circ\text{C}$		2.60		
			$T_{vj} = 150\text{ }^\circ\text{C}$		2.50	2.80	

(table continues...)

Table 6 (continued) Characteristic values

Parameter	Symbol	Note or test condition	Values			Unit
			Min.	Typ.	Max.	
Peak reverse recovery current	I_{RM}	$V_{CC} = 1800\text{ V}$, $I_F = 2400\text{ A}$, $V_{GE} = -15\text{ V}$, $-di_F/dt = 7600\text{ A}/\mu\text{s}$ ($T_{vj} = 150\text{ }^\circ\text{C}$)	$T_{vj} = 25\text{ }^\circ\text{C}$	2440		A
			$T_{vj} = 125\text{ }^\circ\text{C}$	2820		
			$T_{vj} = 150\text{ }^\circ\text{C}$	2880		
Recovered charge	Q_r	$V_{CC} = 1800\text{ V}$, $I_F = 2400\text{ A}$, $V_{GE} = -15\text{ V}$, $-di_F/dt = 7600\text{ A}/\mu\text{s}$ ($T_{vj} = 150\text{ }^\circ\text{C}$)	$T_{vj} = 25\text{ }^\circ\text{C}$	1100		μC
			$T_{vj} = 125\text{ }^\circ\text{C}$	2100		
			$T_{vj} = 150\text{ }^\circ\text{C}$	2500		
Reverse recovery energy	E_{rec}	$V_{CC} = 1800\text{ V}$, $I_F = 2400\text{ A}$, $V_{GE} = -15\text{ V}$, $-di_F/dt = 7600\text{ A}/\mu\text{s}$ ($T_{vj} = 150\text{ }^\circ\text{C}$)	$T_{vj} = 25\text{ }^\circ\text{C}$	1480		mJ
			$T_{vj} = 125\text{ }^\circ\text{C}$	2750		
			$T_{vj} = 150\text{ }^\circ\text{C}$	3200		
Thermal resistance, junction to case	R_{thJC}	per diode			10.6	K/kW
Thermal resistance, case to heat sink	R_{thCH}	per diode		5.10		K/kW
Temperature under switching conditions	$T_{vj\text{ op}}$		-40		150	$^\circ\text{C}$

4 Characteristics diagrams

Output characteristic (typical), IGBT, Inverter

$$I_C = f(V_{CE})$$

$$V_{GE} = 15 \text{ V}$$

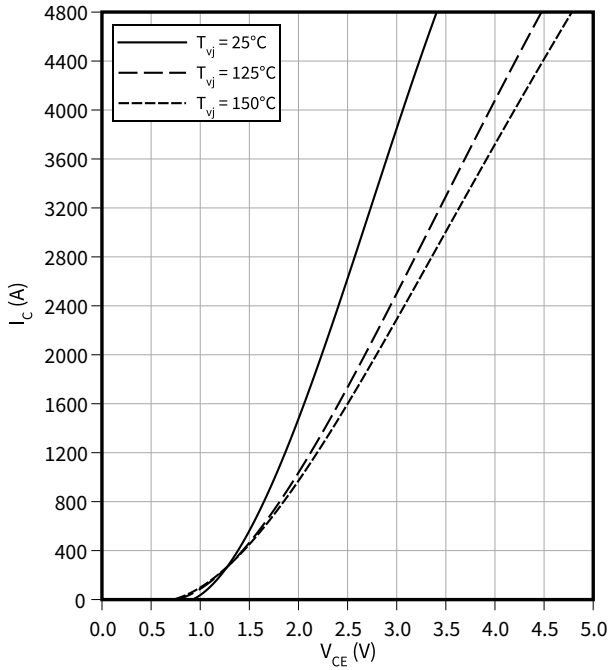

Output characteristic field (typical), IGBT, Inverter

$$I_C = f(V_{CE})$$

$$T_{vj} = 150 \text{ °C}$$

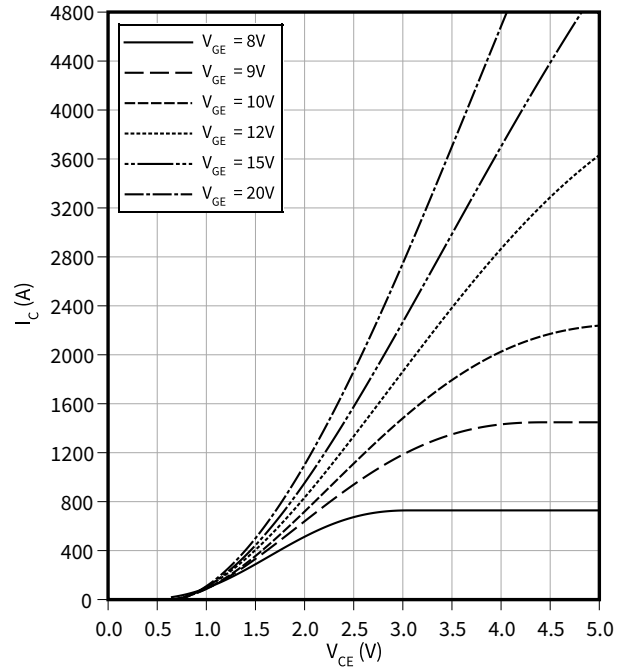

Transfer characteristic (typical), IGBT, Inverter

$$I_C = f(V_{GE})$$

$$V_{CE} = 20 \text{ V}$$

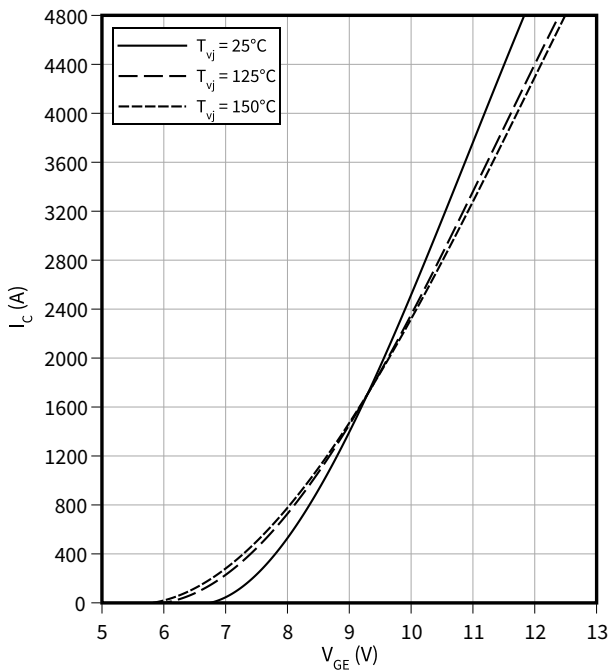

Switching losses (typical), IGBT, Inverter

$$E = f(I_C)$$

$$R_{Goff} = 3.3 \text{ } \Omega, R_{Gon} = 0.5 \text{ } \Omega, V_{CC} = 1800 \text{ V}, V_{GE} = \pm 15 \text{ V}$$

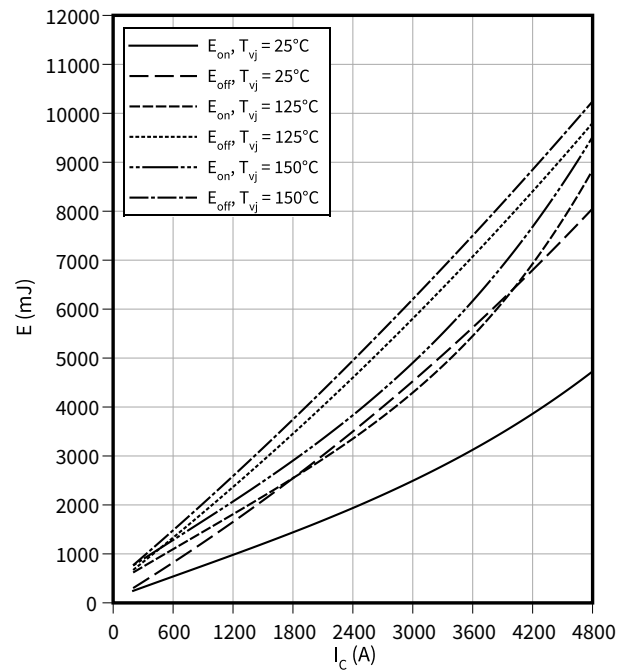

4 Characteristics diagrams

Switching losses (typical), IGBT, Inverter

$E = f(R_G)$

$I_C = 2400 \text{ A}$, $V_{CC} = 1800 \text{ V}$, $V_{GE} = \pm 15 \text{ V}$

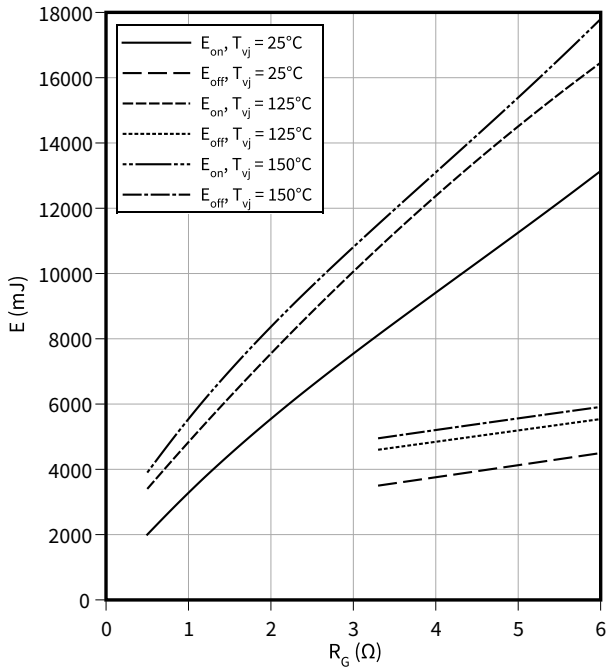

Switching times (typical), IGBT, Inverter

$t = f(I_C)$

$R_{Goff} = 3.3 \Omega$, $R_{Gon} = 0.5 \Omega$, $V_{CC} = 1800 \text{ V}$, $V_{GE} = \pm 15 \text{ V}$, $T_{vj} = 125 \text{ °C}$

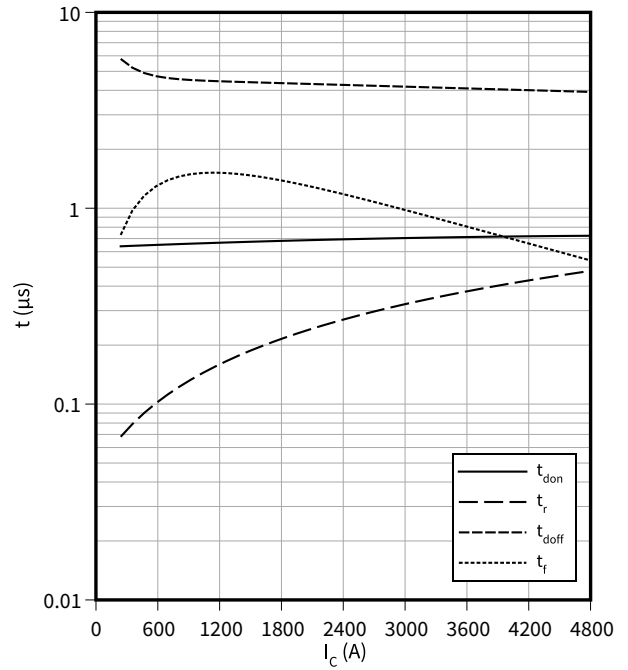

Switching times (typical), IGBT, Inverter

$t = f(R_G)$

$I_C = 2400 \text{ A}$, $V_{CC} = 1800 \text{ V}$, $V_{GE} = \pm 15 \text{ V}$, $T_{vj} = 125 \text{ °C}$

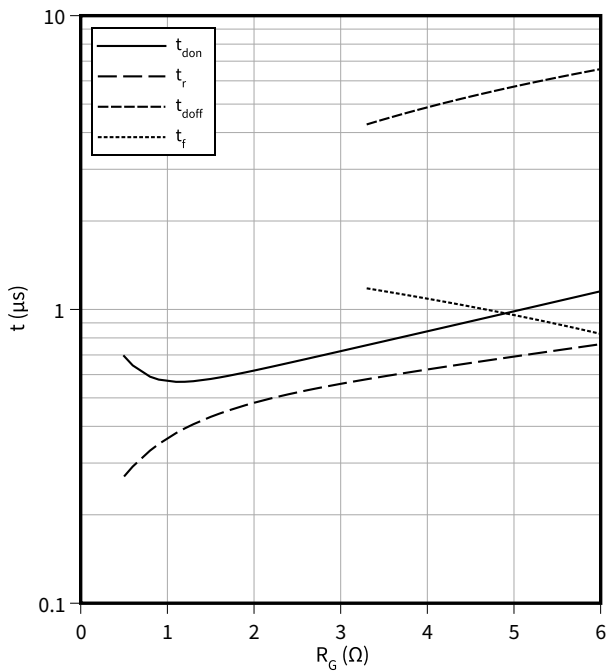

Transient thermal impedance , IGBT, Inverter

$Z_{th} = f(t)$

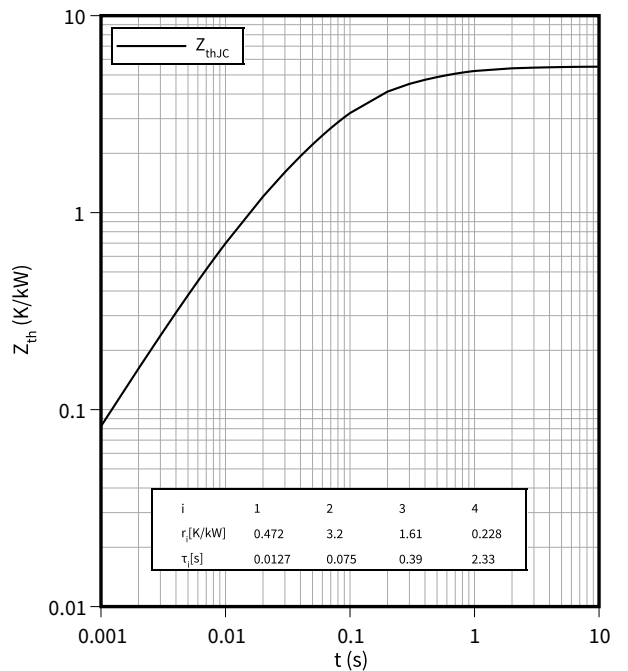

4 Characteristics diagrams

Reverse bias safe operating area (RBSOA), IGBT, Inverter

$I_C = f(V_{CE})$

$R_{Goff} = 3.3 \Omega$, $V_{GE} = 15 \text{ V}$, $T_{vj} = 150 \text{ }^\circ\text{C}$

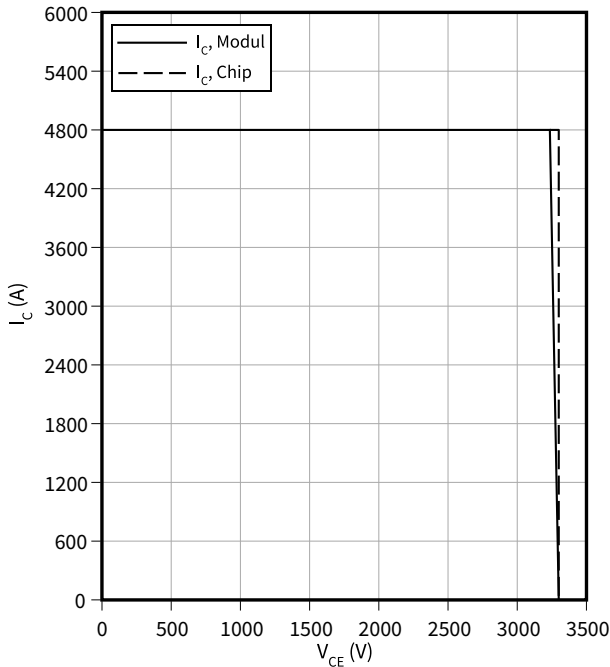

Capacity characteristic (typical), IGBT, Inverter

$C = f(V_{CE})$

$f = 100 \text{ kHz}$, $V_{GE} = 0 \text{ V}$, $T_{vj} = 25 \text{ }^\circ\text{C}$

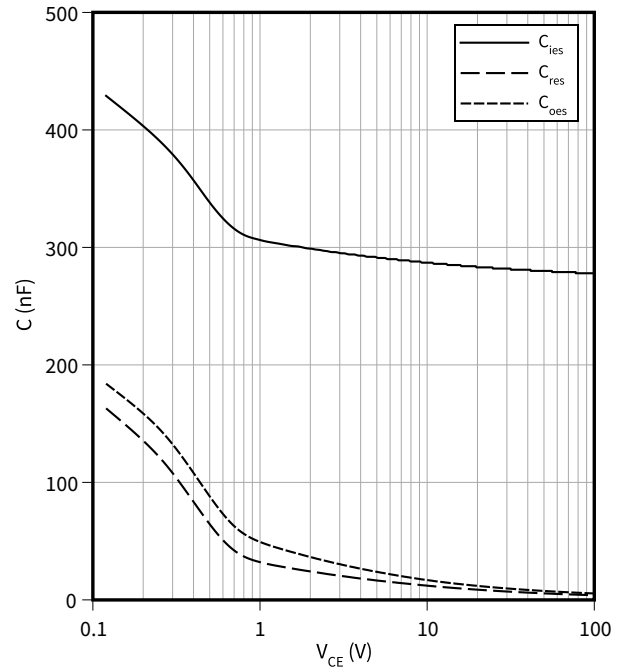

Gate charge characteristic (typical), IGBT, Inverter

$V_{GE} = f(Q_G)$

$I_C = 2400 \text{ A}$, $T_{vj} = 25 \text{ }^\circ\text{C}$

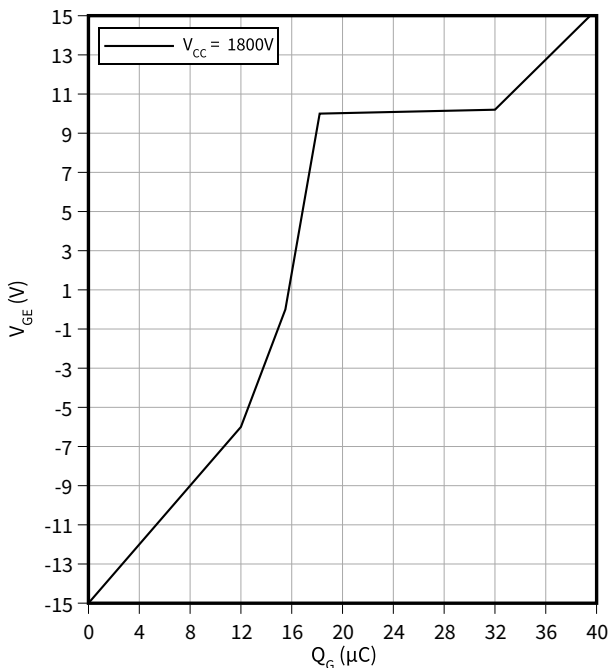

Forward characteristic (typical), Diode, Inverter

$I_F = f(V_F)$

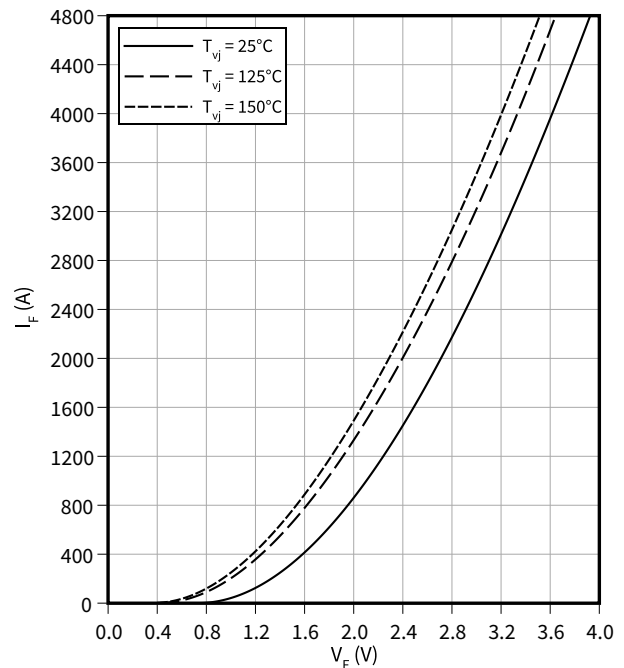

4 Characteristics diagrams

Switching losses (typical), Diode, Inverter

$E_{rec} = f(I_F)$

$V_{CE} = 1800\text{ V}$, $R_{Gon} = R_{Gon}(IGBT)$

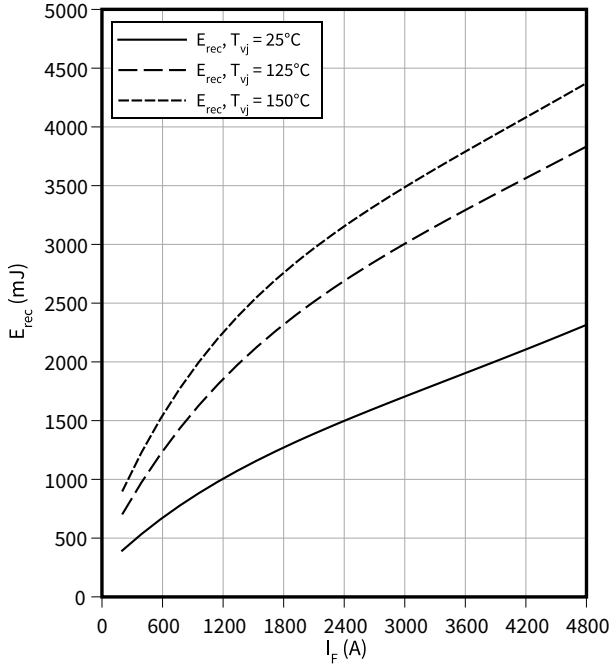

Switching losses (typical), Diode, Inverter

$E_{rec} = f(R_G)$

$V_{CE} = 1800\text{ V}$, $I_F = 2400\text{ A}$

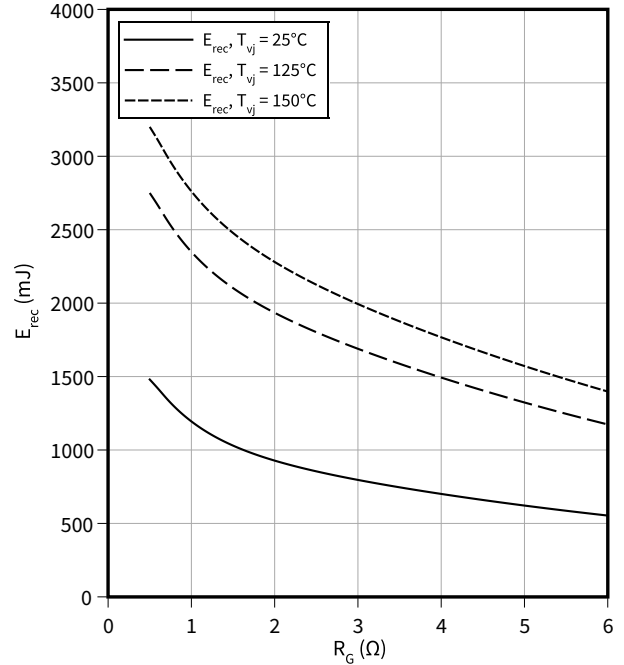

Transient thermal impedance, Diode, Inverter

$Z_{th} = f(t)$

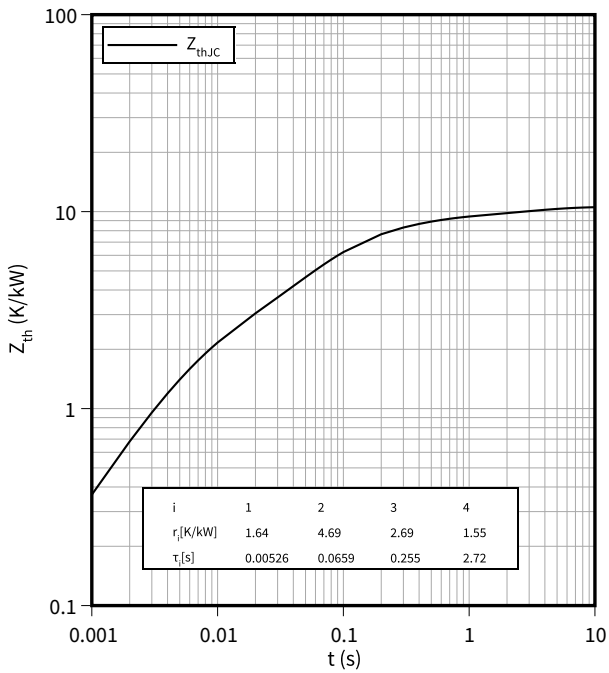

Safe operating area (SOA), Diode, Inverter

$I_R = f(V_R)$

$T_{vj} = 150\text{ °C}$

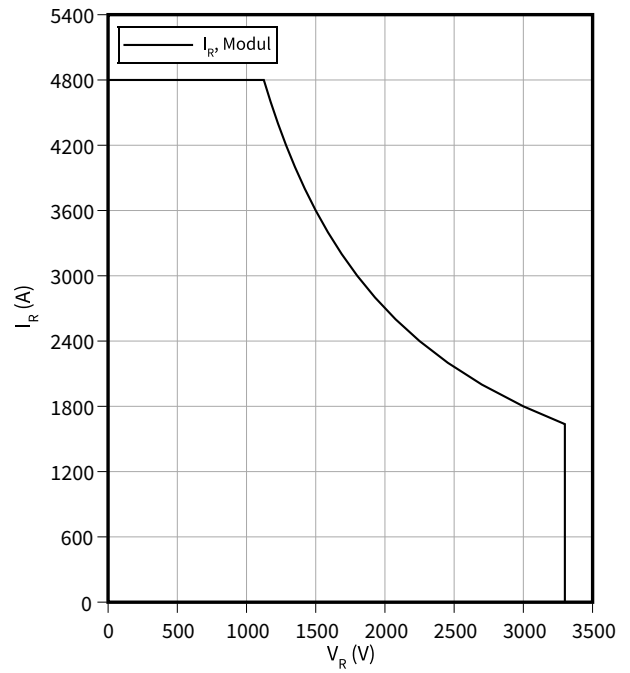

5 Circuit diagram

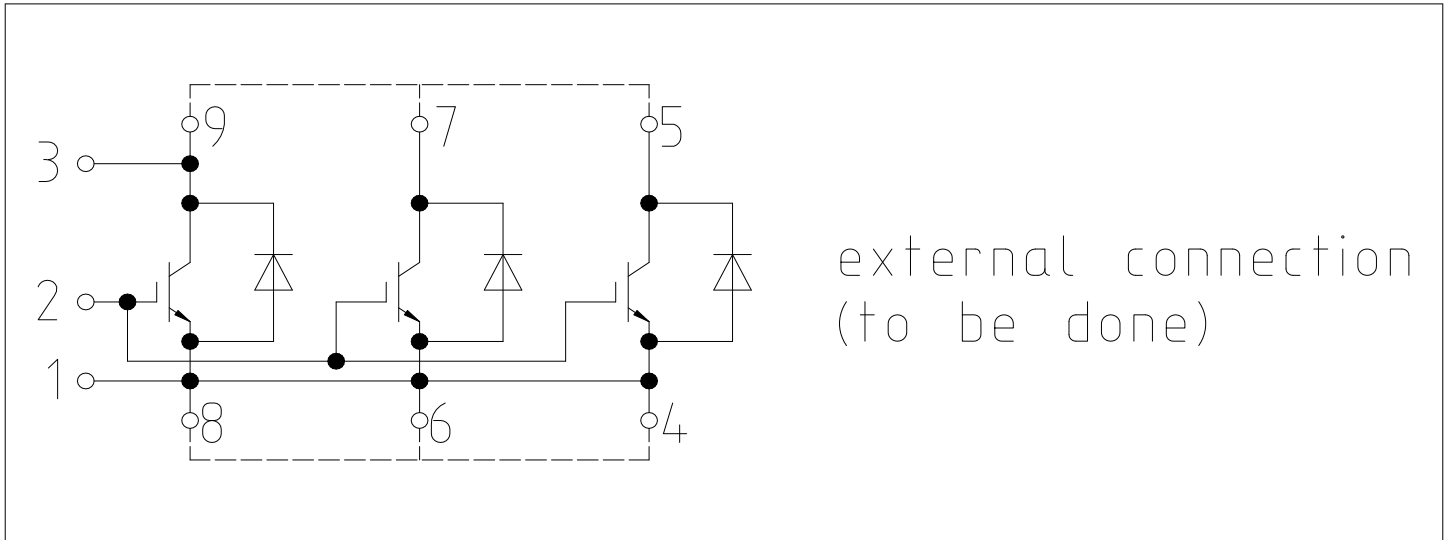

Figure 1

6 Package outlines

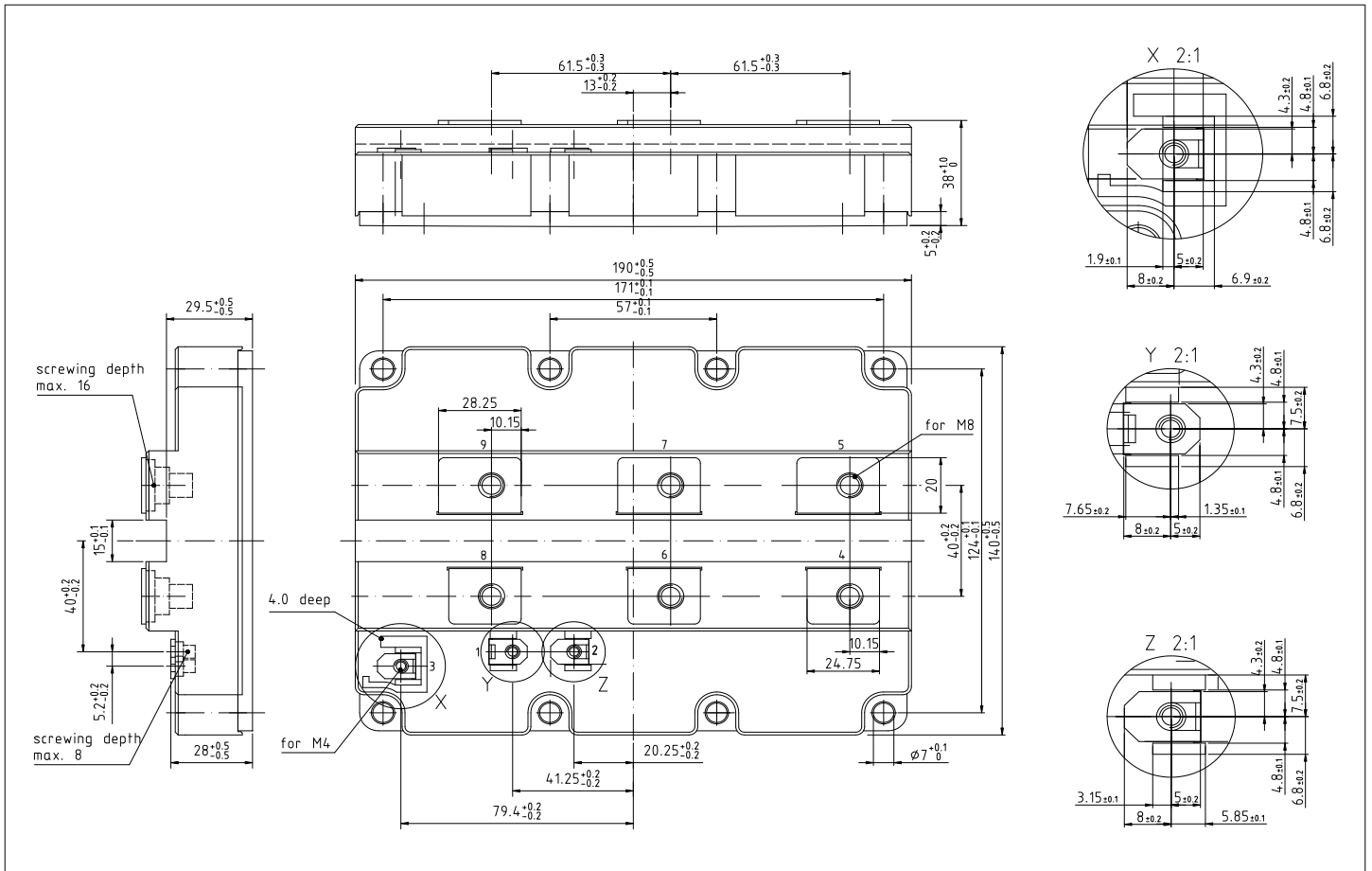

Figure 2

7 Module label code

Module label code			
Code format	Data Matrix	Barcode Code128	
Encoding	ASCII text	Code Set A	
Symbol size	16x16	23 digits	
Standard	IEC24720 and IEC16022	IEC8859-1	
Code content	<i>Content</i>	<i>Digit</i>	<i>Example</i>
	Module serial number	1 - 5	71549
	Module material number	6 - 11	142846
	Production order number	12 - 19	55054991
	Date code (production year)	20 - 21	15
	Date code (production week)	22 - 23	30
Example	 		
	71549142846550549911530		71549142846550549911530

Figure 3

Revision history

Document revision	Date of release	Description of changes
1.00	2021-03-25	
1.10	2021-10-15	Final datasheet
1.20	2022-04-27	Final datasheet
1.30	2022-11-22	Final datasheet

Trademarks

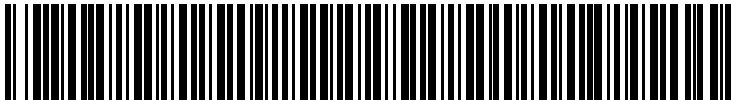
All referenced product or service names and trademarks are the property of their respective owners.

Edition 2022-11-22

Published by

Infineon Technologies AG

81726 Munich, Germany

© 2022 Infineon Technologies AG

All Rights Reserved.

Do you have a question about any aspect of this document?

Email: erratum@infineon.com

Document reference

IFX-ABA409-004

Important notice

The information given in this document shall in no event be regarded as a guarantee of conditions or characteristics ("Beschaffheitsgarantie").

With respect to any examples, hints or any typical values stated herein and/or any information regarding the application of the product, Infineon Technologies hereby disclaims any and all warranties and liabilities of any kind, including without limitation warranties of non-infringement of intellectual property rights of any third party.

In addition, any information given in this document is subject to customer's compliance with its obligations stated in this document and any applicable legal requirements, norms and standards concerning customer's products and any use of the product of Infineon Technologies in customer's applications.

The data contained in this document is exclusively intended for technically trained staff. It is the responsibility of customer's technical departments to evaluate the suitability of the product for the intended application and the completeness of the product information given in this document with respect to such application.

Please note that this product is not qualified according to the AEC Q100 or AEC Q101 documents of the Automotive Electronics Council.

Warnings

Due to technical requirements products may contain dangerous substances. For information on the types in question please contact your nearest Infineon Technologies office.

Except as otherwise explicitly approved by Infineon Technologies in a written document signed by authorized representatives of Infineon Technologies, Infineon Technologies' products may not be used in any applications where a failure of the product or any consequences of the use thereof can reasonably be expected to result in personal injury.