

PrimePACK™3+ B-series module with TRENCHSTOP™ IGBT7 and emitter controlled 7 diode and NTC / pre-applied thermal interface material

Features

- Electrical features
 - $V_{CES} = 1200\text{ V}$
 - $I_{C\text{nom}} = 2400\text{ A} / I_{CRM} = 4800\text{ A}$
 - High current density
 - Low inductive design
 - Low $V_{CE,sat}$
 - $T_{vj,op} = 150^{\circ}\text{C}$
 - Overload operation up to 175°C
- Mechanical features
 - 4 kV AC 1 min insulation
 - High creepage and clearance distances
 - High power density



Potential applications

- Motor drives

Product validation

- Qualified for industrial applications according to the relevant tests of IEC 60747, 60749 and 60068

Description

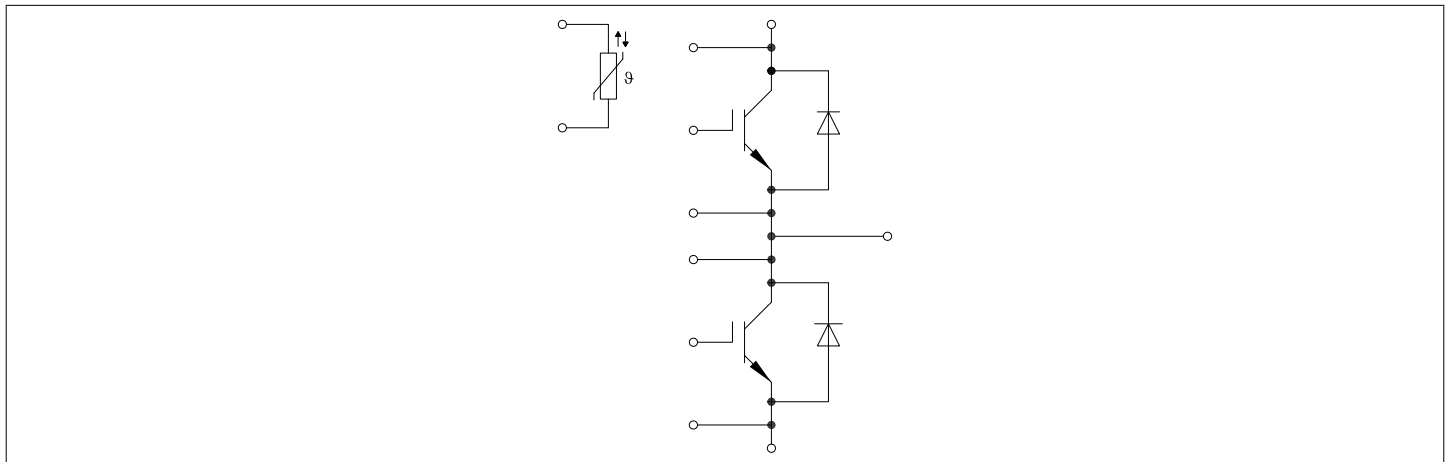

Table of contents

	Description	1
	Features	1
	Potential applications	1
	Product validation	1
	Table of contents	2
1	Package	3
2	IGBT, Inverter	3
3	Diode, Inverter	5
4	NTC-Thermistor	6
5	Characteristics diagrams	7
6	Circuit diagram	11
7	Package outlines	12
8	Module label code	13
	Revision history	14
	Disclaimer	15

1 Package

Table 1 Insulation coordination

Parameter	Symbol	Note or test condition	Values	Unit
Isolation test voltage	V_{ISOL}	RMS, $f = 50 \text{ Hz}$, $t = 60 \text{ s}$	4.0	kV
Material of module baseplate			Cu	
Internal isolation		basic insulation (class 1, IEC 61140)	Al_2O_3	
Creepage distance	d_{Creep}	terminal to heatsink	36.0	mm
Creepage distance	d_{Creep}	terminal to terminal	28.0	mm
Clearance	d_{Clear}	terminal to heatsink	21.0	mm
Clearance	d_{Clear}	terminal to terminal	19.0	mm
Comparative tracking index	CTI		> 400	

Table 2 Characteristic values

Parameter	Symbol	Note or test condition	Values			Unit	
			Min.	Typ.	Max.		
Stray inductance module	L_{SCE}			10		nH	
Module lead resistance, terminals - chip	$R_{AA'+CC'}$	$T_H = 25 \text{ °C}$, per switch		0.1		mΩ	
Module lead resistance, terminals - chip	$R_{CC'+EE'}$	$T_H = 25 \text{ °C}$, per switch		0.135		mΩ	
Current slope at AC-terminals	$ di/dt_{AC} $	Valid if AC-terminals are permanently part of commutation path			100	A/μs	
Storage temperature	T_{stg}		-40		150	°C	
Maximum baseplate operation temperature	T_{BPmax}				150	°C	
Mounting torque for module mounting	M	- Mounting according to valid application note	M5, Screw	3		6	Nm
Terminal connection torque	M	- Mounting according to valid application note	M4, Screw	1.8		2.1	Nm
			M8, Screw	8		10	
Weight	G			1400		g	

2 IGBT, Inverter

Table 3 Maximum rated values

Parameter	Symbol	Note or test condition	Values	Unit
Collector-emitter voltage	V_{CES}	$T_{Vj} = 25 \text{ °C}$	1200	V

(table continues...)

Table 3 (continued) Maximum rated values

Parameter	Symbol	Note or test condition	Values	Unit
Implemented collector current	I_{CN}		2400	A
Continuous DC collector current	I_{CDC}	$T_{vj\ max} = 175\ ^\circ\text{C}$ $T_H = 50\ ^\circ\text{C}$	2400	A
Repetitive peak collector current	I_{CRM}	t_p limited by $T_{vj\ op}$	4800	A
Gate-emitter peak voltage	V_{GES}		± 20	V

Table 4 Characteristic values

Parameter	Symbol	Note or test condition	Values			Unit
			Min.	Typ.	Max.	
Collector-emitter saturation voltage	$V_{CE\ sat}$	$I_C = 2400\ \text{A}, V_{GE} = 15\ \text{V}$	$T_{vj} = 25\ ^\circ\text{C}$	1.27	1.79	V
			$T_{vj} = 125\ ^\circ\text{C}$	1.37	1.82	
			$T_{vj} = 175\ ^\circ\text{C}$	1.43	1.85	
Gate threshold voltage	V_{GEth}	$I_C = 48\ \text{mA}, V_{CE} = V_{GE}, T_{vj} = 25\ ^\circ\text{C}$	5.15	5.80	6.45	V
Gate charge	Q_G	$V_{GE} = \pm 15\ \text{V}, V_{CC} = 600\ \text{V}$		38.1		μC
Internal gate resistor	R_{Gint}	$T_{vj} = 25\ ^\circ\text{C}$		0.33		Ω
Input capacitance	C_{ies}	$f = 100\ \text{kHz}, T_{vj} = 25\ ^\circ\text{C}, V_{CE} = 25\ \text{V}, V_{GE} = 0\ \text{V}$		325		nF
Reverse transfer capacitance	C_{res}	$f = 100\ \text{kHz}, T_{vj} = 25\ ^\circ\text{C}, V_{CE} = 25\ \text{V}, V_{GE} = 0\ \text{V}$		1.92		nF
Collector-emitter cut-off current	I_{CES}	$V_{CE} = 1200\ \text{V}, V_{GE} = 0\ \text{V}$ $T_{vj} = 25\ ^\circ\text{C}$			5	mA
Gate-emitter leakage current	I_{GES}	$V_{CE} = 0\ \text{V}, V_{GE} = 20\ \text{V}, T_{vj} = 25\ ^\circ\text{C}$			400	nA
Turn-on delay time (inductive load)	t_{don}	$I_C = 2400\ \text{A}, V_{CC} = 600\ \text{V}, V_{GE} = \pm 15\ \text{V}, R_{Gon} = 0.2\ \Omega$	$T_{vj} = 25\ ^\circ\text{C}$	0.790		μs
			$T_{vj} = 125\ ^\circ\text{C}$	0.840		
			$T_{vj} = 175\ ^\circ\text{C}$	0.870		
Rise time (inductive load)	t_r	$I_C = 2400\ \text{A}, V_{CC} = 600\ \text{V}, V_{GE} = \pm 15\ \text{V}, R_{Gon} = 0.2\ \Omega$	$T_{vj} = 25\ ^\circ\text{C}$	0.120		μs
			$T_{vj} = 125\ ^\circ\text{C}$	0.140		
			$T_{vj} = 175\ ^\circ\text{C}$	0.150		
Turn-off delay time (inductive load)	t_{doff}	$I_C = 2400\ \text{A}, V_{CC} = 600\ \text{V}, V_{GE} = \pm 15\ \text{V}, R_{Goff} = 0.4\ \Omega$	$T_{vj} = 25\ ^\circ\text{C}$	0.940		μs
			$T_{vj} = 125\ ^\circ\text{C}$	1.060		
			$T_{vj} = 175\ ^\circ\text{C}$	1.120		
Fall time (inductive load)	t_f	$I_C = 2400\ \text{A}, V_{CC} = 600\ \text{V}, V_{GE} = \pm 15\ \text{V}, R_{Goff} = 0.4\ \Omega$	$T_{vj} = 25\ ^\circ\text{C}$	0.230		μs
			$T_{vj} = 125\ ^\circ\text{C}$	0.430		
			$T_{vj} = 175\ ^\circ\text{C}$	0.530		

(table continues...)

Table 4 (continued) Characteristic values

Parameter	Symbol	Note or test condition	Values			Unit
			Min.	Typ.	Max.	
Turn-on energy loss per pulse	E_{on}	$I_C = 2400\text{ A}, V_{CC} = 600\text{ V}, L_\sigma = 20\text{ nH}, V_{GE} = \pm 15\text{ V}, R_{Gon} = 0.2\ \Omega, di/dt = 15500\text{ A}/\mu\text{s} (T_{vj} = 175\text{ }^\circ\text{C})$	$T_{vj} = 25\text{ }^\circ\text{C}$	200		mJ
			$T_{vj} = 125\text{ }^\circ\text{C}$	295		
			$T_{vj} = 175\text{ }^\circ\text{C}$	380		
Turn-off energy loss per pulse	E_{off}	$I_C = 2400\text{ A}, V_{CC} = 600\text{ V}, L_\sigma = 20\text{ nH}, V_{GE} = \pm 15\text{ V}, R_{Goff} = 0.4\ \Omega, dv/dt = 2200\text{ V}/\mu\text{s} (T_{vj} = 175\text{ }^\circ\text{C})$	$T_{vj} = 25\text{ }^\circ\text{C}$	355		mJ
			$T_{vj} = 125\text{ }^\circ\text{C}$	510		
			$T_{vj} = 175\text{ }^\circ\text{C}$	570		
SC data	I_{SC}	$V_{GE} = 15\text{ V}, V_{CC} = 800\text{ V}, V_{CEmax} = V_{CES} - L_{SCE} * di/dt$	$t_p = 6\ \mu\text{s}, T_{vj} = 150\text{ }^\circ\text{C}$	8500		A
			$t_p = 6\ \mu\text{s}, T_{vj} = 175\text{ }^\circ\text{C}$	8000		
Thermal resistance, junction to heat sink	R_{thJH}	per IGBT, Valid with IFX pre-applied Thermal Interface Material			27.6	K/kW
Temperature under switching conditions	$T_{vj\ op}$		-40		175	$^\circ\text{C}$

Note: Maximum RMS module DC-terminal current according to application note AN2009-08.

$T_{vj\ op} > 150\text{ }^\circ\text{C}$ is only allowed for operation at overload conditions. For detailed specifications please refer to AN2018-14. R_{thJH} max. value is valid for $T_C = 110\text{ }^\circ\text{C}$.

3 Diode, Inverter

Table 5 Maximum rated values

Parameter	Symbol	Note or test condition	Values	Unit	
Repetitive peak reverse voltage	V_{RRM}	$T_{vj} = 25\text{ }^\circ\text{C}$	1200	V	
Continuous DC forward current	I_F		2400	A	
Repetitive peak forward current	I_{FRM}	$t_p = 1\text{ ms}$	4800	A	
I^2t - value	I^2t	$t_p = 10\text{ ms}, V_R = 0\text{ V}$	$T_{vj} = 125\text{ }^\circ\text{C}$	455	kA^2s
			$T_{vj} = 175\text{ }^\circ\text{C}$	420	

Table 6 Characteristic values

Parameter	Symbol	Note or test condition	Values			Unit	
			Min.	Typ.	Max.		
Forward voltage	V_F	$I_F = 2400 \text{ A}, V_{GE} = 0 \text{ V}$	$T_{vj} = 25 \text{ }^\circ\text{C}$		1.70	2.03	V
			$T_{vj} = 125 \text{ }^\circ\text{C}$		1.65	1.96	
			$T_{vj} = 175 \text{ }^\circ\text{C}$		1.55	1.91	
Peak reverse recovery current	I_{RM}	$V_{CC} = 600 \text{ V}, I_F = 2400 \text{ A}, V_{GE} = -15 \text{ V}, -di_F/dt = 15500 \text{ A}/\mu\text{s} (T_{vj} = 175 \text{ }^\circ\text{C})$	$T_{vj} = 25 \text{ }^\circ\text{C}$		1410		A
			$T_{vj} = 125 \text{ }^\circ\text{C}$		1720		
			$T_{vj} = 175 \text{ }^\circ\text{C}$		1850		
Recovered charge	Q_r	$V_{CC} = 600 \text{ V}, I_F = 2400 \text{ A}, V_{GE} = -15 \text{ V}, -di_F/dt = 15500 \text{ A}/\mu\text{s} (T_{vj} = 175 \text{ }^\circ\text{C})$	$T_{vj} = 25 \text{ }^\circ\text{C}$		265		μC
			$T_{vj} = 125 \text{ }^\circ\text{C}$		455		
			$T_{vj} = 175 \text{ }^\circ\text{C}$		585		
Reverse recovery energy	E_{rec}	$V_{CC} = 600 \text{ V}, I_F = 2400 \text{ A}, V_{GE} = -15 \text{ V}, -di_F/dt = 15500 \text{ A}/\mu\text{s} (T_{vj} = 175 \text{ }^\circ\text{C})$	$T_{vj} = 25 \text{ }^\circ\text{C}$		110		mJ
			$T_{vj} = 125 \text{ }^\circ\text{C}$		200		
			$T_{vj} = 175 \text{ }^\circ\text{C}$		250		
Thermal resistance, junction to heat sink	R_{thJH}	per diode, Valid with IFX pre-applied Thermal Interface Material				46.4	K/kW
Temperature under switching conditions	$T_{vj\text{ op}}$		-40			175	$^\circ\text{C}$

Note: $T_{vj\text{ op}} > 150 \text{ }^\circ\text{C}$ is only allowed for operation at overload conditions. For detailed specifications please refer to AN2018-14. R_{thJH} max. value is valid for $T_C = 95 \text{ }^\circ\text{C}$.

4 NTC-Thermistor

Table 7 Characteristic values

Parameter	Symbol	Note or test condition	Values			Unit
			Min.	Typ.	Max.	
Rated resistance	R_{25}	$T_{NTC} = 25 \text{ }^\circ\text{C}$		5		k Ω
Deviation of R_{100}	$\Delta R/R$	$T_{NTC} = 100 \text{ }^\circ\text{C}, R_{100} = 493 \text{ } \Omega$	-5		5	%
Power dissipation	P_{25}	$T_{NTC} = 25 \text{ }^\circ\text{C}$			20	mW
B-value	$B_{25/50}$	$R_2 = R_{25} \exp[B_{25/50}(1/T_2 - 1/(298,15 \text{ K}))]$		3375		K
B-value	$B_{25/80}$	$R_2 = R_{25} \exp[B_{25/80}(1/T_2 - 1/(298,15 \text{ K}))]$		3411		K
B-value	$B_{25/100}$	$R_2 = R_{25} \exp[B_{25/100}(1/T_2 - 1/(298,15 \text{ K}))]$		3433		K

Note: For an analytical description of the NTC characteristics please refer to AN2009-10, chapter 4

5 Characteristics diagrams

Output characteristic (typical), IGBT, Inverter

$$I_C = f(V_{CE})$$

$$V_{GE} = 15 \text{ V}$$

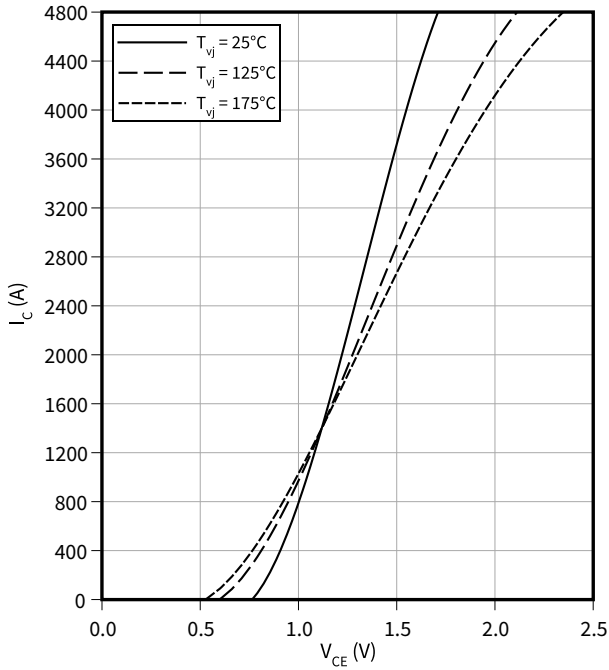

Output characteristic field (typical), IGBT, Inverter

$$I_C = f(V_{CE})$$

$$T_{vj} = 175 \text{ °C}$$

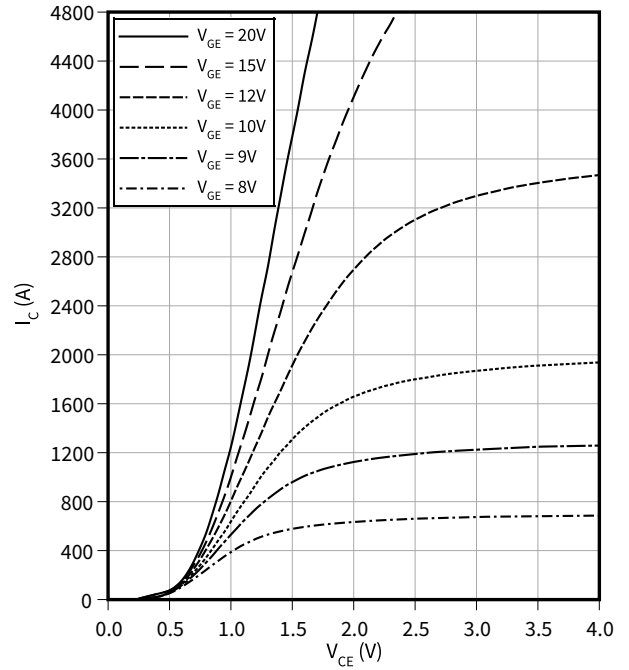

Transfer characteristic (typical), IGBT, Inverter

$$I_C = f(V_{GE})$$

$$V_{CE} = 20 \text{ V}$$

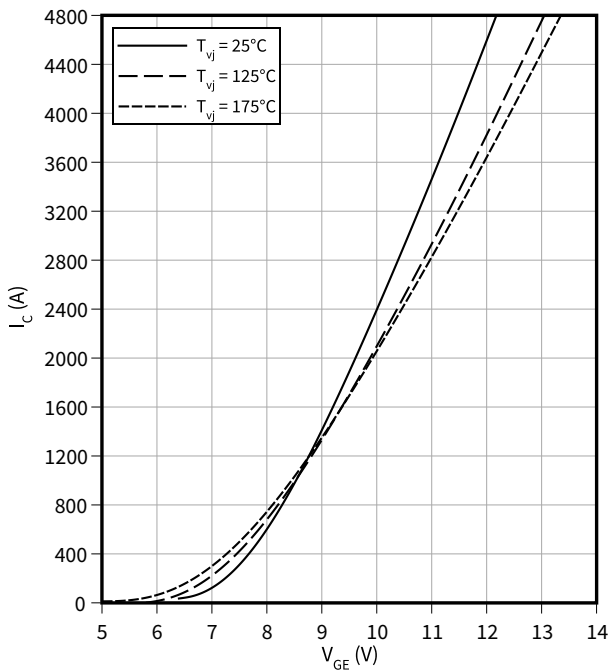

Gate charge characteristic (typical), IGBT, Inverter

$$V_{GE} = f(Q_G)$$

$$I_C = 2400 \text{ A}, T_{vj} = 25 \text{ °C}$$

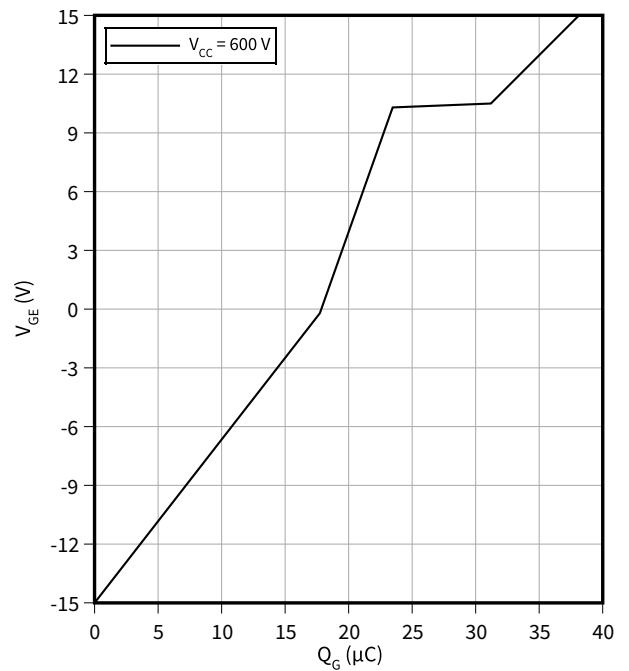

5 Characteristics diagrams

Capacity characteristic (typical), IGBT, Inverter

$C = f(V_{CE})$
 $f = 100 \text{ kHz}, V_{GE} = 0 \text{ V}, T_{vj} = 25 \text{ }^\circ\text{C}$

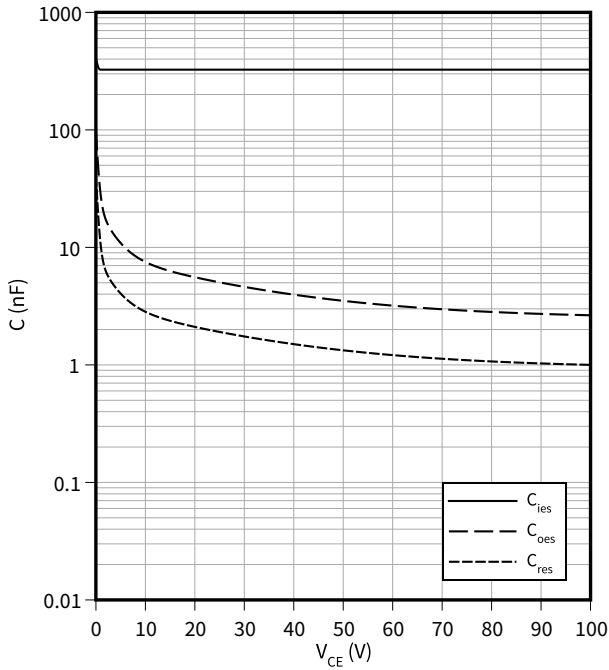

Switching times (typical), IGBT, Inverter

$t = f(I_C)$
 $R_{Goff} = 0.4 \text{ } \Omega, R_{Gon} = 0.2 \text{ } \Omega, V_{CC} = 600 \text{ V}, V_{GE} = \pm 15 \text{ V}, T_{vj} = 175 \text{ }^\circ\text{C}$

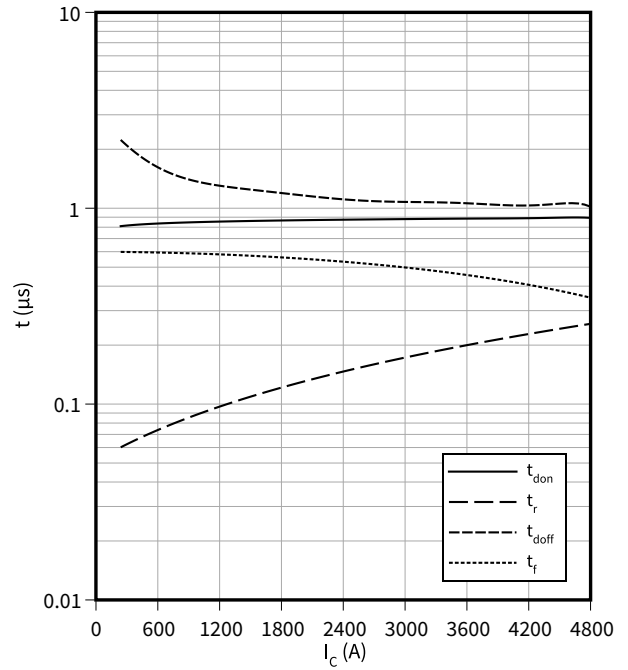

Switching times (typical), IGBT, Inverter

$t = f(R_G)$
 $I_C = 2400 \text{ A}, V_{CC} = 600 \text{ V}, V_{GE} = \pm 15 \text{ V}, T_{vj} = 175 \text{ }^\circ\text{C}$

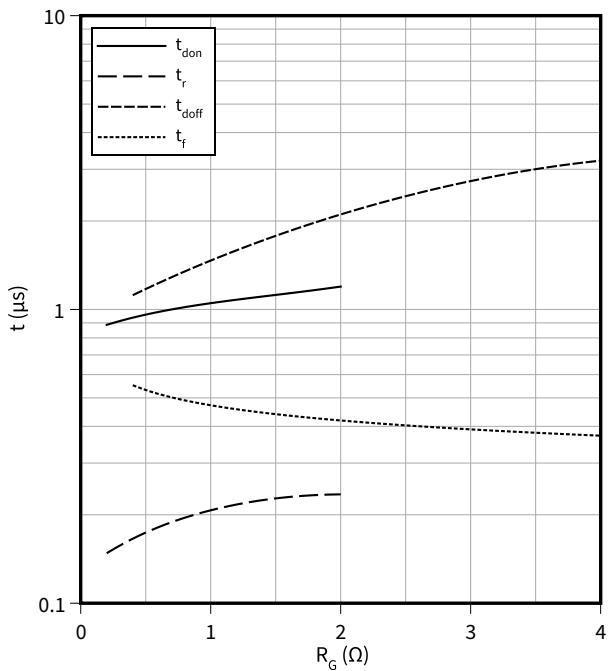

Switching losses (typical), IGBT, Inverter

$E = f(I_C)$
 $R_{Goff} = 0.4 \text{ } \Omega, R_{Gon} = 0.2 \text{ } \Omega, V_{CC} = 600 \text{ V}, V_{GE} = \pm 15 \text{ V}$

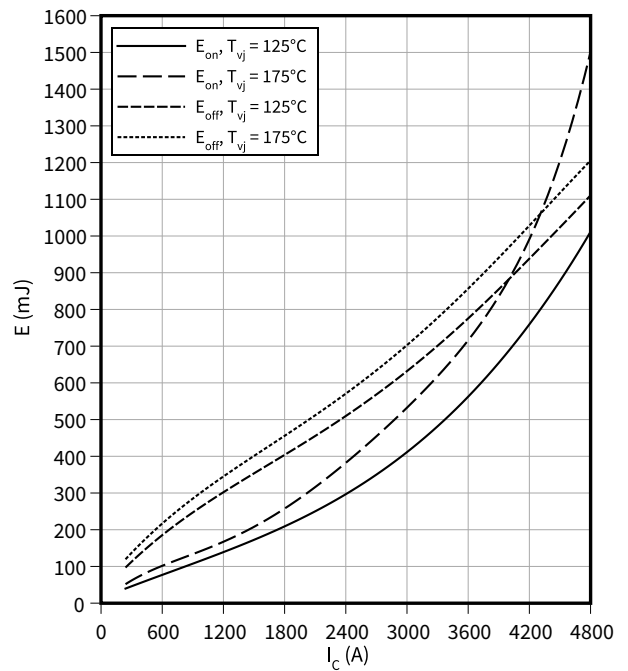

5 Characteristics diagrams

Switching losses (typical), IGBT, Inverter

$E = f(R_G)$

$I_C = 2400 \text{ A}$, $V_{CC} = 600 \text{ V}$, $V_{GE} = \pm 15 \text{ V}$

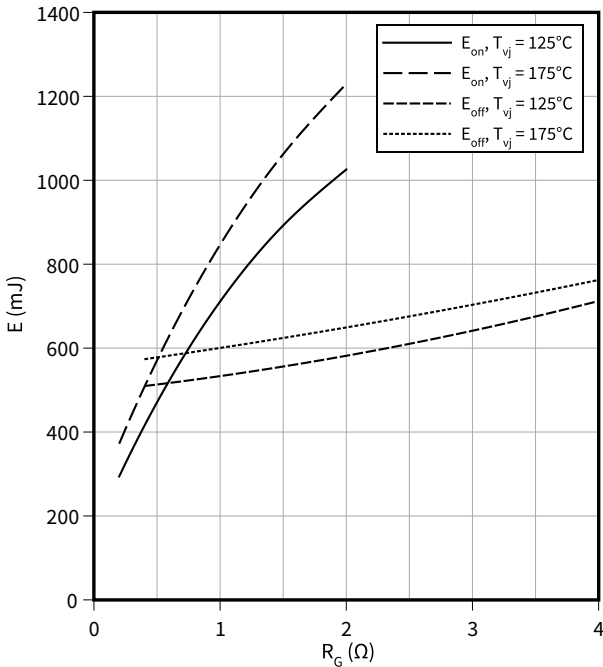

Reverse bias safe operating area (RBSOA), IGBT, Inverter

$I_C = f(V_{CE})$

$R_{Goff} = 0.4 \Omega$, $V_{GE} = 15 \text{ V}$, $T_{vj} = 175 \text{ °C}$

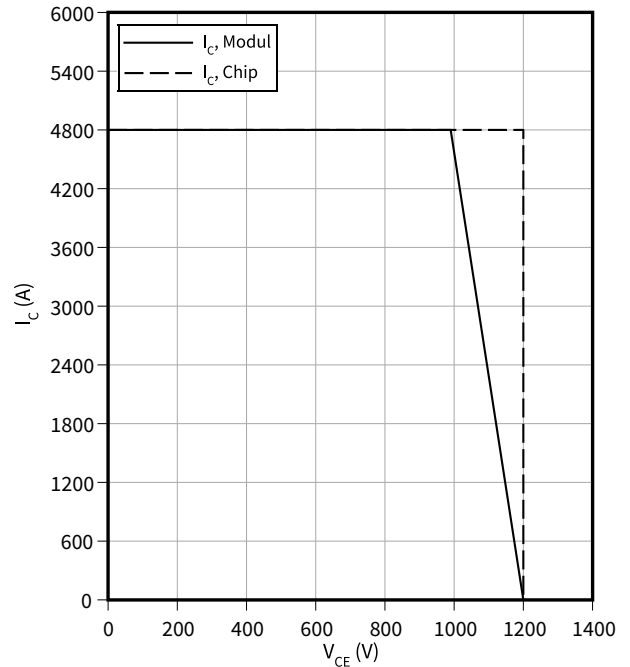

Transient thermal impedance, IGBT, Inverter

$Z_{th} = f(t)$

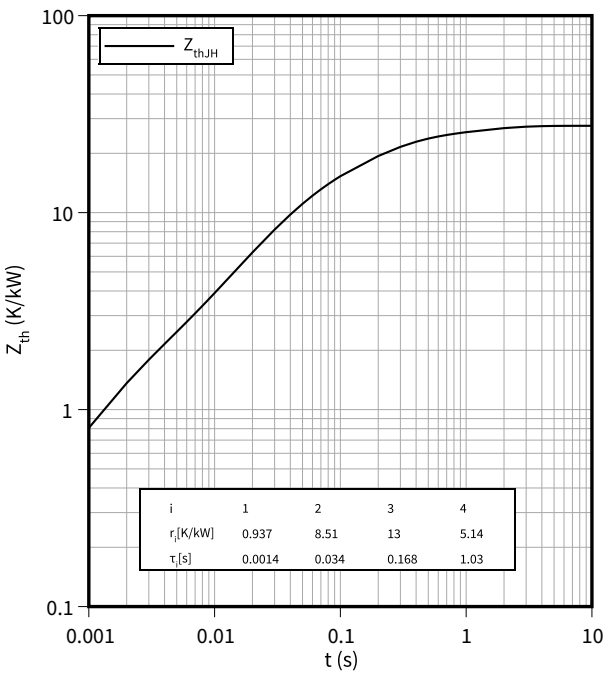

Forward characteristic (typical), Diode, Inverter

$I_F = f(V_F)$

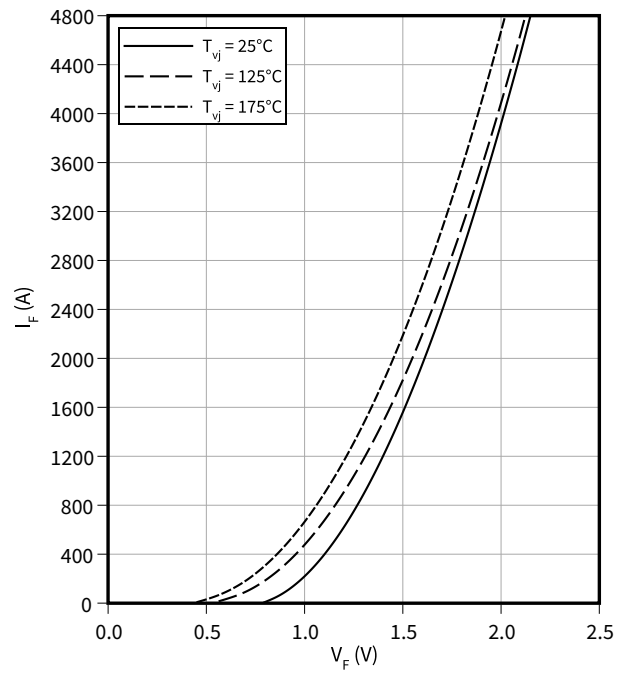

5 Characteristics diagrams

Switching losses (typical), Diode, Inverter

$E_{rec} = f(I_F)$
 $V_{CE} = 600\text{ V}, R_{Gon} = R_{Gon}(IGBT)$

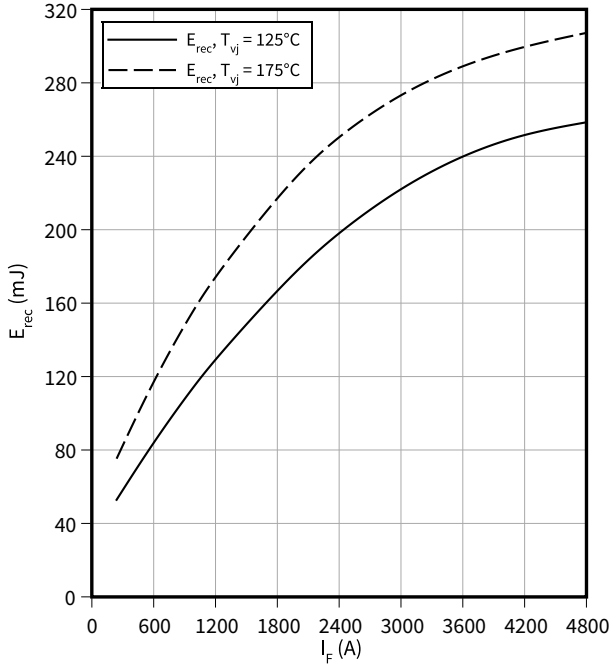

Switching losses (typical), Diode, Inverter

$E_{rec} = f(R_G)$
 $V_{CE} = 600\text{ V}, I_F = 2400\text{ A}$

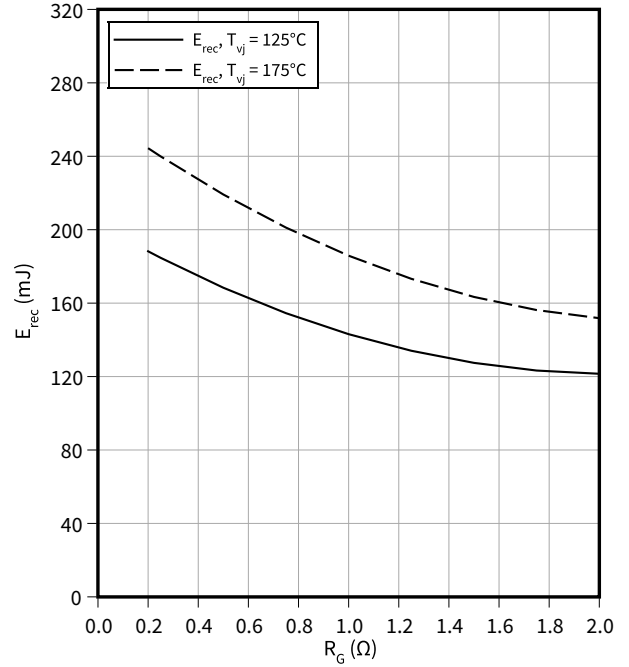

Transient thermal impedance, Diode, Inverter

$Z_{th} = f(t)$

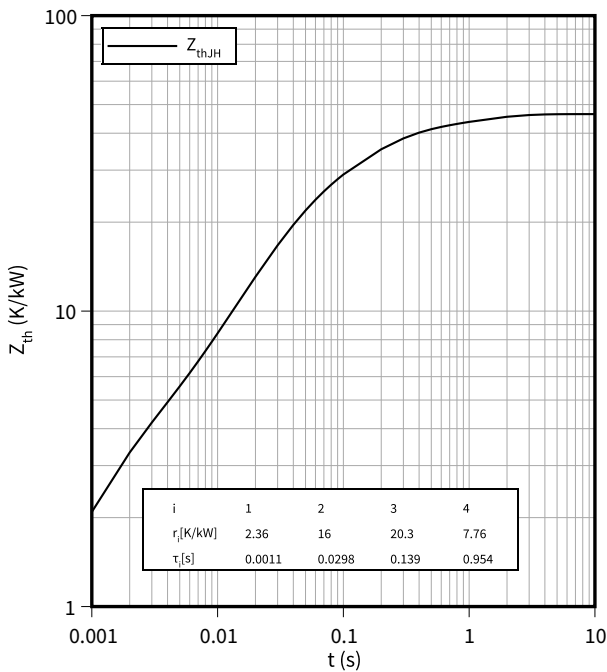

Temperature characteristic (typical), NTC-Thermistor

$R = f(T_{NTC})$

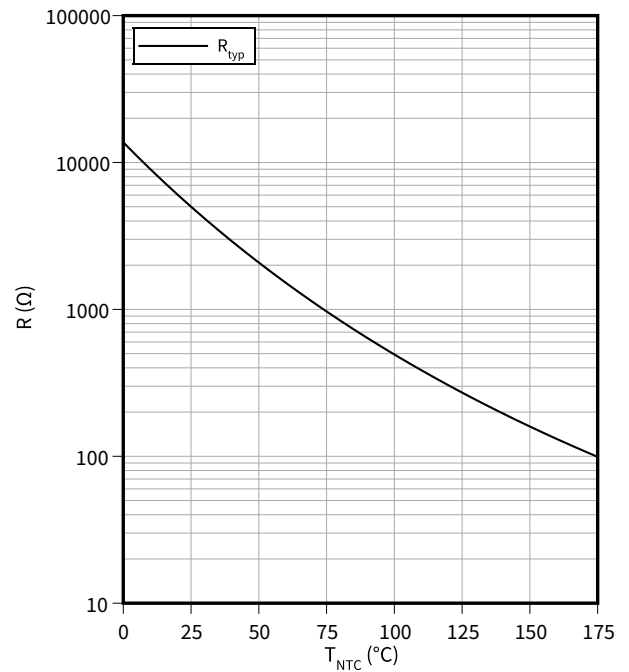

6 Circuit diagram

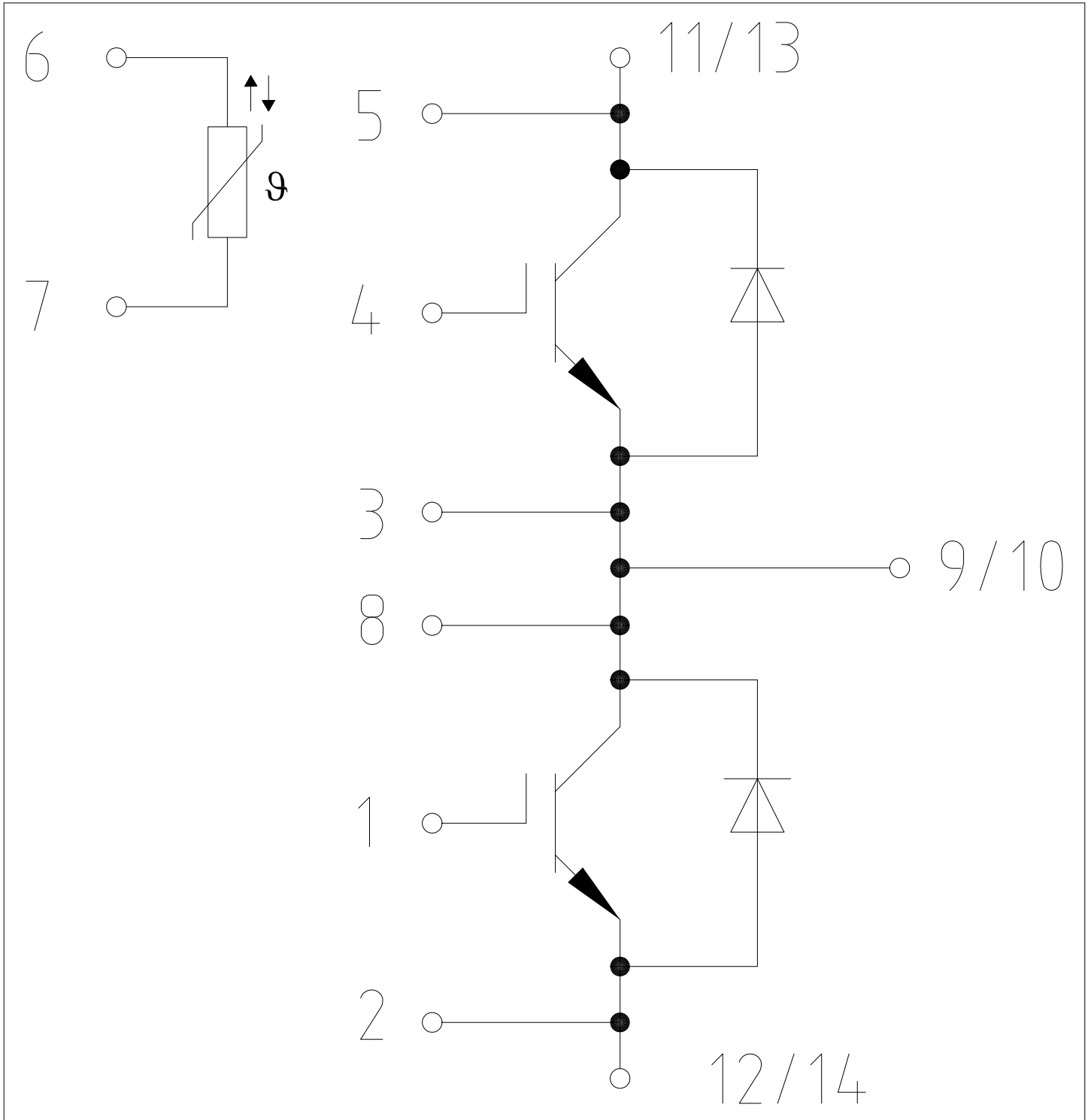

Figure 1

7 Package outlines

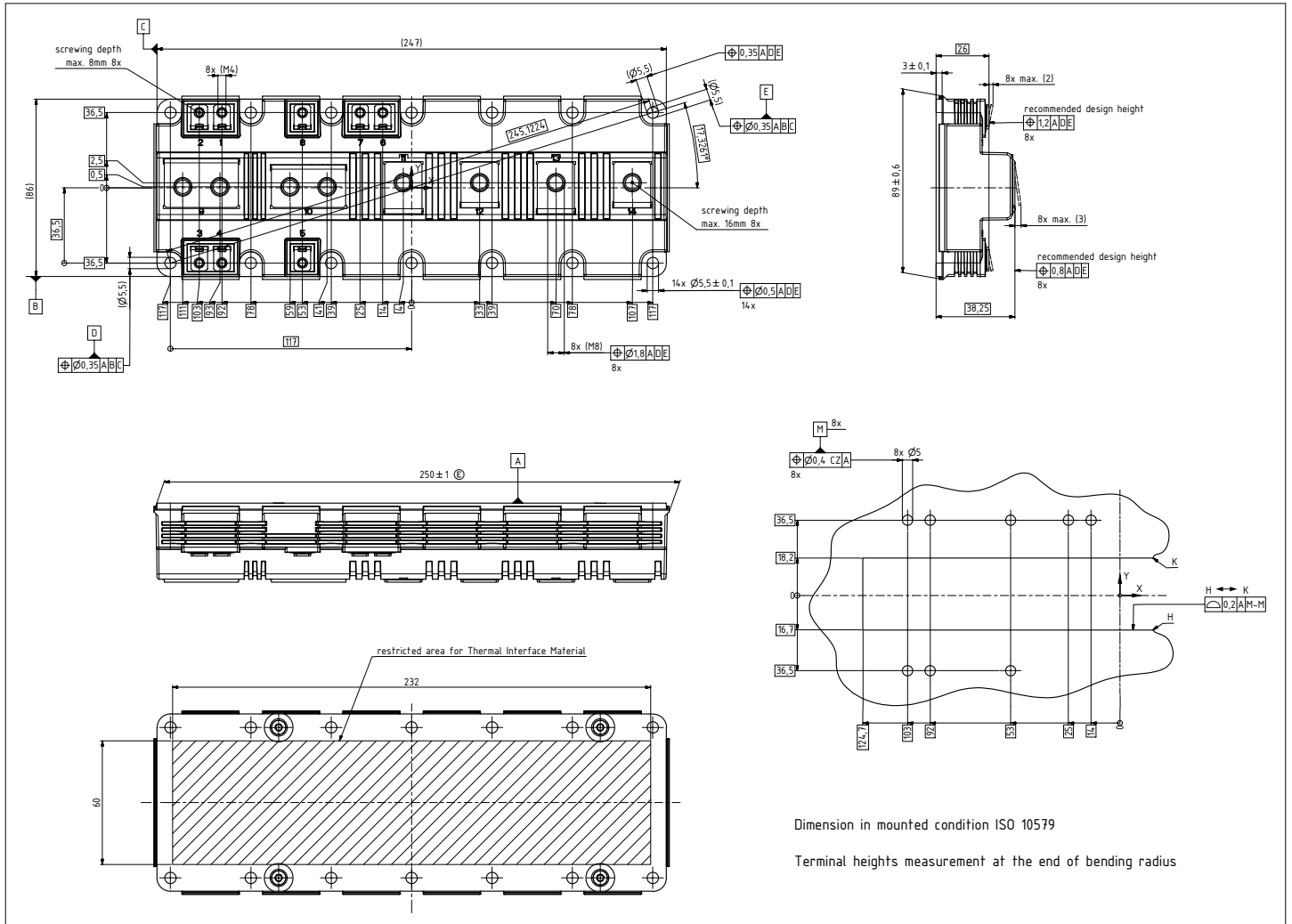

Figure 2

8 Module label code

Module label code			
Code format	Data Matrix	Barcode Code128	
Encoding	ASCII text	Code Set A	
Symbol size	16x16	23 digits	
Standard	IEC24720 and IEC16022	IEC8859-1	
Code content	<i>Content</i>	<i>Digit</i>	<i>Example</i>
	Module serial number	1 - 5	71549
	Module material number	6 - 11	142846
	Production order number	12 - 19	55054991
	Date code (production year)	20 - 21	15
	Date code (production week)	22 - 23	30
Example	 		
	71549142846550549911530		71549142846550549911530

Figure 3

Revision history

Document revision	Date of release	Description of changes
1.00	2023-06-09	Initial version

Trademarks

All referenced product or service names and trademarks are the property of their respective owners.

Edition 2023-06-09

Published by

Infineon Technologies AG

81726 Munich, Germany

© 2023 Infineon Technologies AG

All Rights Reserved.

Do you have a question about any aspect of this document?

Email: erratum@infineon.com

Document reference

IFX-AAD907-001

Important notice

The information given in this document shall in no event be regarded as a guarantee of conditions or characteristics ("Beschaffheitsgarantie").

With respect to any examples, hints or any typical values stated herein and/or any information regarding the application of the product, Infineon Technologies hereby disclaims any and all warranties and liabilities of any kind, including without limitation warranties of non-infringement of intellectual property rights of any third party.

In addition, any information given in this document is subject to customer's compliance with its obligations stated in this document and any applicable legal requirements, norms and standards concerning customer's products and any use of the product of Infineon Technologies in customer's applications.

The data contained in this document is exclusively intended for technically trained staff. It is the responsibility of customer's technical departments to evaluate the suitability of the product for the intended application and the completeness of the product information given in this document with respect to such application.

Please note that this product is not qualified according to the AEC Q100 or AEC Q101 documents of the Automotive Electronics Council.

Warnings

Due to technical requirements products may contain dangerous substances. For information on the types in question please contact your nearest Infineon Technologies office.

Except as otherwise explicitly approved by Infineon Technologies in a written document signed by authorized representatives of Infineon Technologies, Infineon Technologies' products may not be used in any applications where a failure of the product or any consequences of the use thereof can reasonably be expected to result in personal injury.