



## Standard Recovery Diodes (MAGN-A-PAK Power Modules), 250 A to 320 A



MAGN-A-PAK

### FEATURES

- High voltage
- Electrically isolated base plate
- 3000 V<sub>RMS</sub> isolating voltage
- Industrial standard package
- Simplified mechanical designs, rapid assembly
- High surge capability
- Large creepage distances
- UL approved file E78996 
- Designed and qualified for industrial level
- Material categorization: for definitions of compliance please see [www.vishay.com/doc?99912](http://www.vishay.com/doc?99912)



RoHS  
COMPLIANT

| PRIMARY CHARACTERISTICS |   |
|-------------------------|---|
| I <sub>F(AV)</sub>      | 250 A to 320 A  |
| Type                    | Modules - diode, high voltage                                       |
| Package                 | MAGN-A-PAK  |
| Circuit configuration   | Two diodes doubler circuit, two diodes common cathode, single diode |

### DESCRIPTION / APPLICATIONS

This VS-VSK series of MAGN-A-PAKs uses high voltage power diodes in two basic configurations. The semiconductors are electrically isolated from the metal base, allowing common heatsinks and compact assemblies to be built. They can be interconnected to form single phase or three phase bridges and the single diode module can be used in conjunction with the thyristor modules as a freewheel diode.

These modules are intended for general purpose applications such as battery chargers, welders and plating equipment and where high voltage and high current are required (motor drives, etc.)

| MAJOR RATINGS AND CHARACTERISTICS |                 |             |             |             |                    |
|-----------------------------------|-----------------|-------------|-------------|-------------|--------------------|
| SYMBOL                            | CHARACTERISTICS | VSK.250..   | VSK.270..   | VSK.320..   | UNITS              |
| I <sub>F(AV)</sub>                |                 | 250         | 270         | 320         | A                  |
|                                   | T <sub>C</sub>  | 100         | 100         | 100         | °C                 |
| I <sub>F(RMS)</sub>               |                 | 393         | 424         | 502         | A                  |
| I <sub>FSM</sub>                  | 50 Hz           | 7015        | 8920        | 10 110      |                    |
|                                   | 60 Hz           | 7345        | 9430        | 10 580      |                    |
| I <sup>2</sup> t                  | 50 Hz           | 246         | 398         | 511         | kA <sup>2</sup> s  |
|                                   | 60 Hz           | 225         | 363         | 466         |                    |
| I <sup>2</sup> √t                 |                 | 2460        | 3980        | 5110        | kA <sup>2</sup> √s |
| V <sub>RRM</sub>                  |                 | 400 to 2000 | 400 to 3000 | 400 to 2000 | V                  |
| T <sub>J</sub>                    |                 | -40 to +150 |             |             | °C                 |



**ELECTRICAL SPECIFICATIONS**

| <b>VOLTAGE RATINGS</b>                 |              |   |   |  |
|--|--------------|---|---|--|
| TYPE NUMBER                            | VOLTAGE CODE | V <sub>RRM</sub> , MAXIMUM REPETITIVE PEAK REVERSE VOLTAGE<br>V | V <sub>RSM</sub> , MAXIMUM NON-REPETITIVE PEAK REVERSE VOLTAGE<br>V | I <sub>RRM</sub> MAXIMUM AT 150 °C<br>mA |
| VS-VSK.270<br>VS-VSK.320               | 04           | 400   | 500   | 50                                       |
| VS-VSK.250<br>VS-VSK.270<br>VS-VSK.320 | 08           | 800   | 900   |  |
|  | 12           | 1200  | 1300  |  |
|  | 16           | 1600  | 1700  |  |
|  | 20           | 2000  | 2100  |  |
| VS-VSK.270                             | 30           | 3000  | 3100  |  |

| <b>FORWARD CONDUCTION</b>                                     |                     |   |                                   |  |         |         |         |                    |
|---|---------------------|---|-----------------------------------|--|---------|---------|---------|--------------------|
| PARAMETER   | SYMBOL              | TEST CONDITIONS   |                                   |  | VALUES  |         |         | UNITS              |
|   |                     |   |                                   |  | VSK.250 | VSK.270 | VSK.320 |                    |
| Maximum average forward current at case temperature           | I <sub>F(AV)</sub>  | 180° conduction, half sine wave   |                                   |  | 250     | 270     | 320     | A                  |
|   |                     |   |                                   |  | 100     | 100     | 100     | °C                 |
| Maximum RMS forward current                                   | I <sub>F(RMS)</sub> | As AC switch  |                                   |  | 393     | 424     | 502     | A                  |
| Maximum peak, one-cycle forward, non-repetitive surge current | I <sub>FSM</sub>    | t = 10 ms   | No voltage reappplied             | Sinusoidal half wave, initial<br>T <sub>J</sub> = T <sub>J</sub> maximum | 7015    | 8920    | 10 110  |                    |
|   |                     | t = 8.3 ms  |                                   |  | 7345    | 9340    | 10 580  |                    |
|   |                     | t = 10 ms   | 100 % V <sub>RRM</sub> reappplied |  | 5900    | 7500    | 8500    |                    |
|   |                     | t = 8.3 ms  |                                   |  | 6180    | 7850    | 8900    |                    |
| Maximum I <sup>2</sup> t for fusing                           | I <sup>2</sup> t    | t = 10 ms   | No voltage reappplied             |  | 246     | 398     | 511     |                    |
|   |                     | t = 8.3 ms  |                                   |  | 225     | 363     | 466     |                    |
|   |                     | t = 10 ms   | 100 % V <sub>RRM</sub> reappplied | 174  | 281     | 361     |         |                    |
|   |                     | t = 8.3 ms  |                                   | 159  | 257     | 330     |         |                    |
| Maximum I <sup>2</sup> √t for fusing                          | I <sup>2</sup> √t   | t = 0.1 ms to 10 ms, no voltage reappplied  |                                   |  | 2460    | 3980    | 5110    | kA <sup>2</sup> √s |
| Low level value of threshold voltage                          | V <sub>F(TO)1</sub> | (16.7 % × π × I <sub>F(AV)</sub> ) < I < π × I <sub>F(AV)</sub> , T <sub>J</sub> = T <sub>J</sub> maximum   |                                   |  | 0.79    | 0.74    | 0.69    | V                  |
| High level value of threshold voltage                         | V <sub>F(TO)2</sub> | I > π × I <sub>F(AV)</sub> , T <sub>J</sub> = T <sub>J</sub> maximum  |                                   |  | 0.92    | 0.87    | 0.86    |                    |
| Low level forward slope resistance                            | r <sub>f1</sub>     | (16.7 % × π × I <sub>F(AV)</sub> ) < I < π × I <sub>F(AV)</sub> , T <sub>J</sub> = T <sub>J</sub> maximum   |                                   |  | 0.63    | 0.94    | 0.59    | mΩ                 |
| High level forward slope resistance                           | r <sub>f2</sub>     | I > π × I <sub>F(AV)</sub> , T <sub>J</sub> = T <sub>J</sub> maximum  |                                   |  | 0.49    | 0.81    | 0.44    |                    |
| Maximum forward voltage drop                                  | V <sub>FM</sub>     | I <sub>FM</sub> = π × I <sub>F(AV)</sub> , T <sub>J</sub> = T <sub>J</sub> maximum, 180° conduction<br>Average power = V <sub>F(TO)</sub> × I <sub>F(AV)</sub> + r <sub>f</sub> × (I <sub>F(RMS)</sub> ) <sup>2</sup> |                                   |  | 1.29    | 1.48    | 1.28    | V                  |

| <b>BLOCKING</b>                      |                  |  |        |       |
|--------------------------------------|------------------|--|--------|-------|
| PARAMETER                            | SYMBOL           | TEST CONDITIONS  | VALUES | UNITS |
| Maximum peak reverse leakage current | I <sub>RRM</sub> | T <sub>J</sub> = 150 °C                                | 50     | mA    |
| RMS insulation voltage               | V <sub>INS</sub> | 50 Hz, circuit to base, all terminals shorted, t = 1 s | 3000   | V     |



| THERMAL AND MECHANICAL SPECIFICATIONS                     |  |  |             |         |         |       |
|---|--|--|-------------|---------|---------|-------|
| PARAMETER   | SYMBOL   | TEST CONDITIONS  | VALUES      |         |         | UNITS |
|   |  |  | VSK.250     | VSK.270 | VSK.320 |       |
| Maximum junction operating and storage temperature range  | $T_J, T_{Stg}$                                 |  | -40 to +150 |         |         | °C    |
| Maximum thermal resistance, junction to case per junction | $R_{thJC}$                                     | DC operation   | 0.16        | 0.125   | 0.125   | K/W   |
| Maximum resistance, case to heat sink per module          | $R_{thCS}$                                     | Mounting surface flat, smooth and greased  | 0.035       |         |         |       |
| Mounting torque $\pm 10\%$                                | MAGN-A-PAK to heatsink<br>Busbar to MAGN-A-PAK | A mounting compound is recommended and the torque should be rechecked after a period of about 3 hours to allow for the spread of the compound. | 4 to 6      |         |         | Nm    |
| Approximate weight  |  |  | 800         |         |         | g     |
|   |  |  | 30          |         |         | oz.   |
| Case style  |  |  | MAGN-A-PAK  |         |         |       |

| ΔR CONDUCTION PER JUNCTION |  |       |       |       |       |   |       |       |       |       |       |
|----------------------------|--|-------|-------|-------|-------|---|-------|-------|-------|-------|-------|
| DEVICE                     | SINUSOIDAL CONDUCTION AT $T_J$ MAXIMUM |       |       |       |       | RECTANGULAR CONDUCTION AT $T_J$ MAXIMUM |       |       |       |       | UNITS |
|                            | 180°                                   | 120°  | 90°   | 60°   | 30°   | 180°                                    | 120°  | 90°   | 60°   | 30°   |       |
| VSK.250                    | 0.009                                  | 0.010 | 0.014 | 0.020 | 0.032 | 0.007                                   | 0.011 | 0.015 | 0.021 | 0.033 | K/W   |
| VSK.270                    | 0.008                                  | 0.012 | 0.014 | 0.020 | 0.032 | 0.007                                   | 0.011 | 0.015 | 0.020 | 0.033 |       |
| VSK.320                    | 0.008                                  | 0.010 | 0.013 | 0.020 | 0.032 | 0.007                                   | 0.011 | 0.015 | 0.020 | 0.033 |       |

**Note**

- The table above shows the increment of thermal resistance  $R_{thJC}$  when devices operate at different conduction angles than DC



# VS-VSK.250PbF, VS-VSK.270PbF, VS-VSK.320PbF Series

[www.vishay.com](http://www.vishay.com)

Vishay Semiconductors

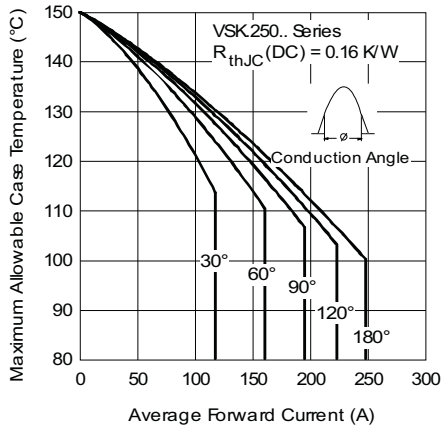

Fig. 1 - Current Ratings Characteristics

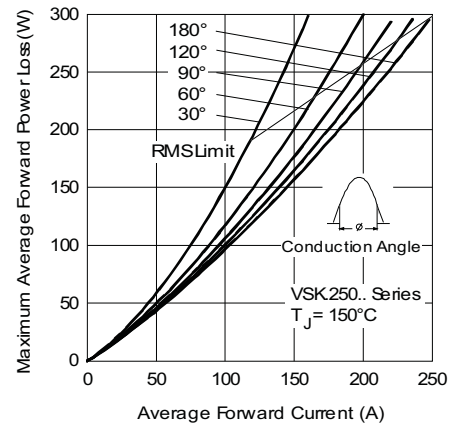

Fig. 3 - Forward Power Loss Characteristics

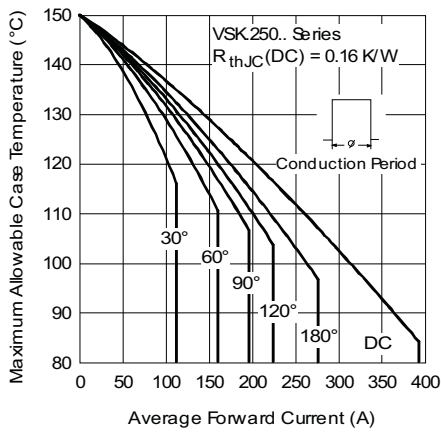

Fig. 2 - Current Ratings Characteristics

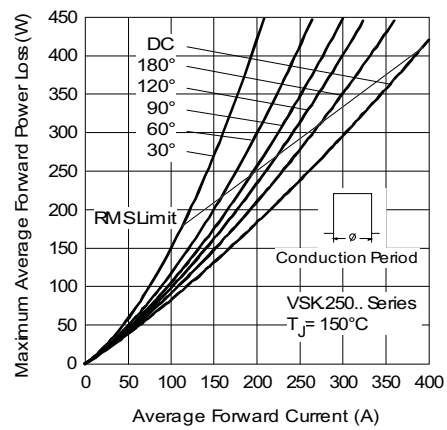

Fig. 4 - Forward Power Loss Characteristics

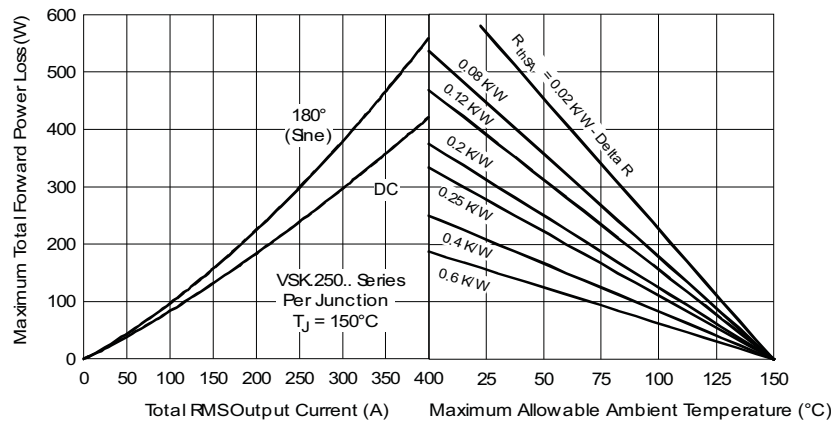

Fig. 5 - Forward Power Loss Characteristics

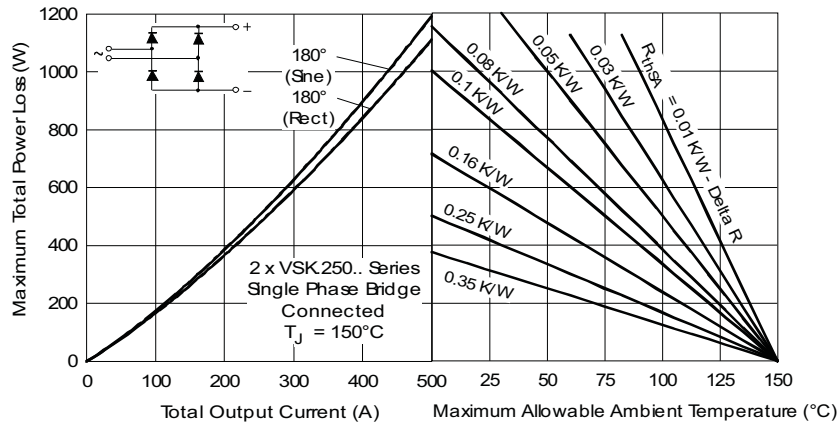

Fig. 6 - Forward Power Loss Characteristics

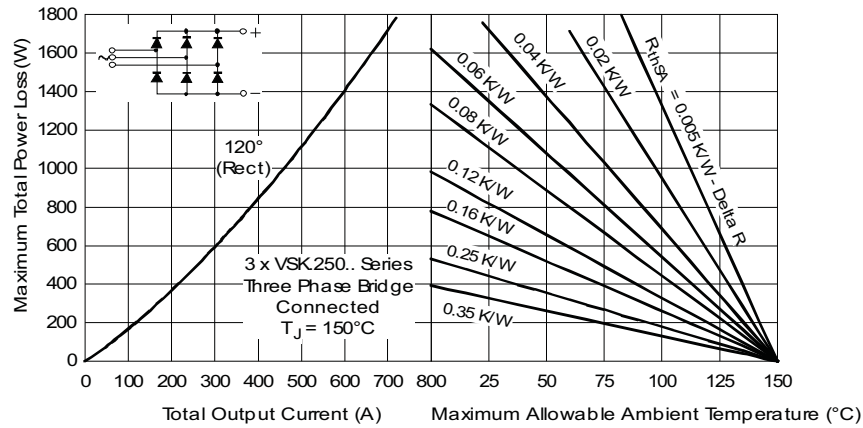

Fig. 7 - Forward Power Loss Characteristics

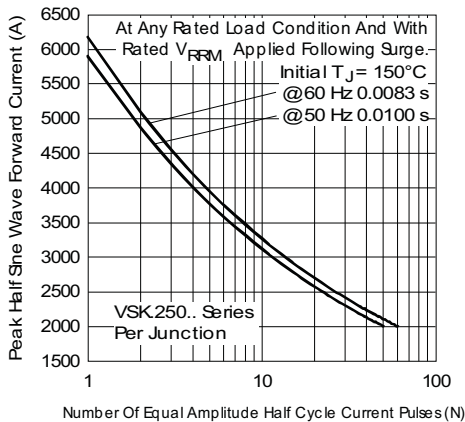

Fig. 8 - Maximum Non-Repetitive Surge Current

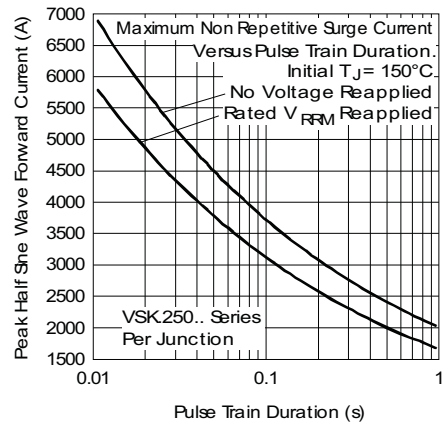

Fig. 9 - Maximum Non-Repetitive Surge Current

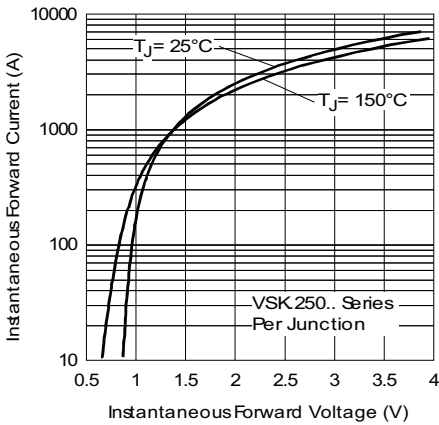

Fig. 10 - Forward Voltage Drop Characteristics

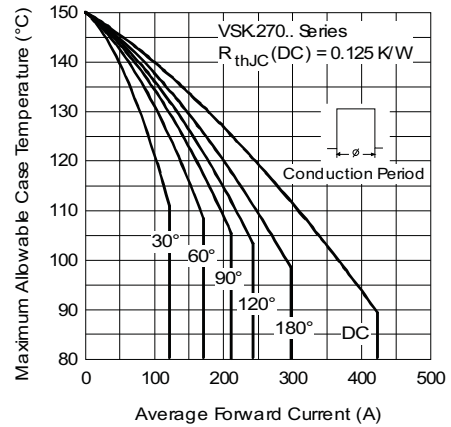

Fig. 13 - Current Ratings Characteristics

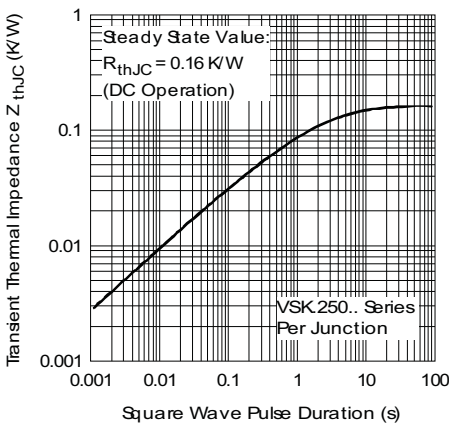

Fig. 11 - Thermal Impedance  $Z_{thJC}$  Characteristics

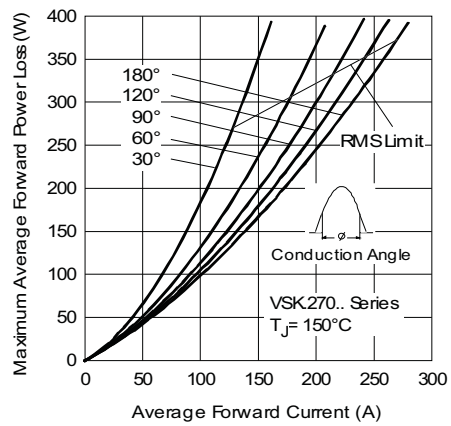

Fig. 14 - Forward Power Loss Characteristics

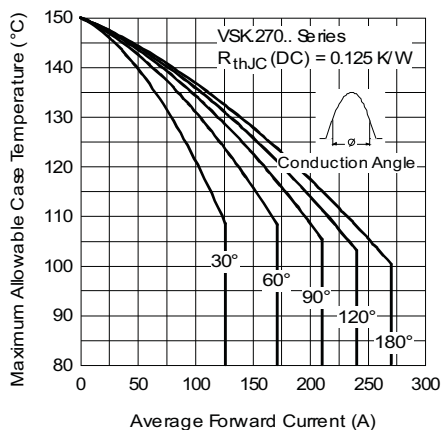

Fig. 12 - Current Ratings Characteristics

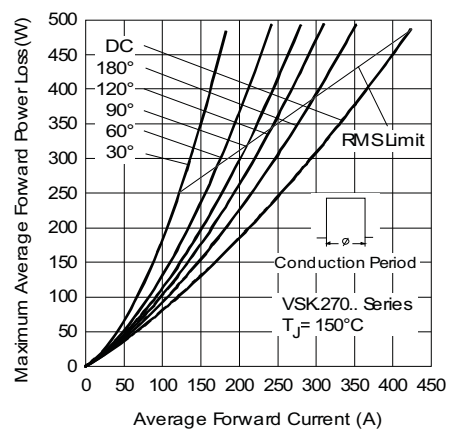

Fig. 15 - Forward Power Loss Characteristics

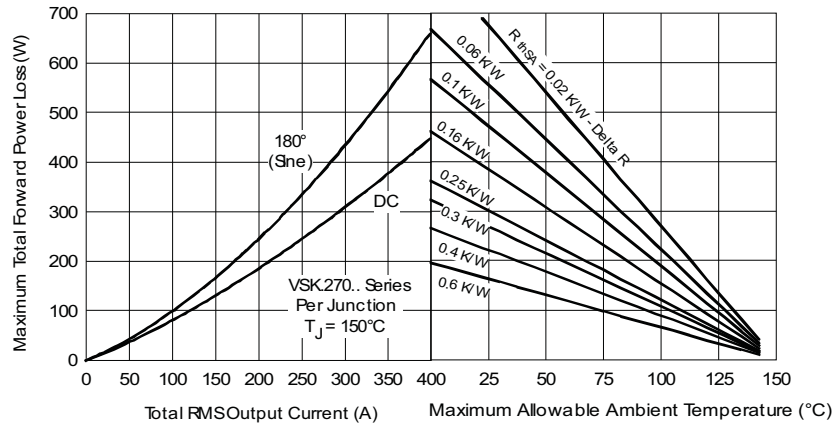

Fig. 16 - Forward Power Loss Characteristics

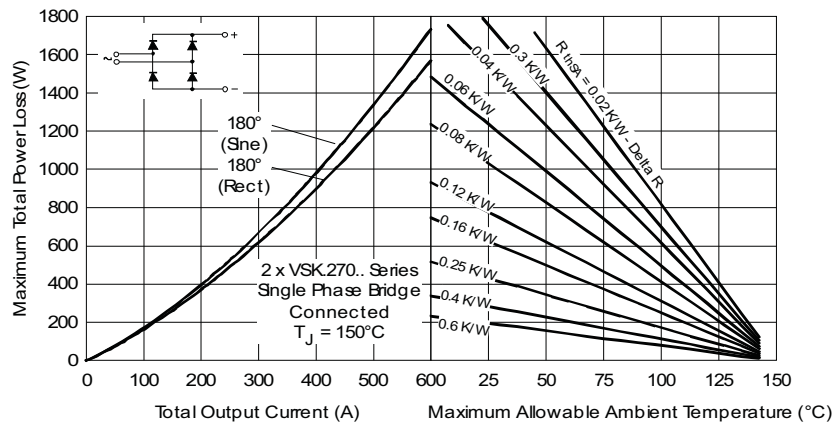

Fig. 17 - Forward Power Loss Characteristics

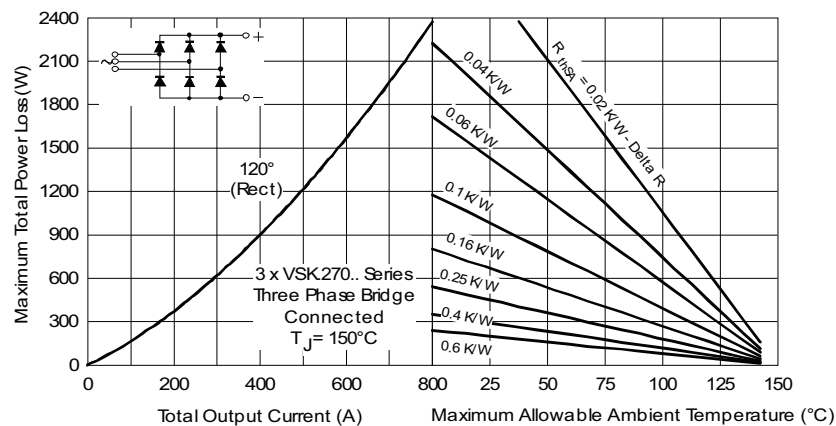

Fig. 18 - Forward Power Loss Characteristics

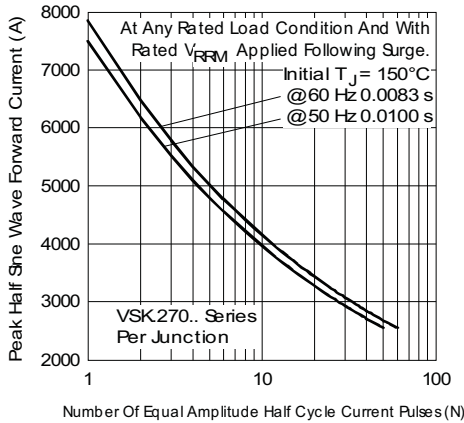

Fig. 19 - Maximum Non-Repetitive Surge Current

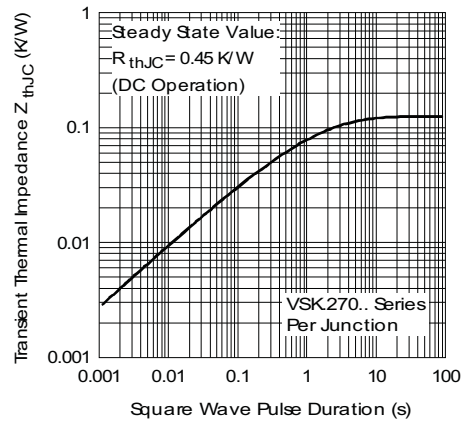

Fig. 22 - Thermal Impedance  $Z_{thJC}$  Characteristics

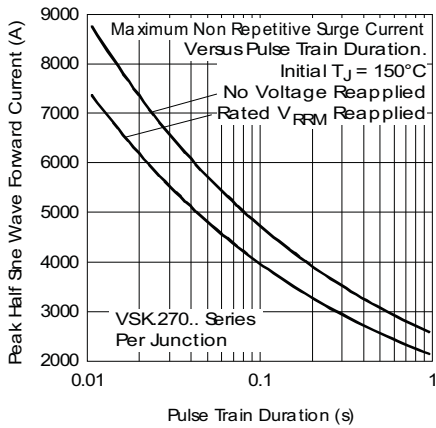

Fig. 20 - Maximum Non-Repetitive Surge Current

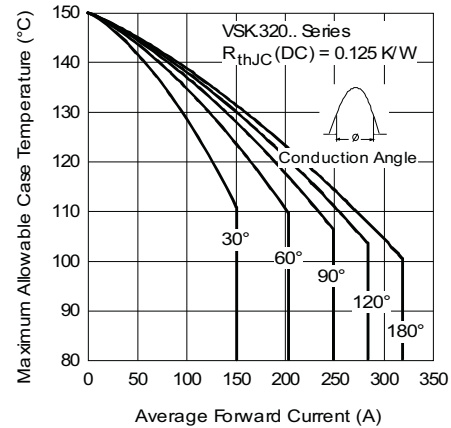

Fig. 23 - Current Ratings Characteristics

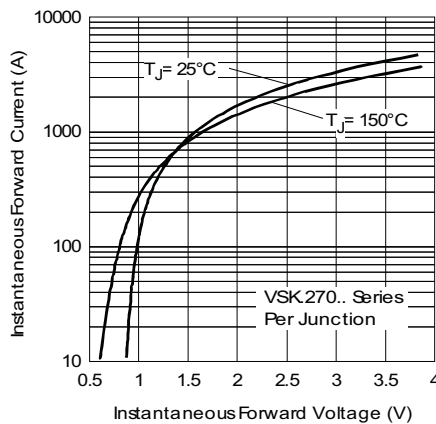

Fig. 21 - Forward Voltage Drop Characteristics

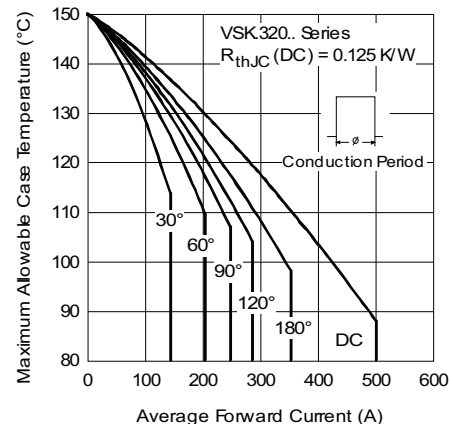

Fig. 24 - Current Ratings Characteristics



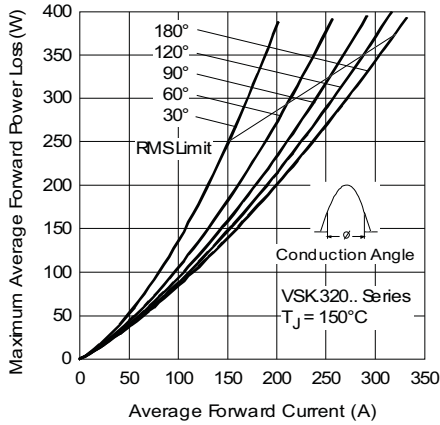

Fig. 25 - Forward Power Loss Characteristics

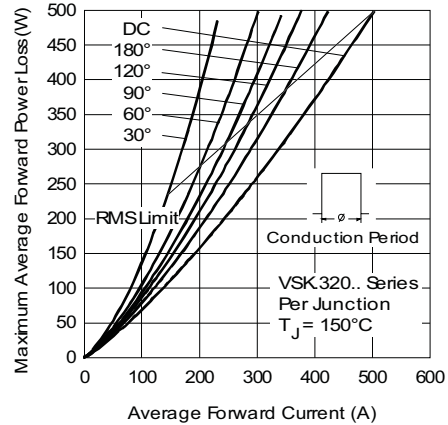

Fig. 26 - Forward Power Loss Characteristics

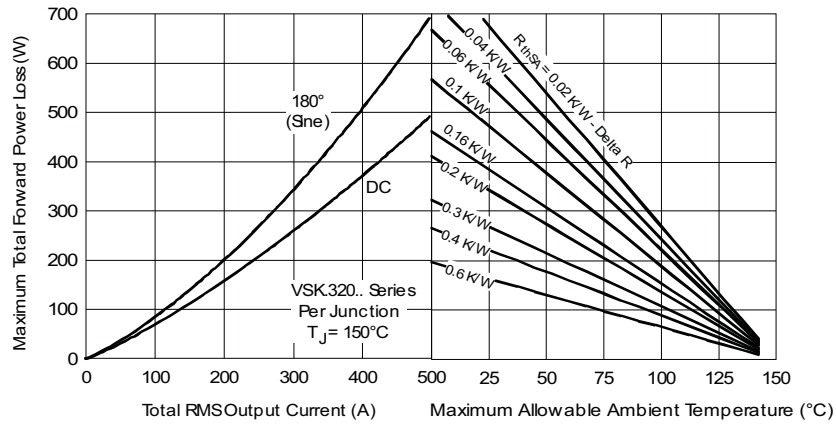

Fig. 27 - Forward Power Loss Characteristics

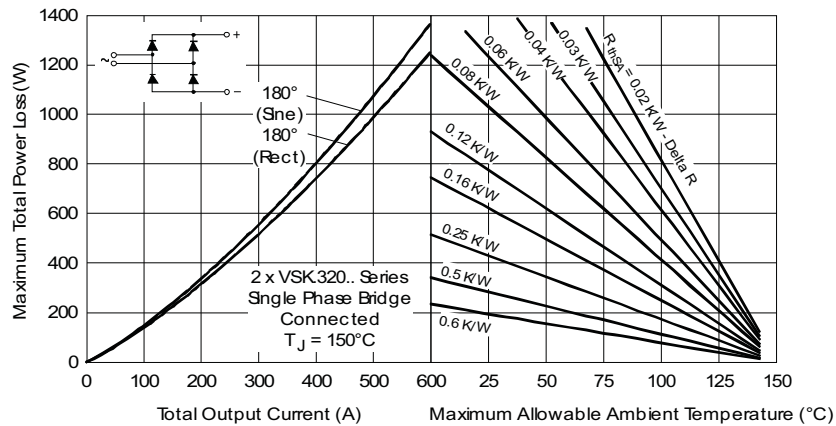

Fig. 28 - Forward Power Loss Characteristics

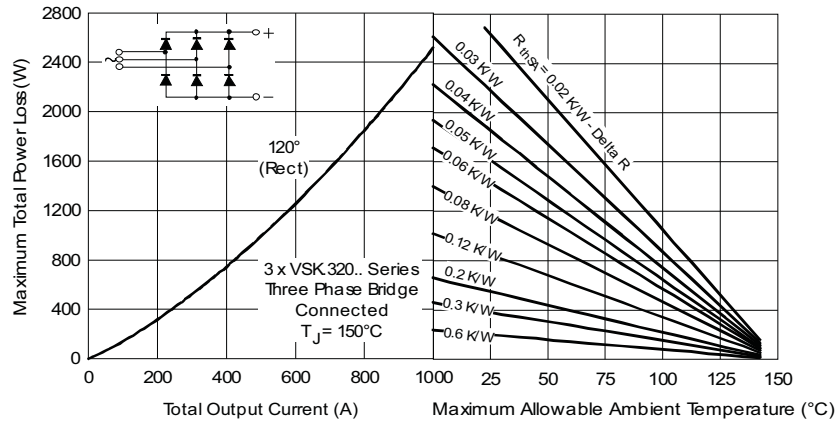

Fig. 29 - Forward Power Loss Characteristics

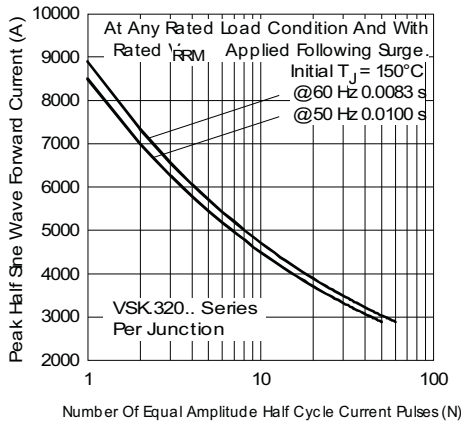

Fig. 30 - Maximum Non-Repetitive Surge Current

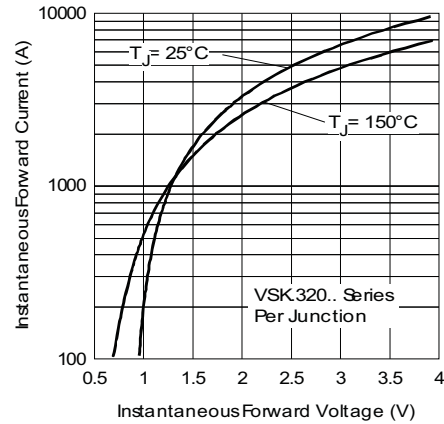

Fig. 32 - Forward Voltage Drop Characteristics

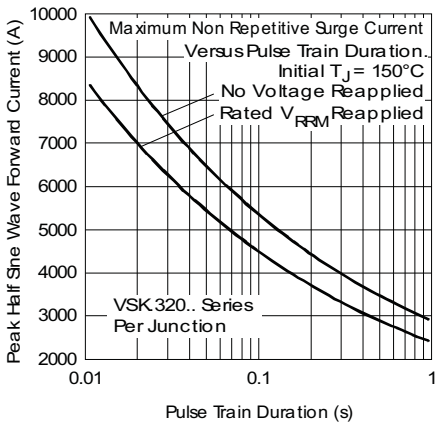

Fig. 31 - Maximum Non-Repetitive Surge Current

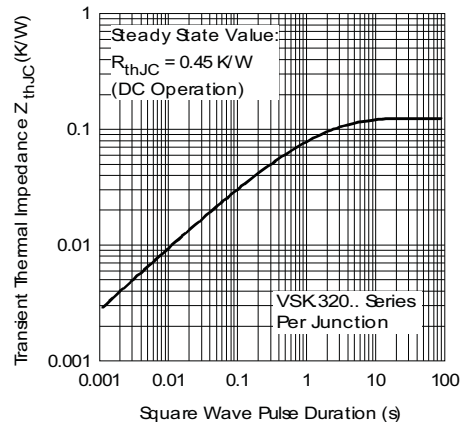

Fig. 33 - Thermal Impedance  $Z_{\theta JC}$  Characteristics



**ORDERING INFORMATION TABLE**

|             |              |           |            |          |           |            |
|-------------|--------------|-----------|------------|----------|-----------|------------|
| Device code | <b>VS-VS</b> | <b>KD</b> | <b>320</b> | <b>-</b> | <b>24</b> | <b>PbF</b> |
|             | ①            | ②         | ③          |          | ④         | ⑤          |

- 1** - Vishay Semiconductors product
- 2** - Circuit configuration (see Circuit Configuration table)
- 3** - Current rating:  $I_{F(AV)}$  rounded
- 4** - Voltage code x 100 =  $V_{RRM}$  (see Voltage Ratings table)
- 5** - Lead (Pb)-free

| <b>CIRCUIT CONFIGURATION</b> |                                   |   |
|------------------------------|-----------------------------------|---|
| <b>CIRCUIT DESCRIPTION</b>   | <b>CIRCUIT CONFIGURATION CODE</b> | <b>CIRCUIT DRAWING</b>                            |
| Two diodes doubler circuit   | KD                                | <p style="text-align: center;"><b>VSKD...</b></p> |
| Two diodes common cathode    | KC                                | <p style="text-align: center;"><b>VSKC...</b></p> |
| Single diode                 | KE                                | <p style="text-align: center;"><b>VSKE...</b></p> |

| <b>LINKS TO RELATED DOCUMENTS</b> |  |
|-----------------------------------|--|
| Dimensions                        | <a href="http://www.vishay.com/doc?95086">www.vishay.com/doc?95086</a> |

## MAGN-A-PAK

**DIMENSIONS** in millimeters (inches)

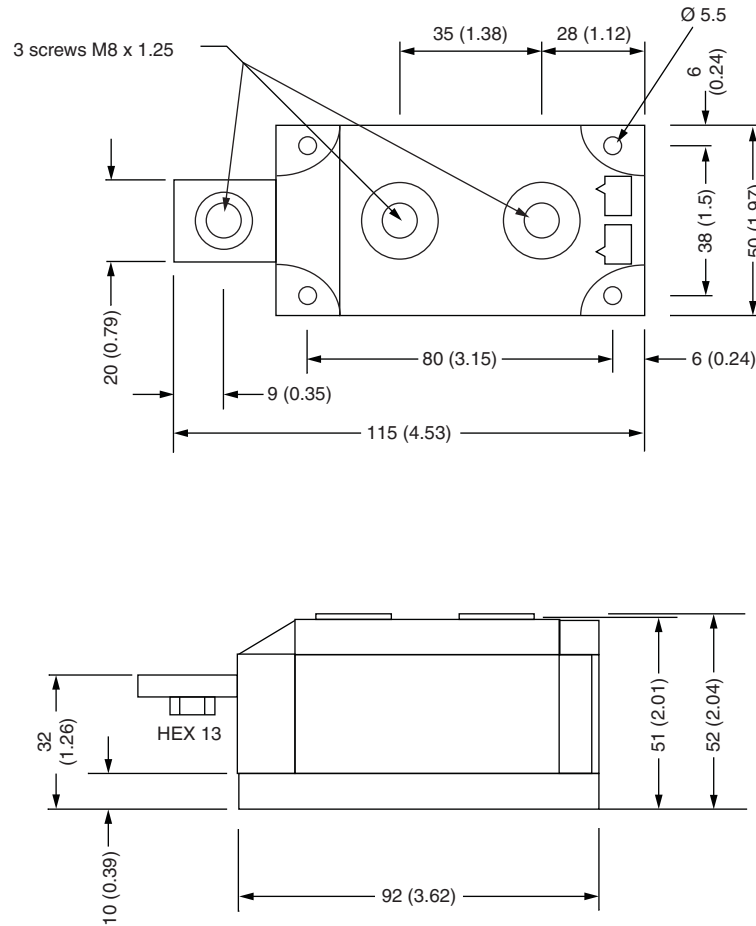

### Notes

- Dimensions are nominal
- Full engineering drawings are available on request
- UL identification number for gate and cathode wire: UL 1385
- UL identification number for package: UL 94 V-0



## Disclaimer

ALL PRODUCT, PRODUCT SPECIFICATIONS AND DATA ARE SUBJECT TO CHANGE WITHOUT NOTICE TO IMPROVE RELIABILITY, FUNCTION OR DESIGN OR OTHERWISE.

Vishay Intertechnology, Inc., its affiliates, agents, and employees, and all persons acting on its or their behalf (collectively, "Vishay"), disclaim any and all liability for any errors, inaccuracies or incompleteness contained in any datasheet or in any other disclosure relating to any product.

Vishay makes no warranty, representation or guarantee regarding the suitability of the products for any particular purpose or the continuing production of any product. To the maximum extent permitted by applicable law, Vishay disclaims (i) any and all liability arising out of the application or use of any product, (ii) any and all liability, including without limitation special, consequential or incidental damages, and (iii) any and all implied warranties, including warranties of fitness for particular purpose, non-infringement and merchantability.

Statements regarding the suitability of products for certain types of applications are based on Vishay's knowledge of typical requirements that are often placed on Vishay products in generic applications. Such statements are not binding statements about the suitability of products for a particular application. It is the customer's responsibility to validate that a particular product with the properties described in the product specification is suitable for use in a particular application. Parameters provided in datasheets and / or specifications may vary in different applications and performance may vary over time. All operating parameters, including typical parameters, must be validated for each customer application by the customer's technical experts. Product specifications do not expand or otherwise modify Vishay's terms and conditions of purchase, including but not limited to the warranty expressed therein.

Hyperlinks included in this datasheet may direct users to third-party websites. These links are provided as a convenience and for informational purposes only. Inclusion of these hyperlinks does not constitute an endorsement or an approval by Vishay of any of the products, services or opinions of the corporation, organization or individual associated with the third-party website. Vishay disclaims any and all liability and bears no responsibility for the accuracy, legality or content of the third-party website or for that of subsequent links.

Except as expressly indicated in writing, Vishay products are not designed for use in medical, life-saving, or life-sustaining applications or for any other application in which the failure of the Vishay product could result in personal injury or death. Customers using or selling Vishay products not expressly indicated for use in such applications do so at their own risk. Please contact authorized Vishay personnel to obtain written terms and conditions regarding products designed for such applications.

No license, express or implied, by estoppel or otherwise, to any intellectual property rights is granted by this document or by any conduct of Vishay. Product names and markings noted herein may be trademarks of their respective owners.