



## Stud Thyristor

## Line Thyristor

### SKT 50

### Features

- Hermetic metal case with glass insulator
- Threaded stud ISO M8 or UNF 1/4-28
- International standard case

### Typical Applications\*

- DC motor control (e. g. for machine tools)
- Controlled rectifiers (e. g. for battery charging)
- AC controllers (e. g. for temperature control)
- Recommended snubber network e. g. for  $V_{VRMS} \leq 400$  V:  
 $R = 68 \Omega / 11$  W,  $C = 0,22 \mu F$

1) Available with UNF thread 1/4-28 UNF2A, e. g. SKT 50/06D UNF

$V_{RSM}$ V	$V_{RRM}, V_{DRM}$ V	$I_{TRMS} = 78$ A (maximum value for continuous operation) $I_{TAV} = 50$ A (sin. 180; $T_c = 78$ °C)	
700	600	SKT 50/06D <sup>1)</sup>	
900	800	SKT 50/08D	
1300	1200	SKT 50/12E <sup>1)</sup>	
1500	1400	SKT 50/14E <sup>1)</sup>	
1700	1600	SKT 50/16E <sup>1)</sup>	
1900	1800	SKT 50/18E	

Symbol	Conditions	Values	Units
$I_{TAV}$	sin. 180; $T_c = 100$ (85) °C;	33 (45)	A
$I_D$	K5; $T_a = 45$ °C; B2 / B6 K3; $T_a = 45$ °C; B2 / B6	25 / 36 36 / 50	A
$I_{RMS}$	K3; $T_a = 45$ °C; W1C	40	A
$I_{TSM}$	$T_{vj} = 25$ °C; 10 ms $T_{vj} = 130$ °C; 10 ms	1050 900	A
$i^2t$	$T_{vj} = 25$ °C; 8,35 ... 10 ms $T_{vj} = 130$ °C; 8,35 ... 10 ms	5000 4000	A <sup>2</sup> s
$V_T$	$T_{vj} = 25$ °C; $I_T = 120$ A	max. 1,8	V
$V_{T(TO)}$	$T_{vj} = 130$ °C	max. 1,1	V
$r_T$	$T_{vj} = 130$ °C	max. 5	mΩ
$I_{DD}, I_{RD}$	$T_{vj} = 130$ °C; $V_{RD} = V_{RRM}, V_{DD} = V_{DRM}$	max. 8	mA
$t_{gd}$	$T_{vj} = 25$ °C; $I_G = 1$ A; $di_G/dt = 1$ A/μs	1	μs
$t_{gr}$	$V_D = 0,67 * V_{DRM}$	1,5	μs
$(di/dt)_{cr}$	$T_{vj} = 130$ °C	max. 50	A/μs
$(dv/dt)_{cr}$	$T_{vj} = 130$ °C; SKT ...D / SKT ...E	max. 500 / 1000	V/μs
$t_q$	$T_{vj} = 130$ °C,	100	μs
$I_H$	$T_{vj} = 25$ °C; typ. / max.	100 / 200	mA
$I_L$	$T_{vj} = 25$ °C; $R_G = 33 \Omega$ ; typ. / max.	250 / 400	mA
$V_{GT}$	$T_{vj} = 25$ °C; d.c.	min. 3	V
$I_{GT}$	$T_{vj} = 25$ °C; d.c.	min. 150	mA
$V_{GD}$	$T_{vj} = 130$ °C; d.c.	max. 0,25	V
$I_{GD}$	$T_{vj} = 130$ °C; d.c.	max. 5	mA
$R_{th(j-c)}$	cont.	0,57	K/W
$R_{th(j-c)}$	sin. 180	0,6	K/W
$R_{th(j-c)}$	rec. 120	0,65	K/W
$R_{th(c-s)}$		0,2	K/W
$T_{vj}$		- 40 ... + 130	°C
$T_{stg}$		- 55 ... + 150	°C
$V_{isol}$		-	V~
$M_s$	to heatsink	4 (UNF: 2,5)	Nm
$a$		5 * 9,81	m/s <sup>2</sup>
$m$	approx.	22	g
Case		B 3	

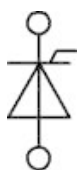

SKT

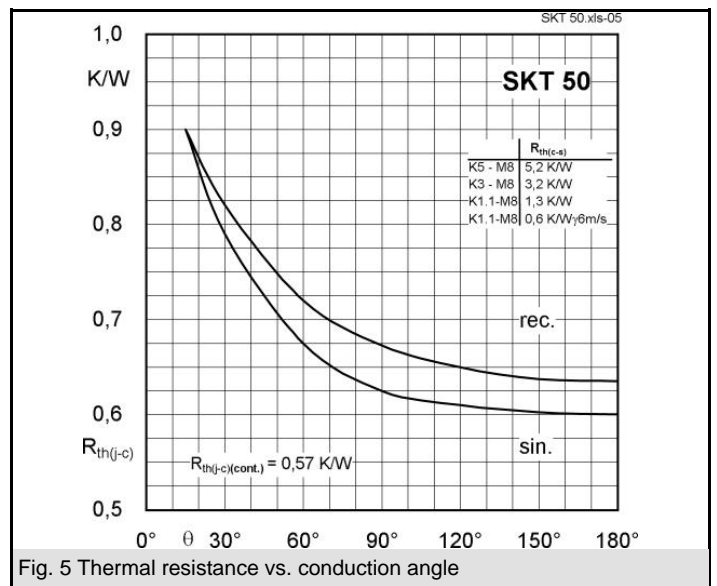
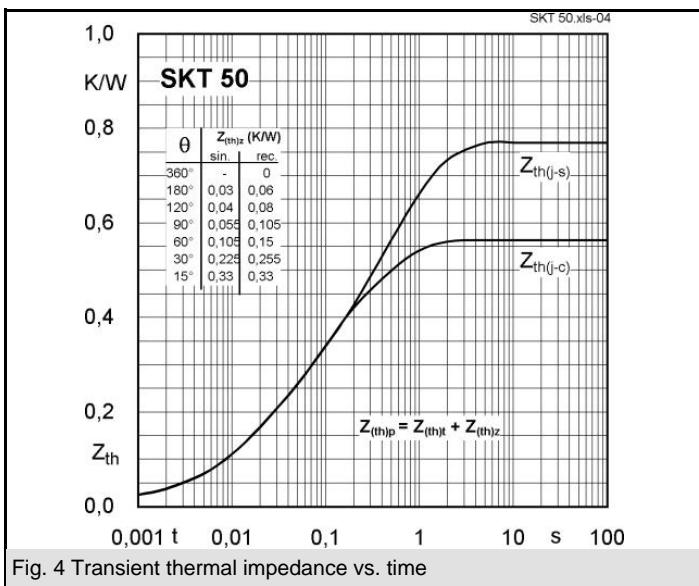
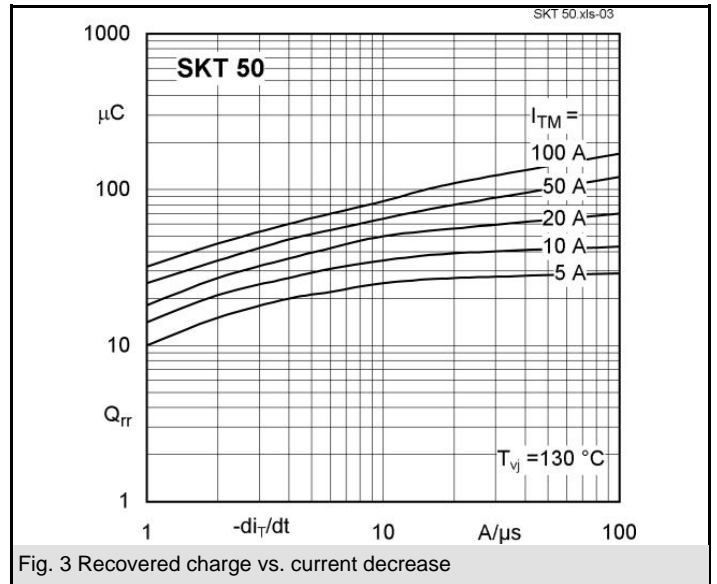
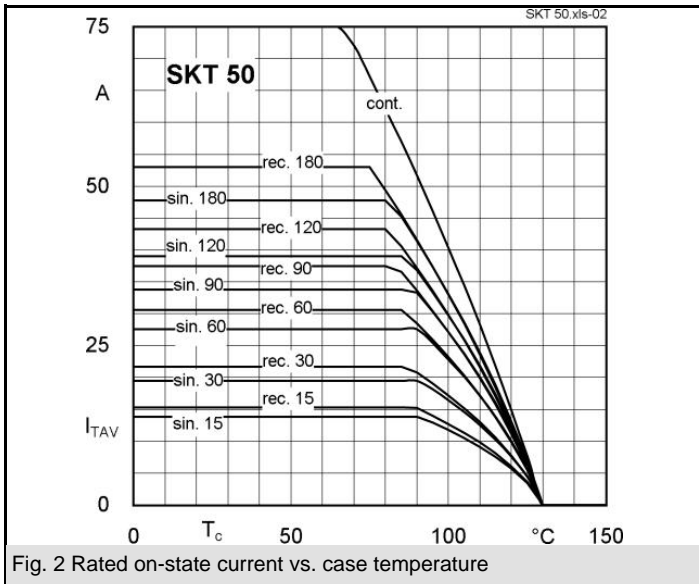
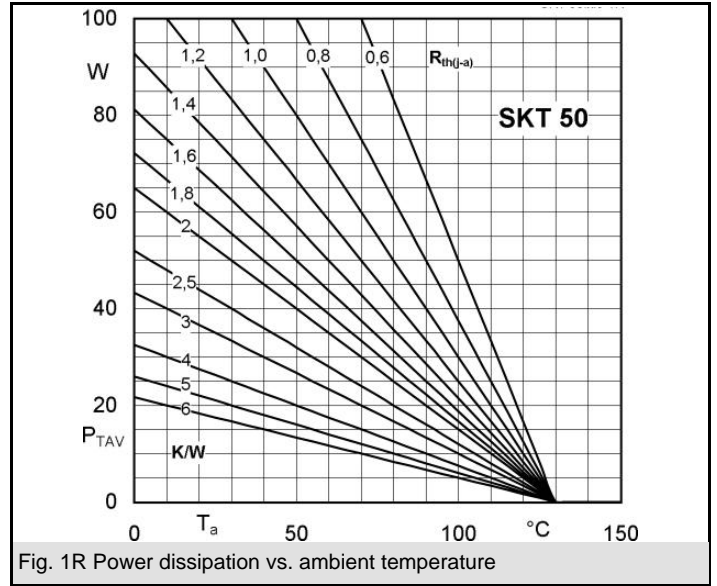
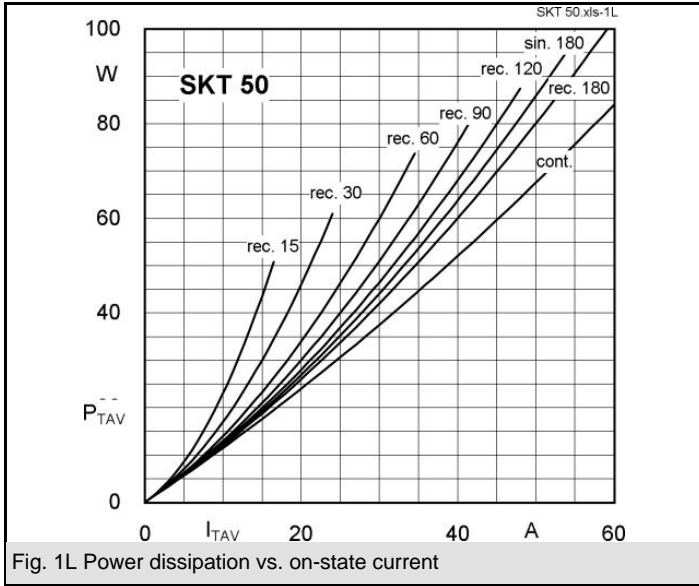

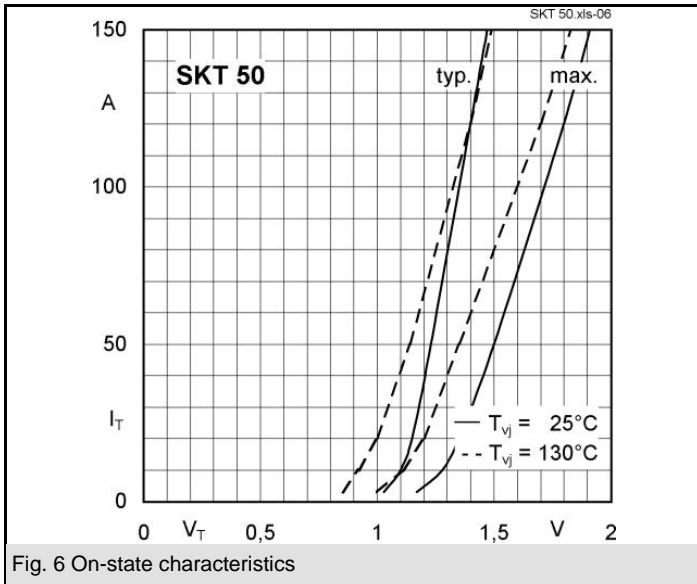

Fig. 6 On-state characteristics

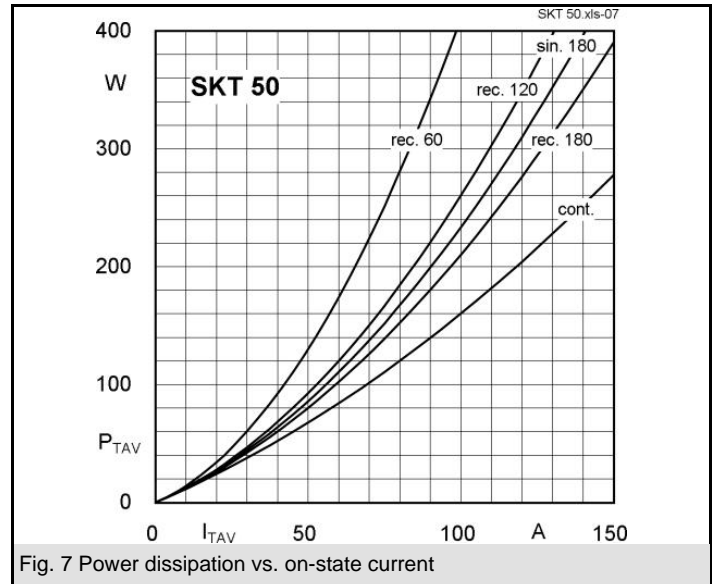

Fig. 7 Power dissipation vs. on-state current

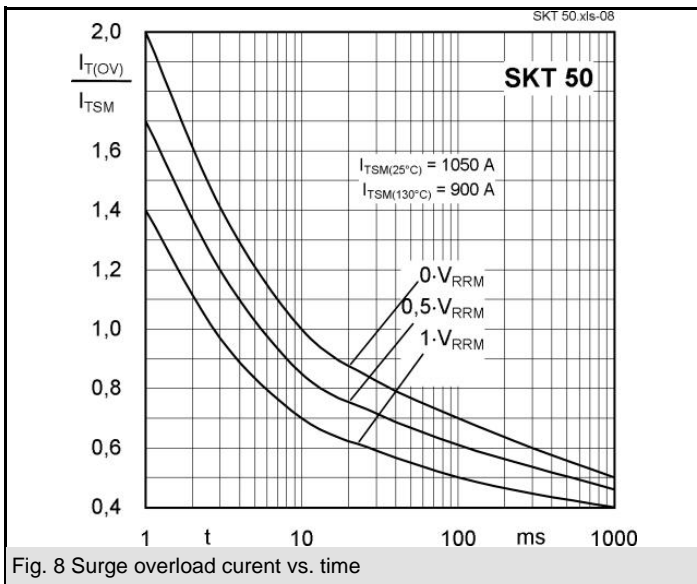
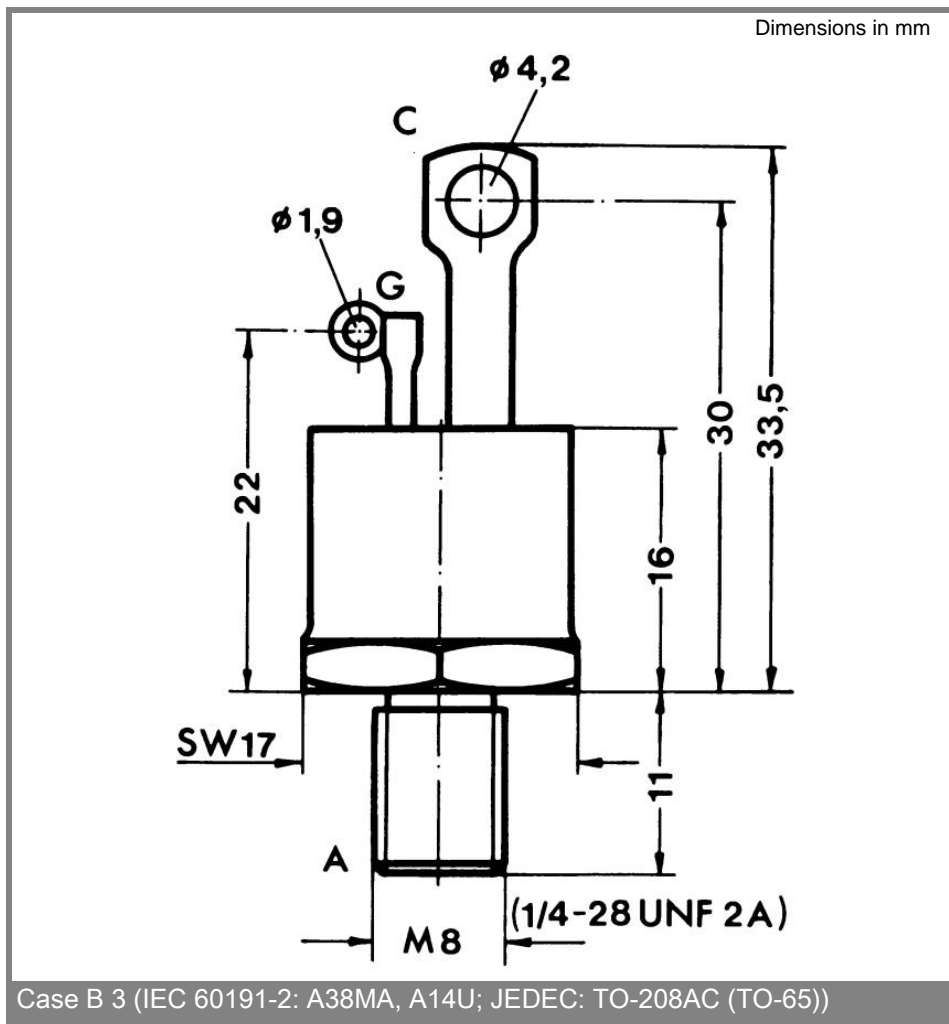
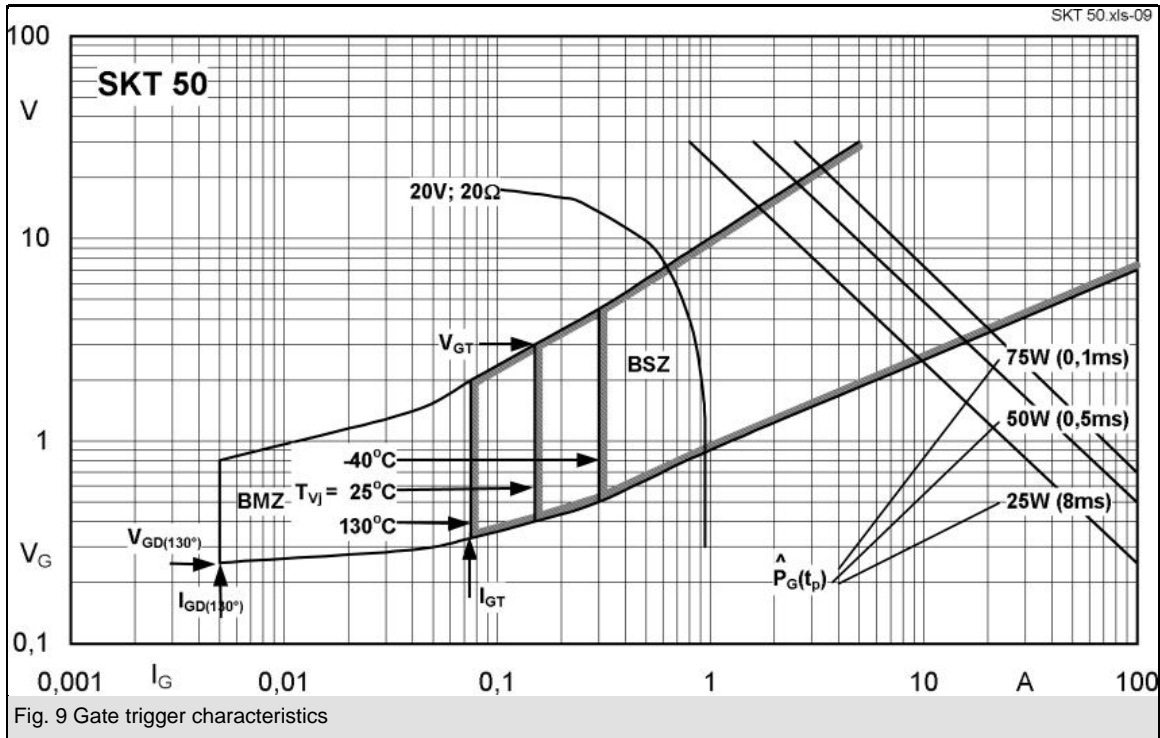

Fig. 8 Surge overload current vs. time



\* The specifications of our components may not be considered as an assurance of component characteristics. Components have to be tested for the respective application. Adjustments may be necessary. The use of SEMIKRON

products in life support appliances and systems is subject to prior specification and written approval by SEMIKRON. We therefore strongly recommend prior consultation of our personal.