

SKM 300GB066D

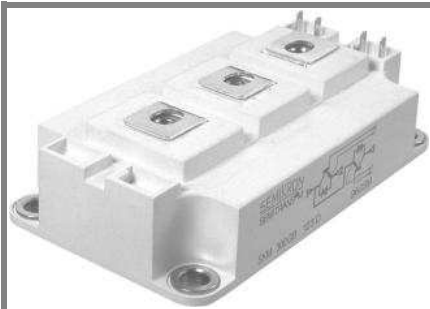

SEMITRANS® 3

Trench IGBT Modules

SKM 300GB066D

Features

- Homogeneous Si
- Trench = Trenchgate technology
- $V_{CE(sat)}$ with positive temperature coefficient
- High short circuit capability, self limiting to $6 \times I_C$

Typical Applications*

- AC inverter drives
- UPS
- Electronic welders

Remarks

- Case temperature limited to $T_C = 125^\circ\text{C}$ max, recommended $T_{op} = -40 \dots +150^\circ\text{C}$
- Product reliability results are valid for $T_j \leq 150^\circ\text{C}$
- Short circuit data: $t_p \leq 6 \text{ s}$; $V_{GE} \leq 15\text{V}$; $T_j = 150^\circ\text{C}$; $V_{CC} \leq 360\text{V}$, use of soft R_G necessary!
- Take care of over-voltage caused by stray inductances

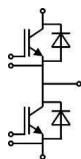

GB

| Absolute Maximum Ratings | | $T_{case} = 25^\circ\text{C}$, unless otherwise specified | | |
|--------------------------|--|--|------------------|---|
| Symbol | Conditions | Values | Units | |
| IGBT | | | | |
| V_{CES} | $T_j = 25^\circ\text{C}$ | 600 | V | |
| I_C | $T_j = 175^\circ\text{C}$ | $T_c = 25^\circ\text{C}$ | 390 | A |
| | | $T_c = 80^\circ\text{C}$ | 300 | A |
| I_{CRM} | $I_{CRM} = 2 \times I_{Cnom}$ | 600 | A | |
| V_{GES} | | ± 20 | V | |
| t_{psc} | $V_{CC} = 360 \text{ V}$; $V_{GE} \leq 15 \text{ V}$; $T_j = 150^\circ\text{C}$ $V_{CES} < 600 \text{ V}$ | 6 | s | |
| Inverse Diode | | | | |
| I_F | $T_j = 175^\circ\text{C}$ | $T_c = 25^\circ\text{C}$ | 350 | A |
| | | $T_c = 80^\circ\text{C}$ | 250 | A |
| I_{FRM} | $I_{FRM} = 2 \times I_{Fnom}$ | 600 | A | |
| I_{FSM} | $t_p = 10 \text{ ms}$; sin. | $T_j = 175^\circ\text{C}$ | 1760 | A |
| Module | | | | |
| $I_{t(RMS)}$ | | 500 | A | |
| T_{vj} | | -40 ... +175 | $^\circ\text{C}$ | |
| T_{stg} | | -40 ... +125 | $^\circ\text{C}$ | |
| V_{isol} | AC, 1 min. | 4000 | V | |

| Characteristics | | $T_{case} = 25^\circ\text{C}$, unless otherwise specified | | | |
|-----------------|--|--|------|------|------------------|
| Symbol | Conditions | min. | typ. | max. | Units |
| IGBT | | | | | |
| $V_{GE(th)}$ | $V_{GE} = V_{CES}$, $I_C = 4,8 \text{ mA}$ | 5 | 5,8 | 6,5 | V |
| I_{CES} | $V_{GE} = 0 \text{ V}$, $V_{CE} = V_{CES}$ | $T_j = 25^\circ\text{C}$ | 0,15 | 0,45 | mA |
| | | $T_j = 150^\circ\text{C}$ | 0,85 | 0,9 | V |
| V_{CE0} | | | | | |
| r_{CE} | $V_{GE} = 15 \text{ V}$ | $T_j = 25^\circ\text{C}$ | 1,8 | 3 | $\text{m}\Omega$ |
| | | $T_j = 150^\circ\text{C}$ | 2,7 | 3,8 | $\text{m}\Omega$ |
| $V_{CE(sat)}$ | $I_{Cnom} = 300 \text{ A}$, $V_{GE} = 15 \text{ V}$ | $T_j = 25^\circ\text{C}_{chiplev.}$ | 1,45 | 1,9 | V |
| | | $T_j = 150^\circ\text{C}_{chiplev.}$ | 1,7 | 2,1 | V |
| C_{res} | $V_{CE} = 25$, $V_{GE} = 0 \text{ V}$ | $f = 1 \text{ MHz}$ | 18,5 | | nF |
| C_{oes} | | | 1,2 | | nF |
| C_{res} | | | 0,55 | | nF |
| Q_G | $V_{GE} = -8\text{V} \dots +15\text{V}$ | | 2400 | | nC |
| R_{Gint} | $T_j = ^\circ\text{C}$ | | 1 | | Ω |
| $t_{d(on)}$ | $R_{Gon} = 2,4 \Omega$ | $V_{CC} = 300\text{V}$ $I_C = 300\text{A}$ | 150 | | ns |
| t_r | | | 48 | | ns |
| E_{on} | $R_{Goff} = 2,4 \Omega$ | $T_j = 150^\circ\text{C}$ $V_{GE} = -8\text{V}/+15\text{V}$ | 7,5 | | mJ |
| $t_{d(off)}$ | | | 540 | | ns |
| t_f | | | 53 | | ns |
| E_{off} | | | 11,5 | | mJ |
| $R_{th(j-c)}$ | per IGBT | | | 0,15 | K/W |

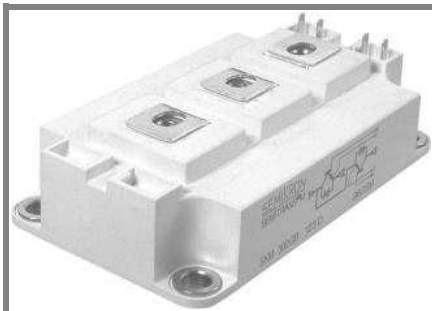

SEMITRANS® 3

Trench IGBT Modules

SKM 300GB066D

Features

- Homogeneous Si
- Trench = Trenchgate technology
- $V_{CE(sat)}$ with positive temperature coefficient
- High short circuit capability, self limiting to $6 \times I_C$

Typical Applications*

- AC inverter drives
- UPS
- Electronic welders

Remarks

- Case temperature limited to $T_C = 125^\circ\text{C}$ max, recommended $T_{op} = -40 \dots +150^\circ\text{C}$
- Product reliability results are valid for $T_j \leq 150^\circ\text{C}$
- Short circuit data: $t_p \leq 6 \text{ s}$; $V_{GE} \leq 15\text{V}$; $T_j = 150^\circ\text{C}$; $V_{CC} \leq 360\text{V}$, use of soft R_G necessary !
- Take care of over-voltage caused by stray inductances



GB

Characteristics

| Symbol | Conditions | min. | typ. | max. | Units |
|----------------------|---|------|------|-------|-------|
| Inverse Diode | | | | | |
| $V_F = V_{EC}$ | $I_{Fnom} = 300 \text{ A}$; $V_{GE} = 0 \text{ V}$ $T_j = 25^\circ\text{C}_{chiplev.}$ | | 1,4 | 1,6 | V |
| V_{F0} | $T_j = 25^\circ\text{C}$ | | 0,95 | 1 | V |
| r_F | $T_j = 25^\circ\text{C}$ | | 1,5 | 2 | mΩ |
| I_{RRM} | $I_F = 300 \text{ A}$ $T_j = 150^\circ\text{C}$ | | 340 | | A |
| Q_{rr} | $di/dt = 7000 \text{ A/s}$ | | 47 | | C |
| E_{rr} | $V_{GE} = -8 \text{ V}$; $V_{CC} = 300 \text{ V}$ | | 10,5 | | mJ |
| $R_{th(j-c)D}$ | per diode | | | 0,25 | K/W |
| Module | | | | | |
| L_{CE} | | | 15 | 20 | nH |
| R_{CC+EE} | res., terminal-chip $T_{case} = 25^\circ\text{C}$ | | 0,35 | | mΩ |
| | $T_{case} = 125^\circ\text{C}$ | | 0,5 | | mΩ |
| $R_{th(c-s)}$ | per module | | | 0,038 | K/W |
| M_s | to heat sink M6 | 3 | | 5 | Nm |
| M_t | to terminals M6 | 2,5 | | 5 | Nm |
| w | | | | 325 | g |

This is an electrostatic discharge sensitive device (ESDS), international standard IEC 60747-1, Chapter IX.

* The specifications of our components may not be considered as an assurance of component characteristics. Components have to be tested for the respective application. Adjustments may be necessary. The use of SEMIKRON products in life support appliances and systems is subject to prior specification and written approval by SEMIKRON. We therefore strongly recommend prior consultation of our personal.

SKM 300GB066D

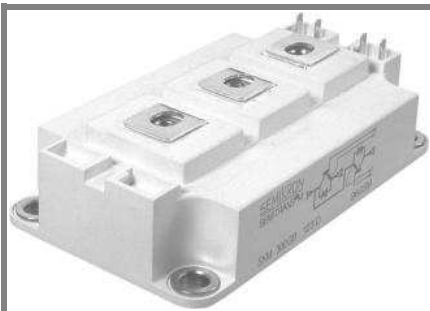

SEMITRANS® 3

Trench IGBT Modules

SKM 300GB066D

Features

- Homogeneous Si
- Trench = Trenchgate technology
- $V_{CE(sat)}$ with positive temperature coefficient
- High short circuit capability, self limiting to $6 \times I_C$

Typical Applications*

- AC inverter drives
- UPS
- Electronic welders

Remarks

- Case temperature limited to $T_C = 125^\circ\text{C}$ max, recommended $T_{op} = -40 \dots +150^\circ\text{C}$
- Product reliability results are valid for $T_j \leq 150^\circ\text{C}$
- Short circuit data: $t_p \leq 6$ s; $V_{GE} \leq 15\text{V}$; $T_j = 150^\circ\text{C}$; $V_{CC} \leq 360\text{V}$, use of soft R_G necessary !
- Take care of over-voltage caused by stray inductances

| Z_{th} | | | |
|---------------------|------------|--------|-------|
| Symbol | Conditions | Values | Units |
| $Z_{th(j-c)I}$ | | | |
| $R_{\theta j-c}$ | $i = 1$ | 107 | mk/W |
| $R_{\theta j-c}$ | $i = 2$ | 30 | mk/W |
| $R_{\theta j-c}$ | $i = 3$ | 11,6 | mk/W |
| $R_{\theta j-c}$ | $i = 4$ | 1,4 | mk/W |
| $\tau_{\theta j-c}$ | $i = 1$ | 0,054 | s |
| $\tau_{\theta j-c}$ | $i = 2$ | 0,0144 | s |
| $\tau_{\theta j-c}$ | $i = 3$ | 0,0007 | s |
| $\tau_{\theta j-c}$ | $i = 4$ | 0,0004 | s |
| $Z_{th(j-c)D}$ | | | |
| $R_{\theta j-c}$ | $i = 1$ | 140 | mk/W |
| $R_{\theta j-c}$ | $i = 2$ | 82 | mk/W |
| $R_{\theta j-c}$ | $i = 3$ | 23,5 | mk/W |
| $R_{\theta j-c}$ | $i = 4$ | 4,5 | mk/W |
| $\tau_{\theta j-c}$ | $i = 1$ | 0,054 | s |
| $\tau_{\theta j-c}$ | $i = 2$ | 0,01 | s |
| $\tau_{\theta j-c}$ | $i = 3$ | 0,0015 | s |
| $\tau_{\theta j-c}$ | $i = 4$ | 0,0002 | s |

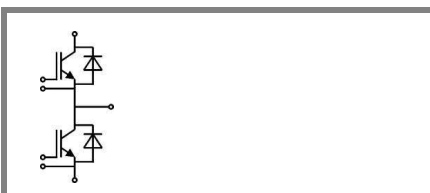

GB

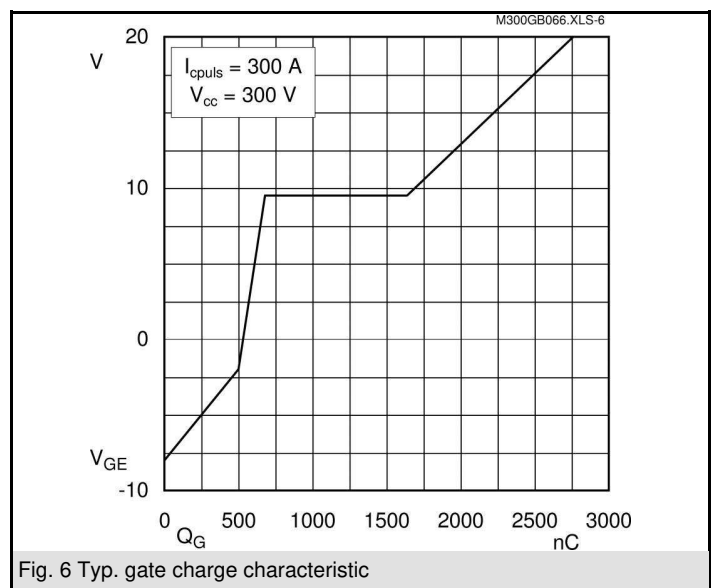
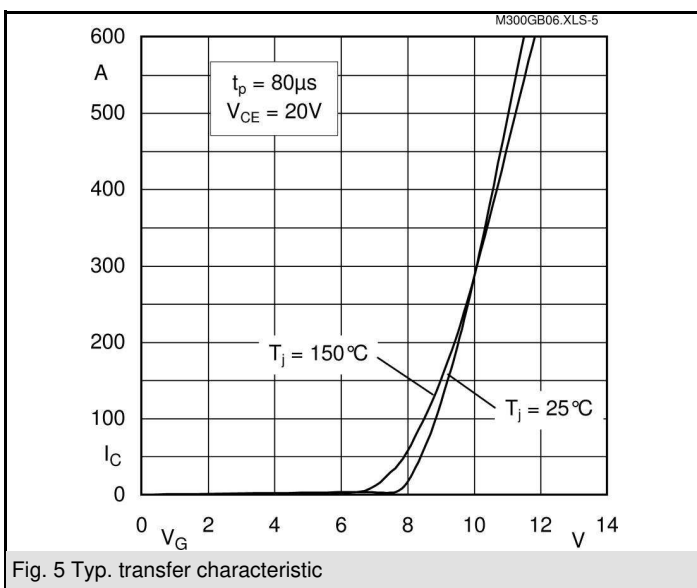
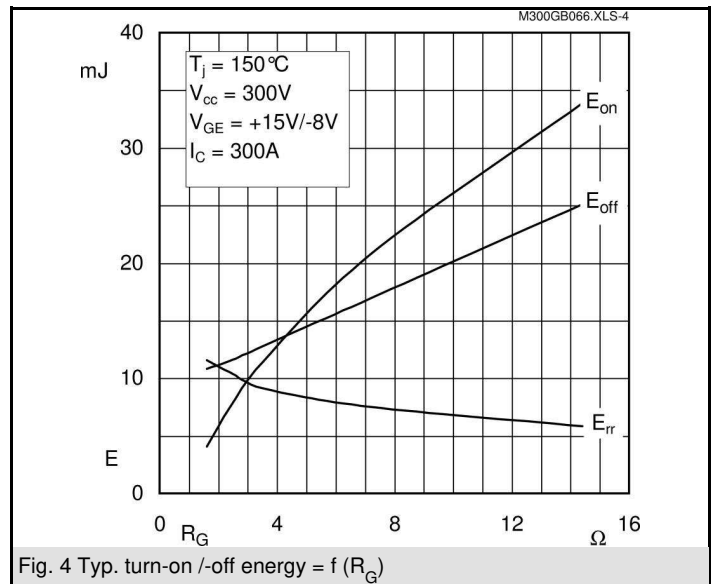
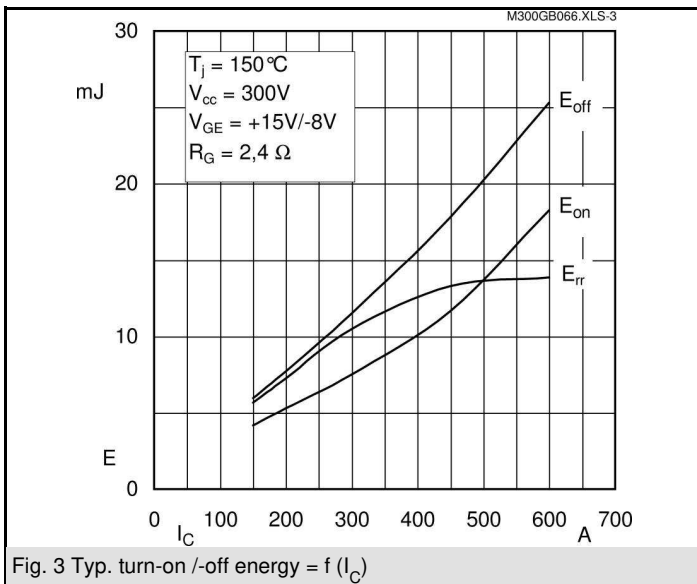
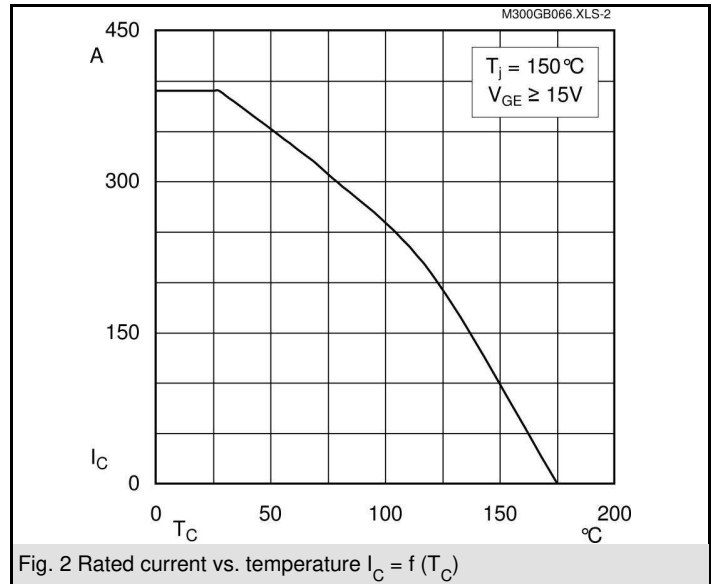
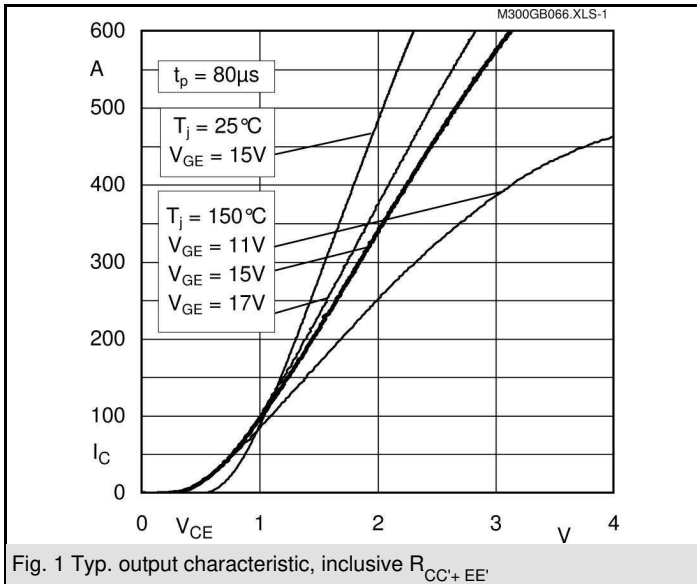

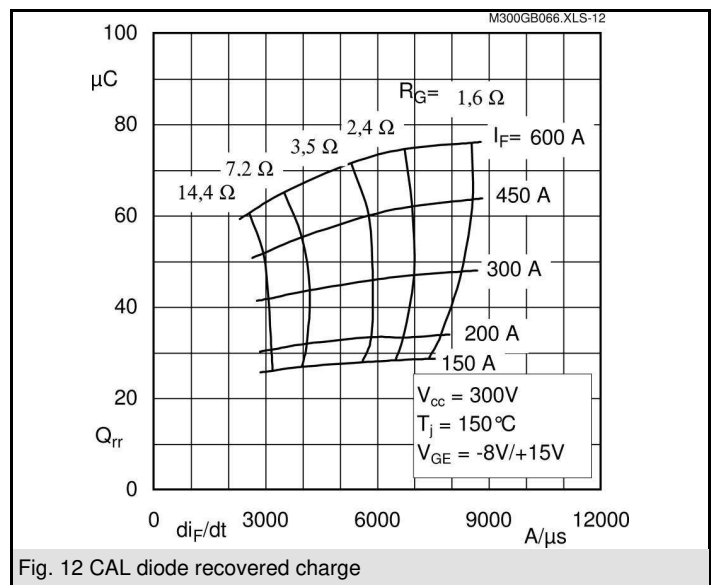
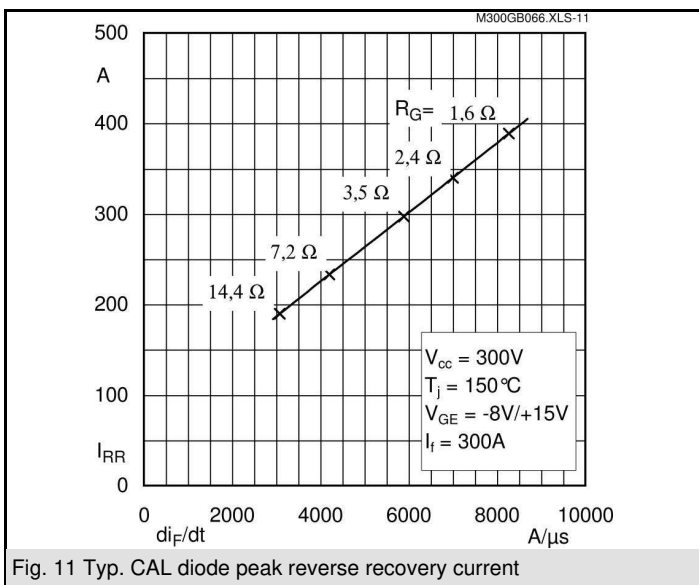
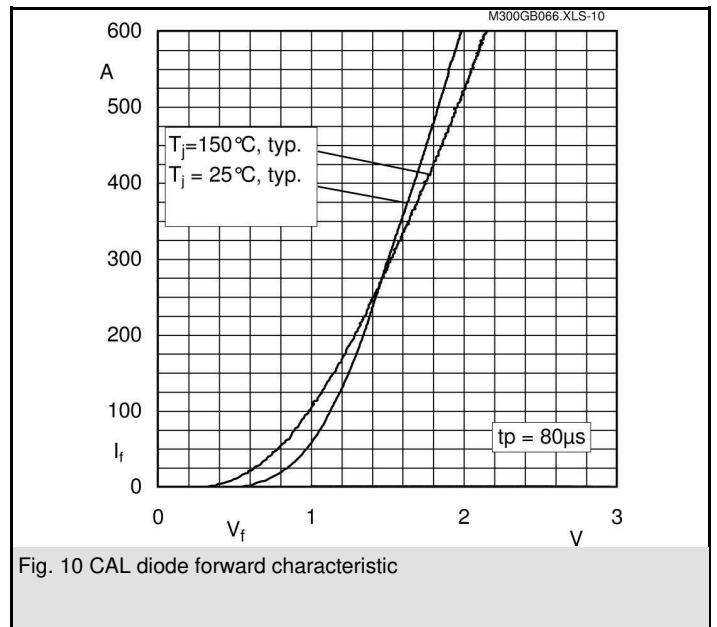
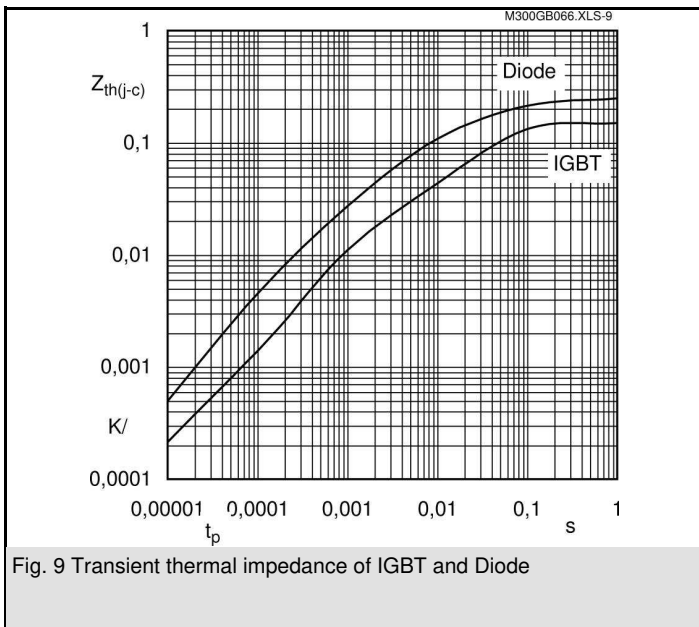
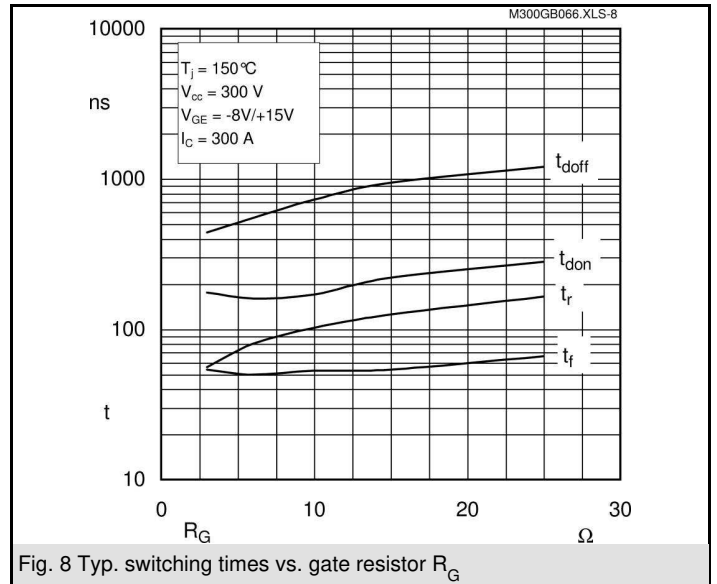
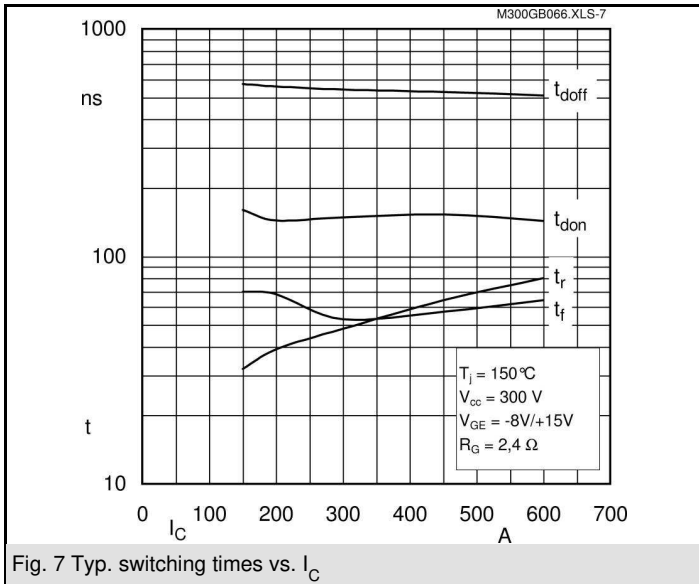

SKM 300GB066D

UL recognized, file no. E 63 532

CASED56

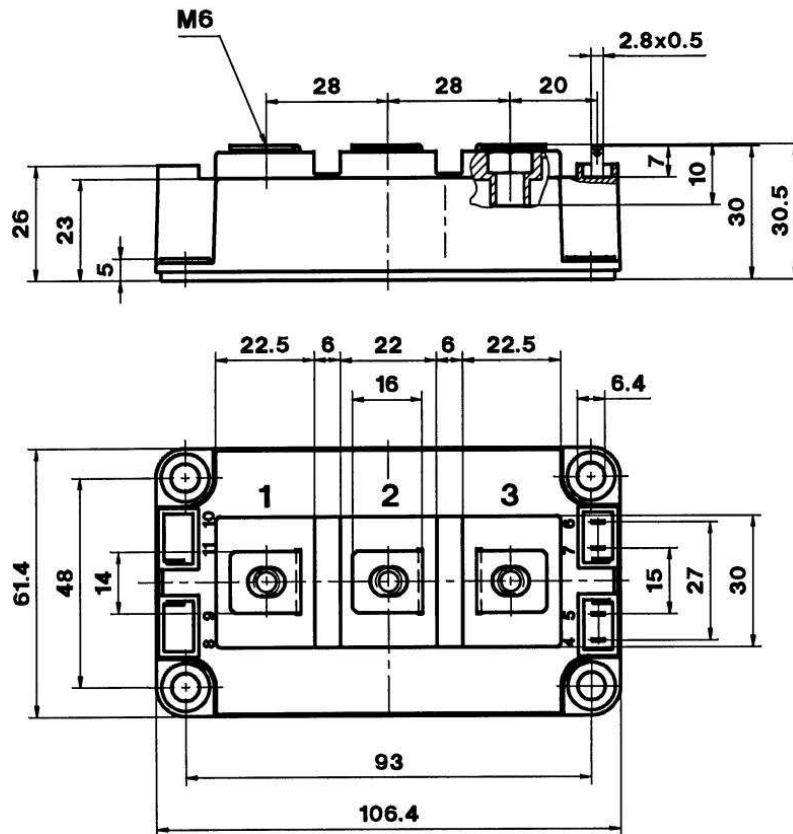

Case D 56

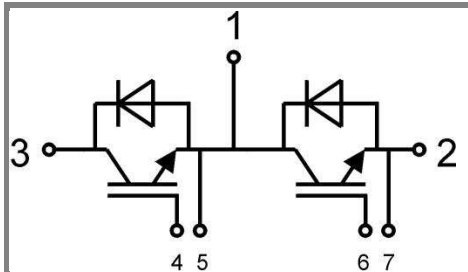

GB

Case D56