



Single Phase Diode Bridges MDQ400



Key Parameters

I_D	=	400	A
V_{RRM}	=	600-2000	V
I^2t	=	23.5	kA ² s
V_{FO}	=	0.80	V

Typical Application

- Inversion welder, current charging DC power supply
- Excitation source for DC motor, input rectifying of switching power supply
- Charging of soft starting capacitor, electric towage and auxiliary current
- DC power supply of appliance and device, input rectifying power supply of PWM frequency transformer

MAXIMUM ALLOWABLE RATINGS

Symbols and parameters		Maximum Limits	Unit
I_D	Direct output current	400	A
V_{RRM}	Max. repetitive peak reverse blocking voltage	600-2000	V
I_{RRM}	Maximum repetitive peak reverse current	10	mA
I_{FSM}	Surge peak forward current	2.5	kA
I^2t	Safety factor	22.1	kA ² s
V_{FO}	Threshold voltage	0.80	V
r_F	Slope resistance	3.8	mΩ
V_{FM}	Peak on-state voltage	1.47	V
$R_{th(j-c)}$	Thermal resistance, node to shell	0.15	°C/W
$R_{th(c-h)}$	Thermal resistance, shell to powder	0.10	°C/W

V_{isol}	Isolation voltage	2500	V
F_M	Mounting torque	4-6	mN
T_{stg}	Stored temperature	-40...125	°C
W	Weight	1170	g

DIMENSIONS

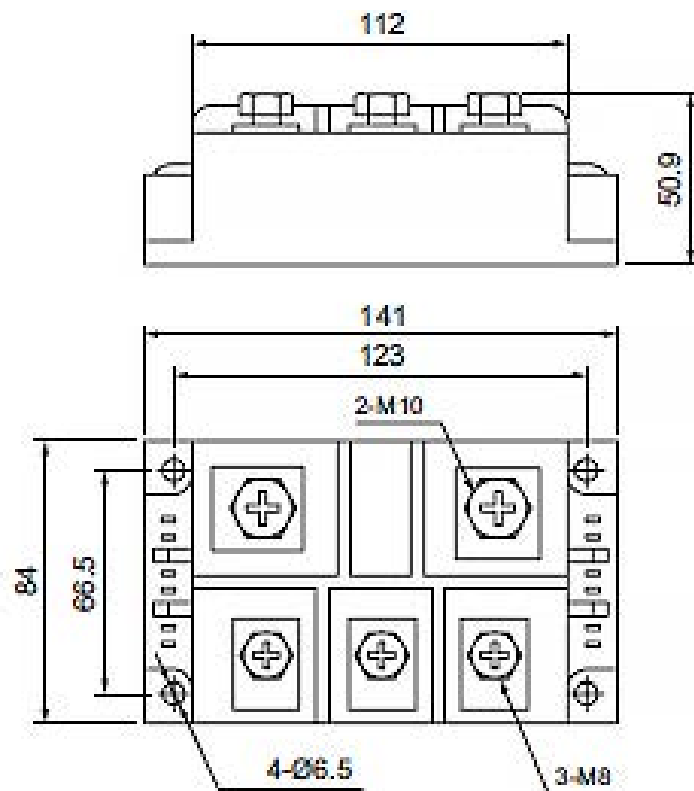

TOPOLOGY OF INTERNAL CONNECTION

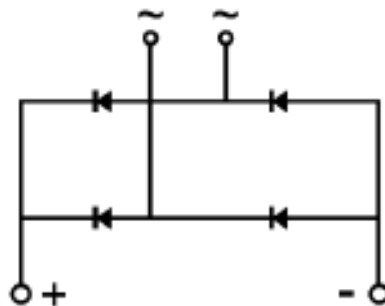

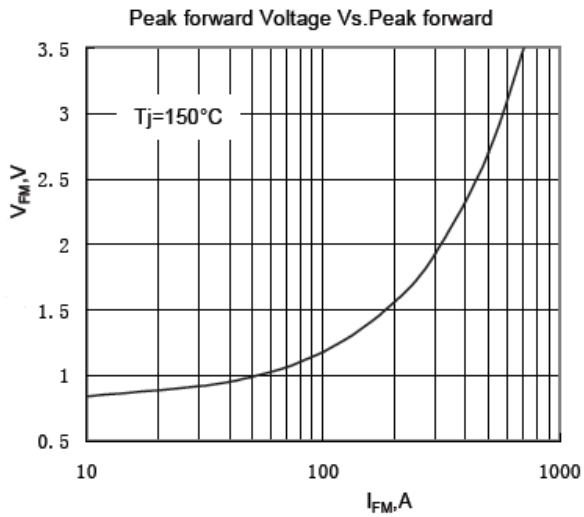

Fig.1

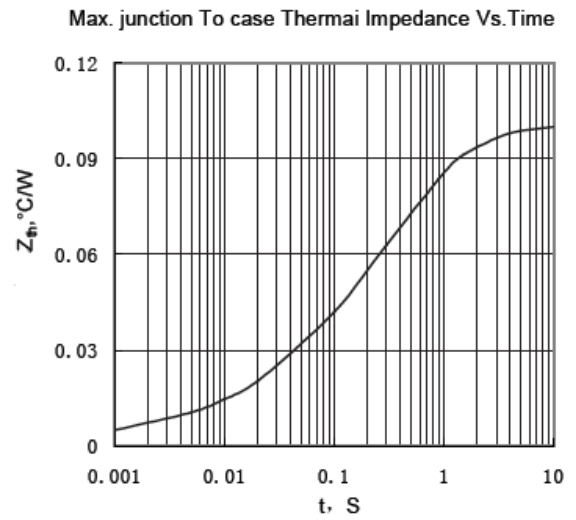

Fig.2

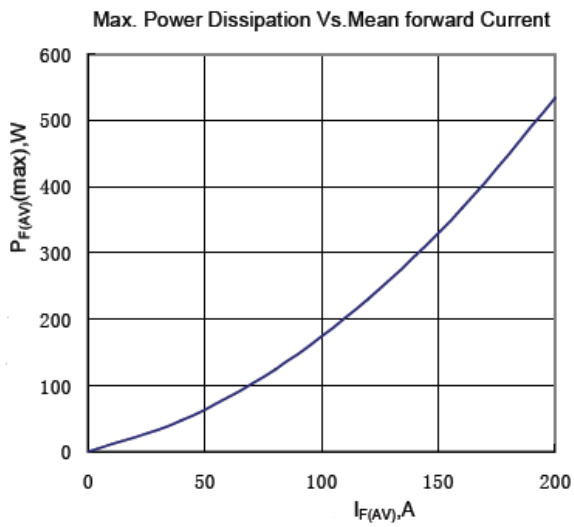

Fig.3

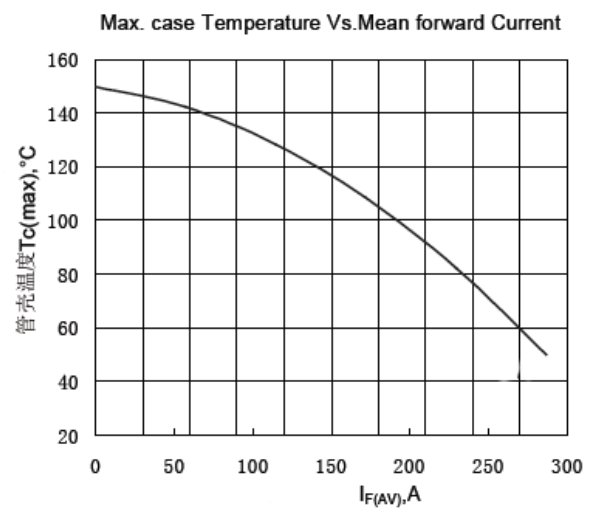

Fig.4

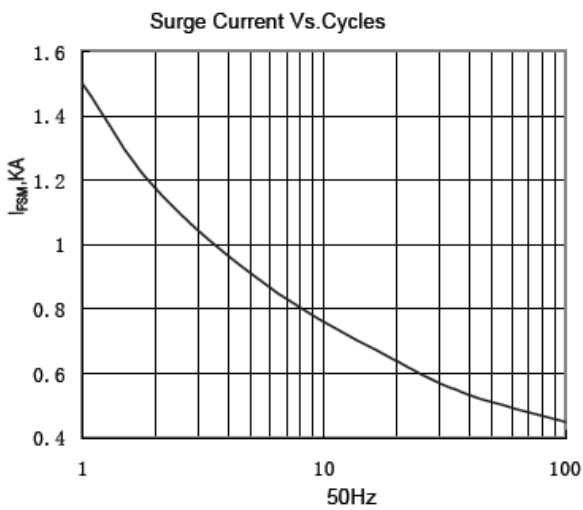

Fig.5

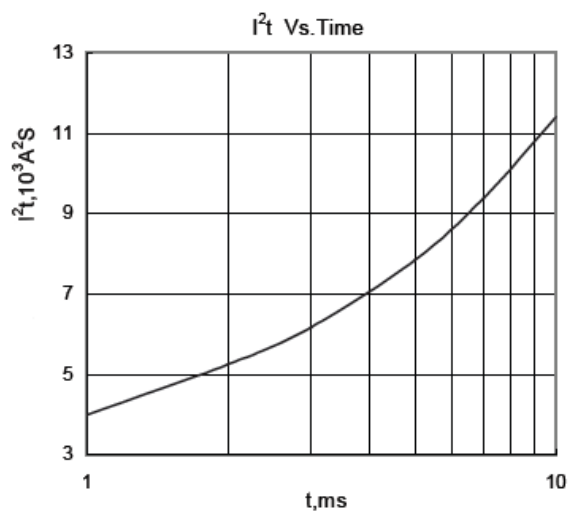

Fig.6