

ELECTRICAL PARAMETERS**Voltage ratings**

Voltage class	U_{RRM}	U_{RSM}	I_{RRM}
	V	V	mA
04	400	500	20
06	600	700	
08	800	900	
10	1000	1100	
12	1200	1300	
14	1400	1500	
16	1600	1700	

dU/dt group codes

Group code	du/dt
	V/ μ s
0	no specified value
5	320
6	500

Electrical properties

Parameter		Unit	Test conditions	Value
Average on-state current	$I_{T(AV)}$	A		106
Case temperature	T_C	°C		85
RMS on-state current	$I_{T(RMS)}$	A		166
Surge current	I_{TSM}	A	$T_j=125^\circ\text{C}$, $U_R=0,8U_{RRM}$, $t_p=10\text{ms}$	2250
I^2t – value	I^2t	kA^2s		25
On-state voltage max.	U_{TM}	V	$T_j=25^\circ\text{C}$, $I_{TM}=300\text{A}$	1,65
Threshold voltage	$U_{T(TO)}$	V		0,9
Slope resistance	r_T	$\text{m}\Omega$		2,0
Latching current	I_L	mA	$T_j=25^\circ\text{C}$, $U_D=12\text{V}$	600
Holding current	I_H	mA	$T_j=25^\circ\text{C}$, $U_D=12\text{V}$	250
Circuit commutated turn-off time (typical)	t_q	μs	$T_j=125^\circ\text{C}$, $I_{TM}=150\text{A}$, $di_R/dt=12,5\text{A}/\mu\text{s}$, $du/dt=20\text{V}/\mu\text{s}$, $U_D=0,67U_{DRM}$, $U_{RM}=100\text{V}$	100
Turn-On time (typical)	t_{gt}	μs	$I_{TM}=100\text{A}$, $U_{DM}=100\text{V}$	10
Rate of rise of on-state current-repetitive	di/dt	$\text{A}/\mu\text{s}$	$T_j=125^\circ\text{C}$, $I_{TM}=3I_{T(AV)}$, $U_D=0,67U_{DRM}$, $f=50\text{Hz}$, $I_{GM}=1\text{A}$, $di_G/dt=1\text{A}/\mu\text{s}$	100
Critical rate of raise of off-state voltage	du/dt	$\text{V}/\mu\text{s}$	$T_j=125^\circ\text{C}$, $U_D=0,67U_{DRM}$,	320
Gate current to trigger	I_{GT}	mA	$T_j=25^\circ\text{C}$, $U_D=12\text{V}$	100
Gate voltage to trigger	U_{GT}	V	$T_j=25^\circ\text{C}$, $U_D=12\text{V}$	3
RMS isolation voltage	U_{isol}	V	1s, circuit to base, all terminals shorted	3000

Thermal properties

Parameter		Unit	Test conditions	Value
Thermal resistance, junction to case per thyristor/module	R_{thJC}	°C/W	DC	0,28/0,14
Thermal resistance, case to heatsink per thyristor/module	R_{thCh}	°C/W		0,20/0,10
Operating junction temperature	$T_{jmin} \dots T_{jmax}$	°C		-40...+125
Storage temperature	T_{stg}	°C		-40...+125

Mechanical properties

Parameter		Unit	Value
Mounting torque	M1	Nm	5,00 ±15%
Terminal connection torque (M5)	M2	Nm	3,00 ±15%
Weight	M	g	95

Cofigurations

MTC

Terminal number:

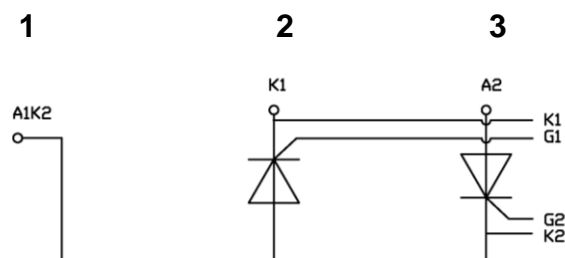

Package details

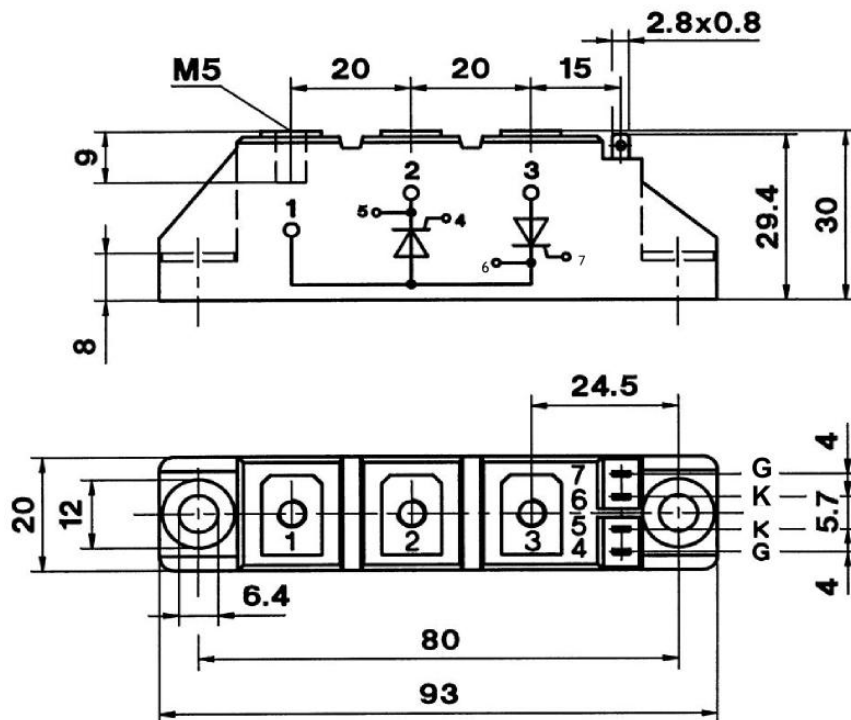

For further package information, please contact Sales & Marketing Department. All dimensions in mm, unless stated otherwise.
Do not scale.

CHARACTERISTICS

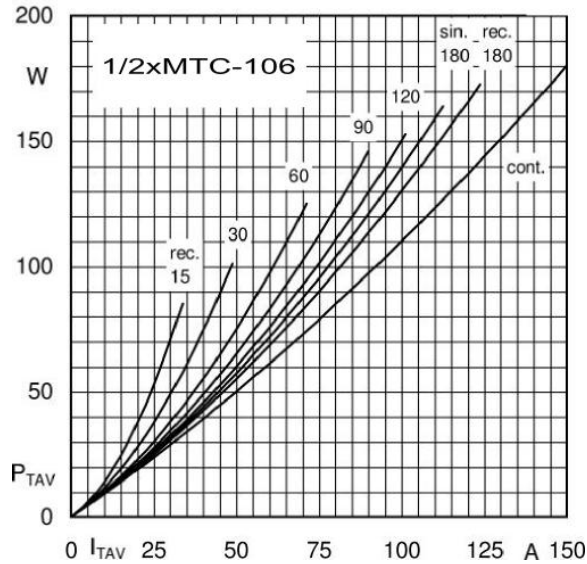

Power loss characteristics

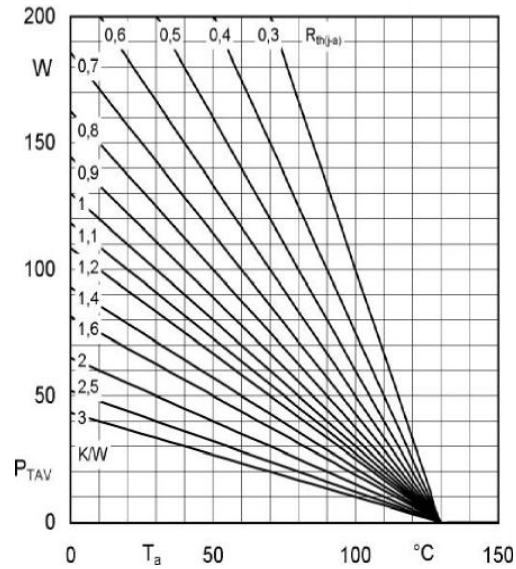

Power loss per diode vs ambient temperature

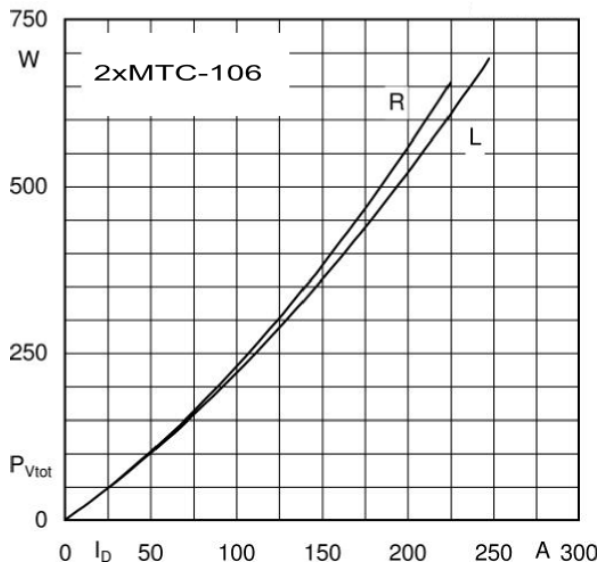

Power loss characteristics of two modules

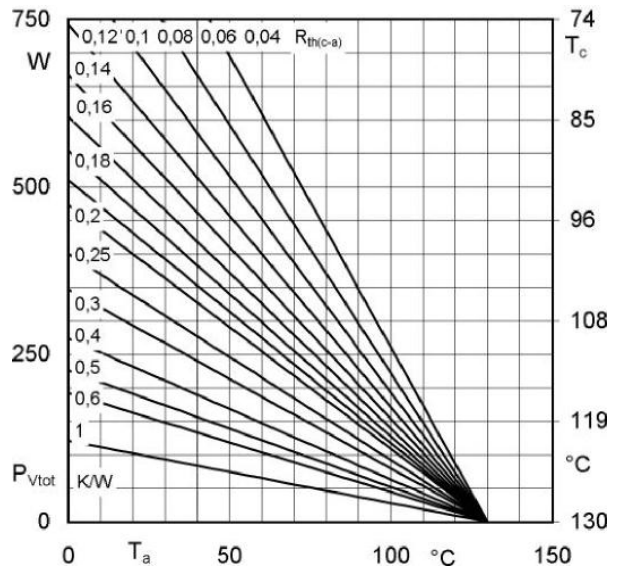

Power loss of two module vs case temperature

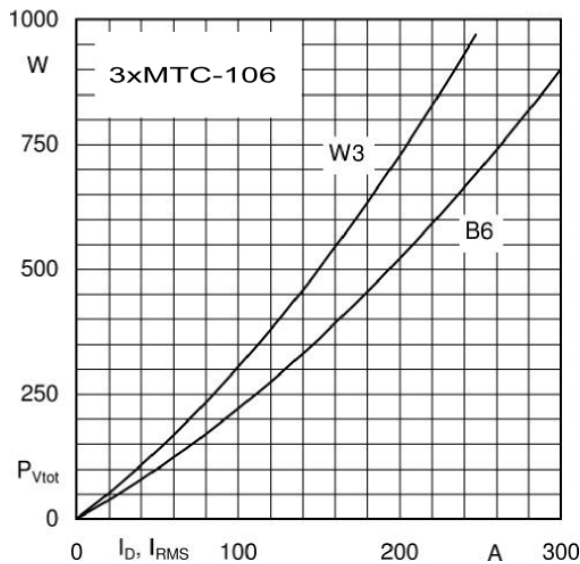

Power loss characteristics of three module

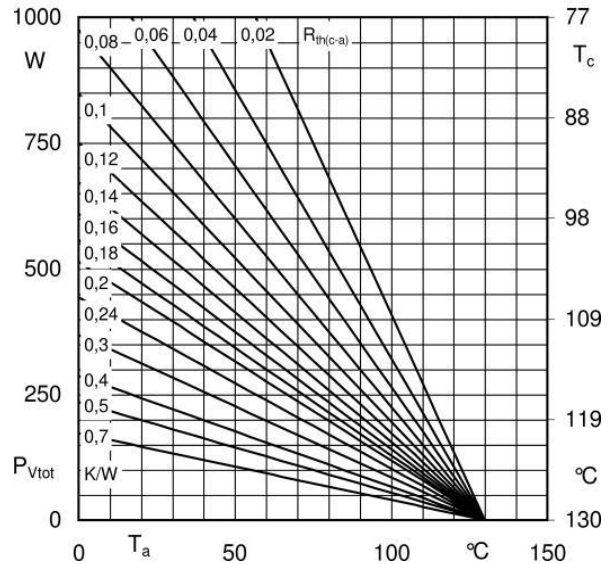

Power loss of three modules vs case temperature

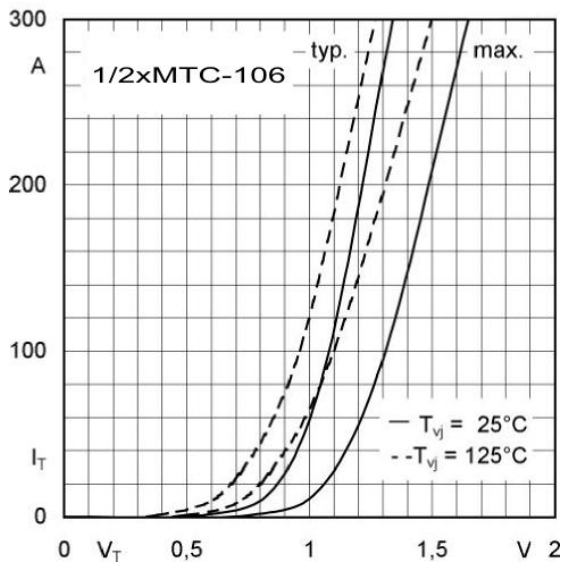

Forward characteristic

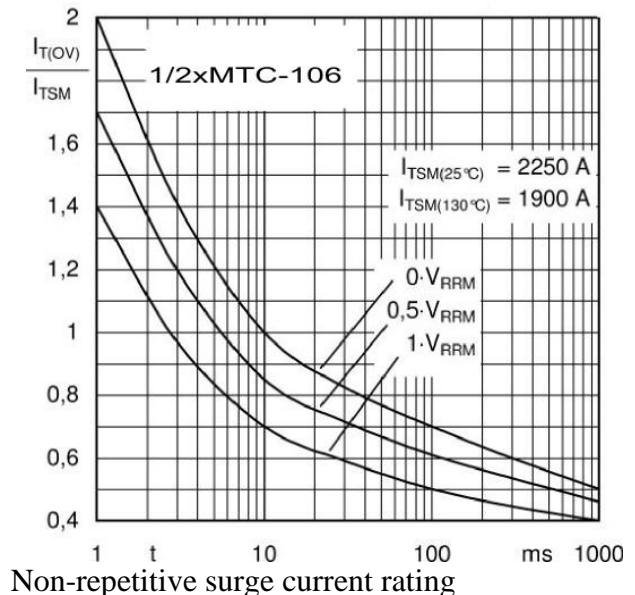

Non-repetitive surge current rating

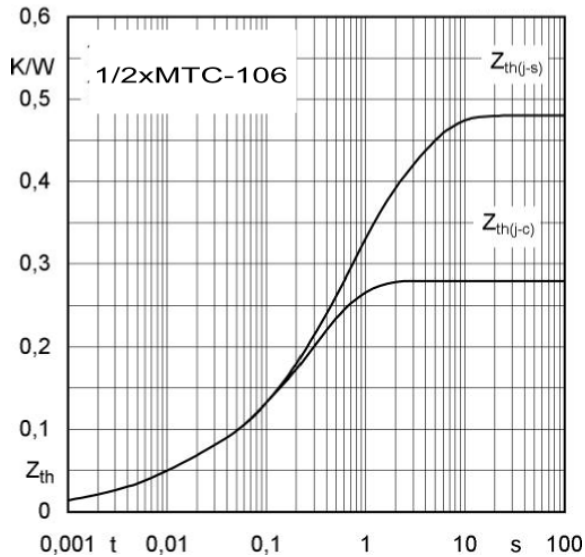

Transient thermal impedance

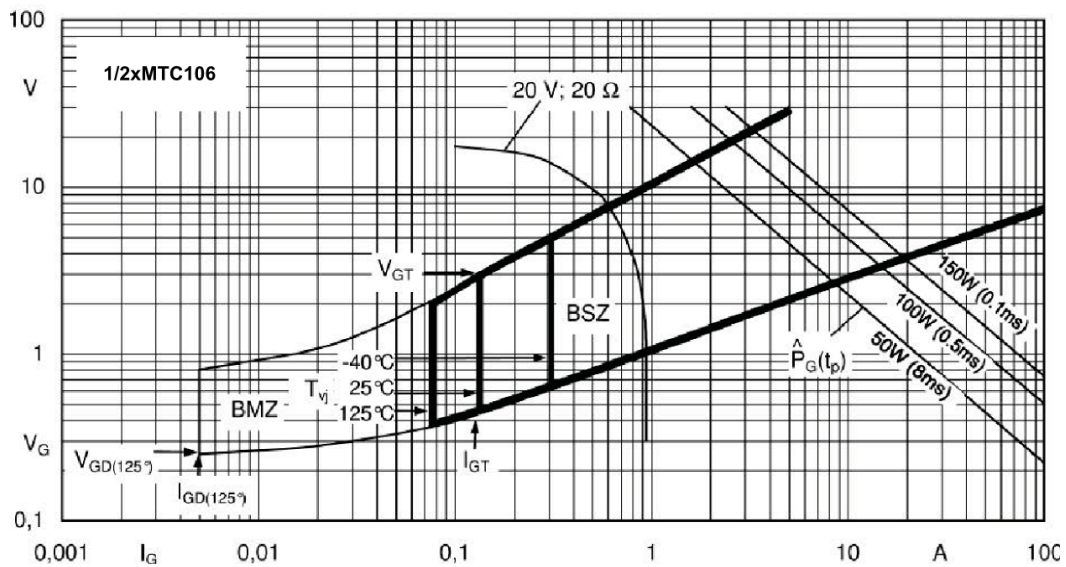

Gate trigger characteristic