

Diodes type D42 are designed for use in power electronic circuits and equipment under normal operating conditions.

KEY PARAMETERS

U_{RRM}	up to 1400 V
$I_{F(AV)}$	70 A
I_{FSM}	950 A

FEATURES

- high current capabilities
- high surge current capabilities
- low thermal impedance
- tested according to IEC standards
- compact size and small weight

APPLICATION

- High Voltage Power Supplies
- Motor Control
- Battery Chargers
- Free Wheeling Diode
- Resistance Welding

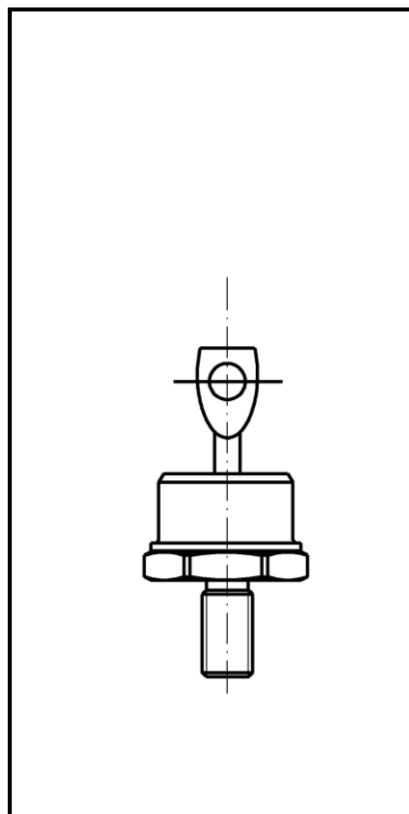

Outline type code: DO-5

See package details for further information

ORDERING INFORMATION

When ordering please refer to device code builder presented below.

Please use the complete part number when ordering, quote or in any future correspondence relating to your order.

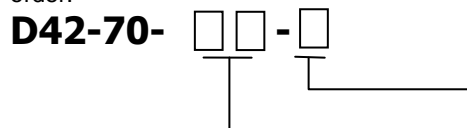

Polarization code: N or R

voltage class (hundreds of volts)

D42-70

Diode

KKD4270, April 2004 version

ELECTRICAL PARAMETERS

Voltage ratings

Voltage class	U_{RRM}	U_{RSM}	I_{RRM}
	V	V	mA
02	200	300	10
04	400	500	
06	600	700	
08	800	900	
10	1000	1100	
12	1200	1300	
14	1400	1500	

Electrical properties

Parameter	Unit	Test conditions	Value
Average forward current @ case temperature	$I_{F(AV)}$	A	70
	T_c	°C	100
RMS forward current	$I_{F(RMS)}$	A	110
Surge current	I_{FSM}	A	$T_j=T_{jmax}, U_R=0,8U_{RRM}, t_p=10ms$
I^2t – value	I^2t	kA ² s	4,5
Forward voltage drop max.	U_{FM}	V	$T_j=25^\circ C, I_{FM}=200A$
Threshold voltage	$U_{F(T0)}$	V	0,8
Slope resistance	r_F	mΩ	2,3

Thermal properties

Parameter	Unit	Test conditions	Value
Thermal resistance, junction to case	R_{thJC}	°C/W	DC
Operating junction temperature	$T_{jmin}...T_{jmax}$	°C	-25...+150
Storage temperature	T_{stg}	°C	-25...+150

Mechanical properties

Parameter	Unit	Value
Mounting torque	M	Nm
Weight	m	g

D42-70

Diode

KKD4270, April 2004 version

Package details

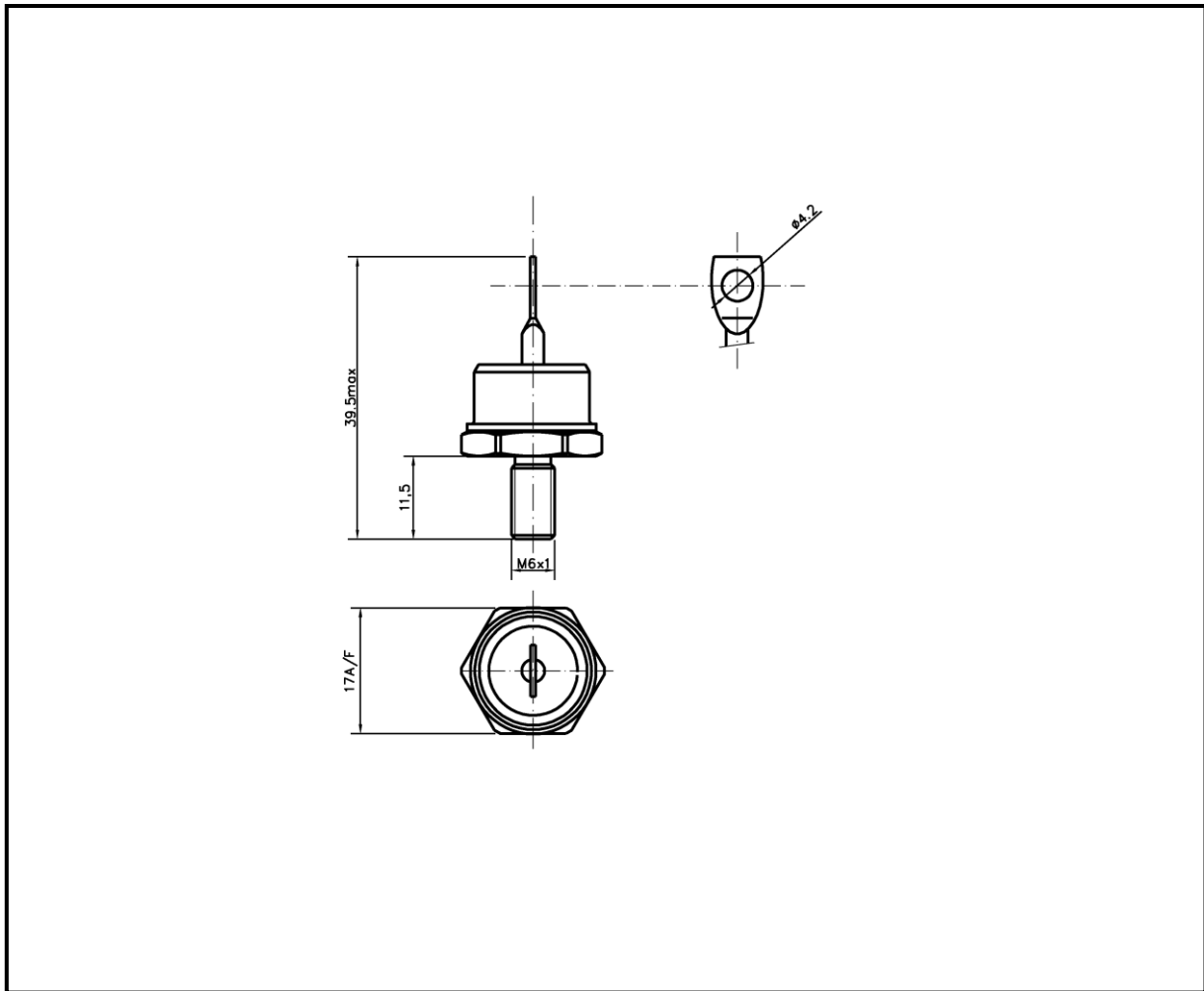

For further package information, please contact Sales & Marketing Department. All dimensions in mm, unless stated otherwise.
Do not scale.

D42-70

Diode

KKD4270, April 2004 version

CHARACTERISTICS

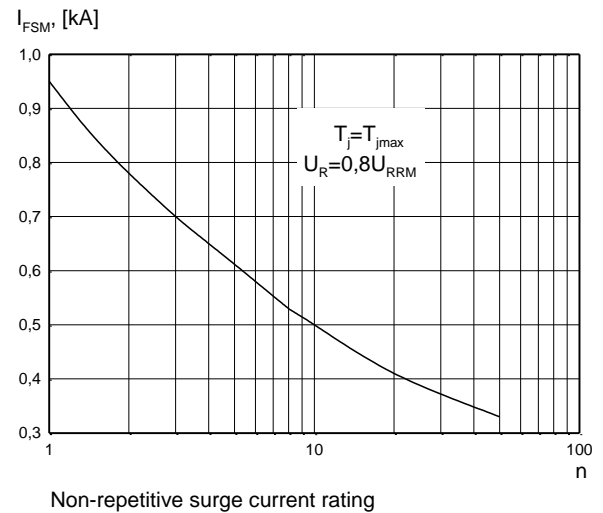
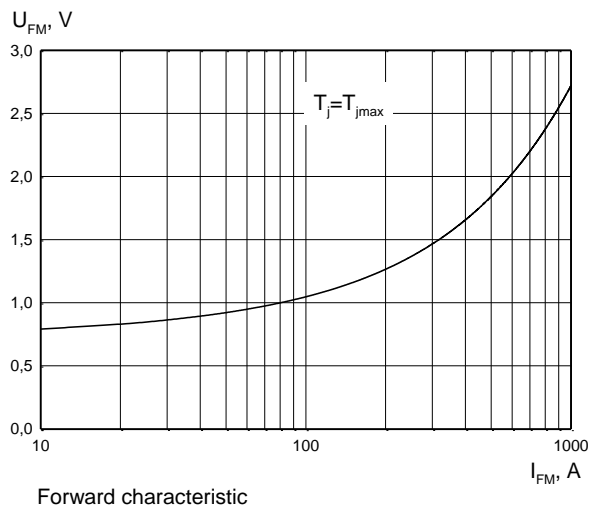
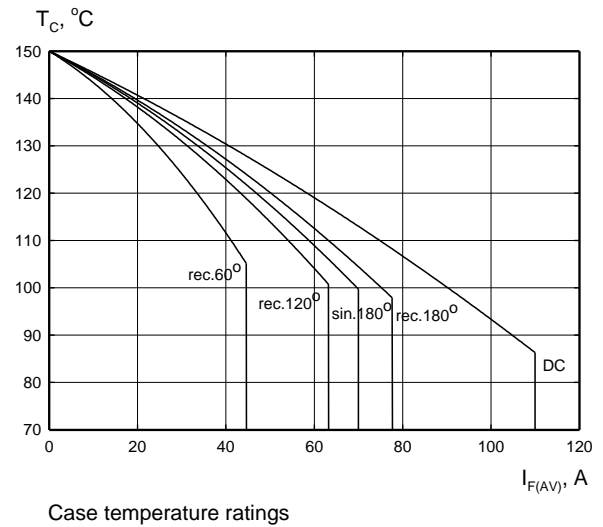
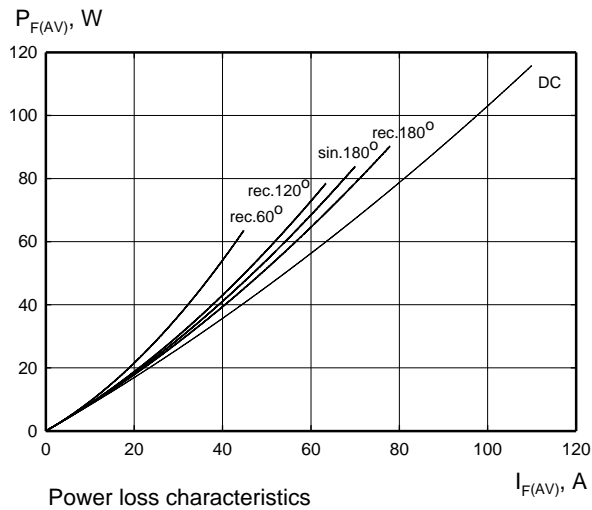

D42-70

Diode

KKD4270, April 2004 version

