

Phase Control Thyristor Types N0676YS120 to N0676YS180

Absolute Maximum Ratings

	VOLTAGE RATINGS	MAXIMUM LIMITS	UNITS
V_{DRM}	Repetitive peak off-state voltage, (note 1)	1200-1800	V
V_{DSM}	Non-repetitive peak off-state voltage, (note 1)	1200-1800	V
V_{RRM}	Repetitive peak reverse voltage, (note 1)	1200-1800	V
V_{RSM}	Non-repetitive peak reverse voltage, (note 1)	1300-1900	V

	OTHER RATINGS	MAXIMUM LIMITS	UNITS
$I_{T(AV)}$	Mean on-state current, $T_{sink}=55^{\circ}C$, (note 2)	676	A
$I_{T(AV)}$	Mean on-state current. $T_{sink}=85^{\circ}C$, (note 2)	456	A
$I_{T(AV)}$	Mean on-state current. $T_{sink}=85^{\circ}C$, (note 3)	270	A
$I_{T(RMS)}$	Nominal RMS on-state current, $25^{\circ}C$, (note 2)	1346	A
$I_{T(d.c.)}$	D.C. on-state current, $25^{\circ}C$, (note 4)	1138	A
I_{TSM}	Peak non-repetitive surge $t_p=10ms$, $V_{RM}=0.6V_{RRM}$, (note 5)	7500	A
I_{TSM2}	Peak non-repetitive surge $t_p=10ms$, $V_{RM}\leq 10V$, (note 5)	8300	A
I^2t	I^2t capacity for fusing $t_p=10ms$, $V_{RM}=0.6V_{RRM}$, (note 5)	281×10^3	A^2s
I^2t	I^2t capacity for fusing $t_p=10ms$, $V_{RM}\leq 10V$, (note 5)	345×10^3	A^2s
di_T/dt	Maximum rate of rise of on-state current (repetitive), (Note 6)	500	$A/\mu s$
	Maximum rate of rise of on-state current (non-repetitive), (Note 6)	1000	$A/\mu s$
V_{RGM}	Peak reverse gate voltage	5	V
$P_{G(AV)}$	Mean forward gate power	2	W
P_{GM}	Peak forward gate power	30	W
V_{GD}	Non-trigger gate voltage, (Note 7)	0.25	V
T_{HS}	Operating temperature range	-40 to +125	$^{\circ}C$
T_{stg}	Storage temperature range	-40 to +150	$^{\circ}C$

Notes:-

- 1) De-rating factor of 0.13% per $^{\circ}C$ is applicable for T_j below $25^{\circ}C$.
- 2) Double side cooled, single phase; 50Hz, 180° half-sinewave.
- 3) Single side cooled, single phase; 50Hz, 180° half-sinewave.
- 4) Double side cooled.
- 5) Half-sinewave, $125^{\circ}C$ T_j initial.
- 6) $V_D=67\% V_{DRM}$, $I_{TM}=1000A$, $I_{FG}=2A$, $t_r\leq 0.5\mu s$, $T_{case}=125^{\circ}C$.
- 7) Rated V_{DRM} .

Characteristics

	PARAMETER	MIN.	TYP.	MAX.	TEST CONDITIONS (Note 1)	UNITS
V_{TM}	Maximum peak on-state voltage	-	-	2.0	$I_{TM}=1550A$	V
V_0	Threshold voltage	-	-	1.09		V
r_s	Slope resistance	-	-	0.587		m Ω
dv/dt	Critical rate of rise of off-state voltage	1000	-	-	$V_D=80\% V_{DRM}$	V/ μ s
I_{DRM}	Peak off-state current	-	-	40	Rated V_{DRM}	mA
I_{RRM}	Peak reverse current	-	-	40	Rated V_{RRM}	mA
V_{GT}	Gate trigger voltage	-	-	3.0	$T_j=25^\circ C$	V
I_{GT}	Gate trigger current	-	-	150	$T_j=25^\circ C$. $V_D=10V$, $I_T=3A$	mA
I_H	Holding current	-	-	500	$T_j=25^\circ C$	mA
R_θ	Thermal resistance, junction to heatsink	-	-	0.05	Double side cooled	K/W
		-	-	0.1	Single side cooled	K/W
F	Mounting force	5.3	-	10		kN
W_t	Weight	-	90	-		g

Notes:-

1) Unless otherwise indicated $T_j=125^\circ C$.

Notes on Ratings and Characteristics

1.0 Voltage Grade Table

Voltage Grade 'H'	V _{DRM} V _{DSM} V _{RRM} V	V _{RSM} V	V _D V _R DC V
12	1200	1400	810
14	1400	1500	930
16	1600	1700	1040
18	1800	1900	1150

2.0 Extension of Voltage Grades

This report is applicable to other and higher voltage grades when supply has been agreed by Sales/Production.

3.0 De-rating Factor

A blocking voltage de-rating factor of 0.13%/°C is applicable to this device for T_j below 25°C.

4.0 Repetitive dv/dt

Standard dv/dt is 1000V/μs.

5.0 Computer Modelling Parameters

5.1 Device Dissipation Calculations

$$I_{AV} = \frac{-V_0 + \sqrt{V_0^2 + 4 \cdot ff^2 \cdot r_s \cdot W_{AV}}}{2 \cdot ff^2 \cdot r_s} \quad \text{and:} \quad W_{AV} = \frac{\Delta T}{R_{th}}$$

$$\Delta T = T_{j\max} - T_{Hs}$$

Where V₀=1.09V, r_s=0.587mΩ,

R_{th} = Supplementary thermal impedance, see table below.

ff = Form factor, see table below.

Supplementary Thermal Impedance

Conduction Angle	30°	60°	90°	120°	180°	270°	d.c.
Square wave Double Side Cooled	0.071	0.069	0.065	0.061	0.057	0.053	0.05
Square wave Single Side Cooled	0.12	0.119	0.115	0.111	0.107	0.103	0.1
Sine wave Double Side Cooled	0.053	0.052	0.0516	0.0513	0.0505		
Sine wave Single Side Cooled	0.103	0.102	0.1017	0.1013	0.1005		

Form Factors

Conduction Angle	30°	60°	90°	120°	180°	270°	d.c.
Square wave	3.46	2.45	2	1.73	1.41	1.15	1
Sine wave	3.98	2.78	2.22	1.88	1.57		

5.2 Calculating V_T using ABCD Coefficients

The on-state characteristic I_T vs. V_T , on page 7 is represented in two ways;

- (i) the well established V_o and r_s tangent used for rating purposes and
- (ii) a set of constants A, B, C, D, forming the coefficients of the representative equation for V_T in terms of I_T given below:

$$V_T = A + B \cdot \ln(I_T) + C \cdot I_T + D \cdot \sqrt{I_T}$$

The constants, derived by curve fitting software, are given below for both hot and cold characteristics. The resulting values for V_T agree with the true device characteristic over a current range, which is limited to that plotted.

25°C Coefficients		125°C Coefficients	
A	1.175567	A	1.0538816
B	-0.0883931	B	-0.1096815
C	2.17593×10^{-4}	C	2.5239×10^{-4}
D	0.02521394	D	0.03456018

5.3 D.C. Thermal Impedance Calculation

$$r_t = \sum_{p=1}^{p=n} r_p \cdot \left(1 - e^{-\frac{t}{\tau_p}} \right)$$

Where $p = 1$ to n , n is the number of terms in the series and:

- t = Duration of heating pulse in seconds.
- r_t = Thermal resistance at time t .
- r_p = Amplitude of p_{th} term.
- τ_p = Time Constant of r_{th} term.

D.C. Double Side Cooled				
Term	1	2	3	4
r_p	0.12000552	0.01609235	8.812673×10^{-3}	3.659765×10^{-3}
τ_p	0.3391689	0.09405764	0.12195269	2.196197×10^{-3}

D.C. Single Side Cooled					
Term	1	2	3	4	5
r_p	0.06157697	8.431182×10^{-3}	0.01031315	0.01613806	5.181088×10^{-3}
τ_p	2.136132	1.212898	0.1512408	0.04244	2.889595×10^{-3}

Curves

Figure 1 - On-state current vs. Power dissipation – Double Side Cooled (Sine wave)

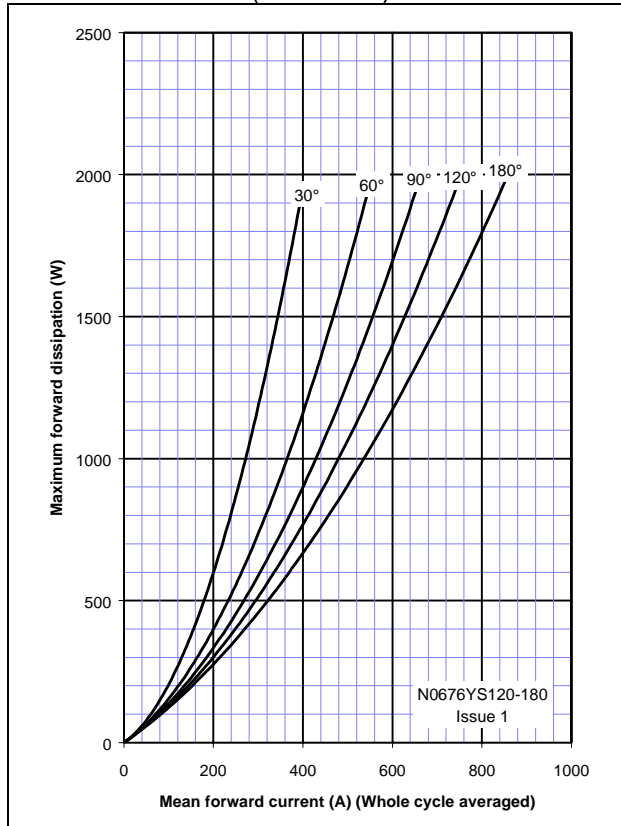

Figure 2 - On-state current vs. Heatsink temperature - Double Side Cooled (Sine wave)

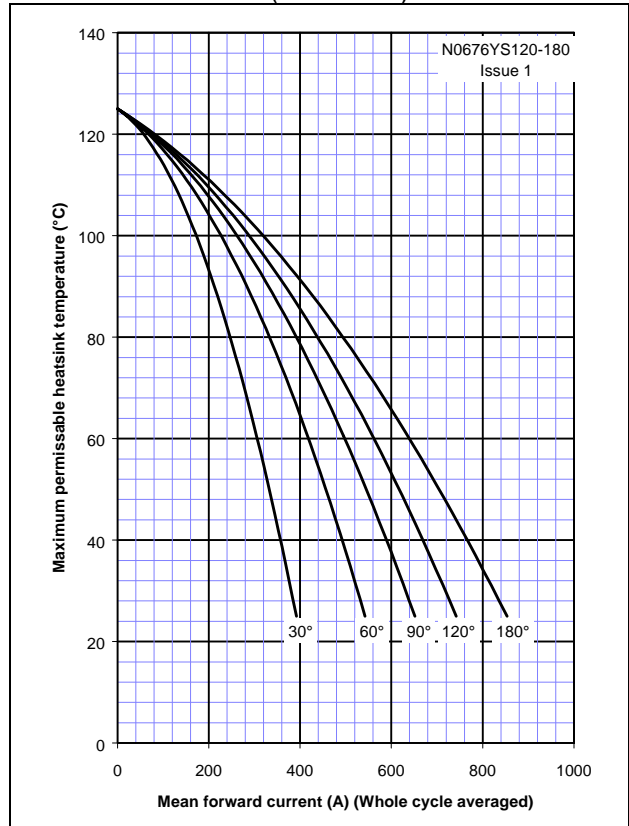

Figure 3 - On-state current vs. Power dissipation – Double Side Cooled (Square wave)

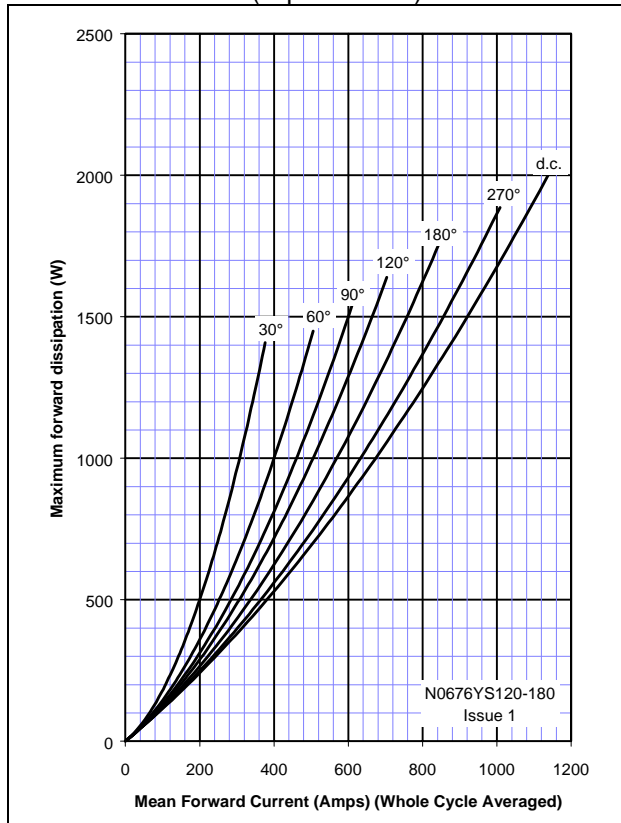

Figure 4 - On-state current vs. Heatsink temperature - Double Side Cooled (Square wave)

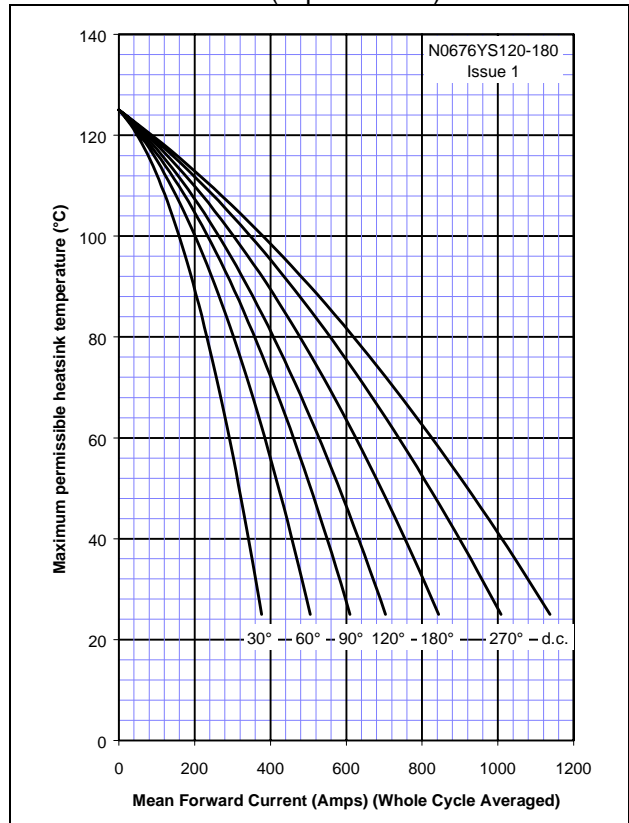

Figure 5 - On-state current vs. Power dissipation – Single Side Cooled (Sine wave)

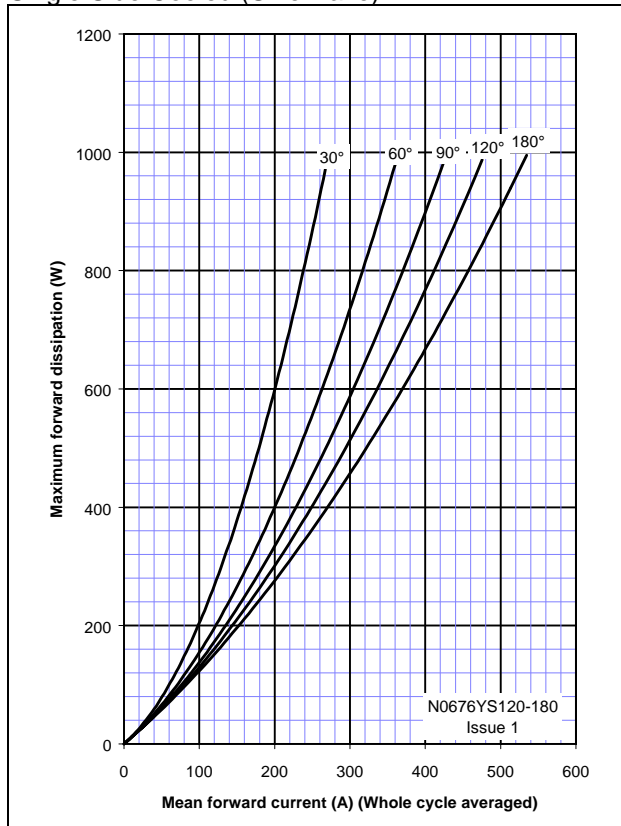

Figure 6 - On-state current vs. Heatsink temperature - Single Side Cooled (Sine wave)

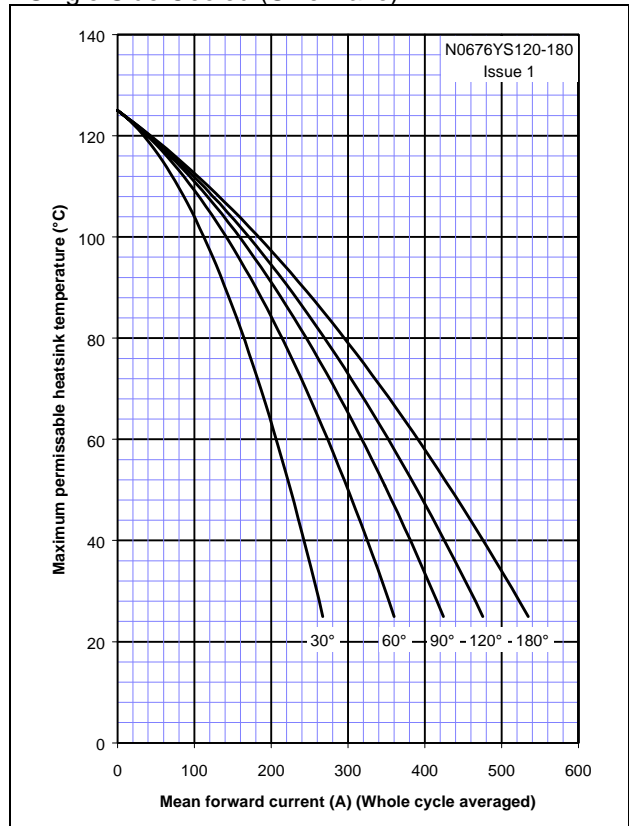

Figure 7 - On-state current vs. Power dissipation – Single Side Cooled (Square wave)

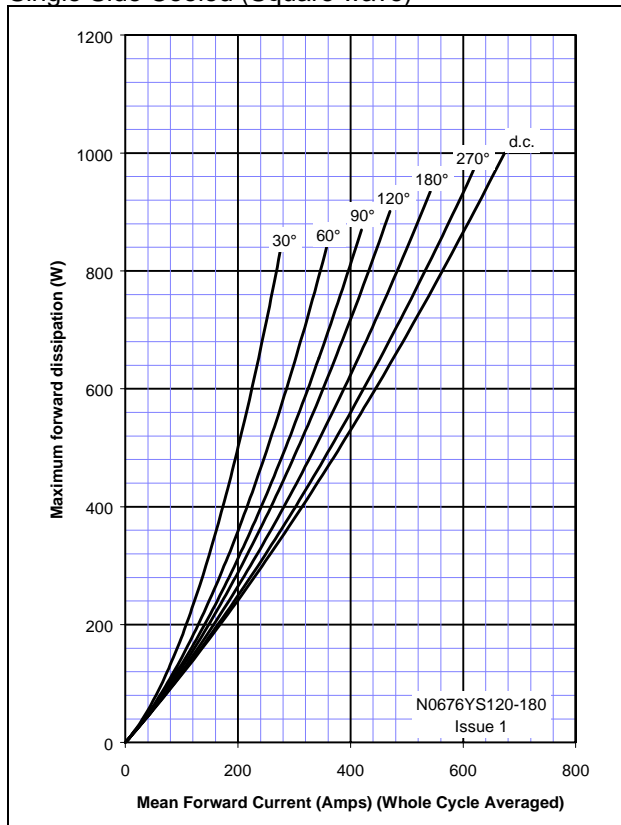

Figure 8 - On-state current vs. Heatsink temperature - Single Side Cooled (Square wave)

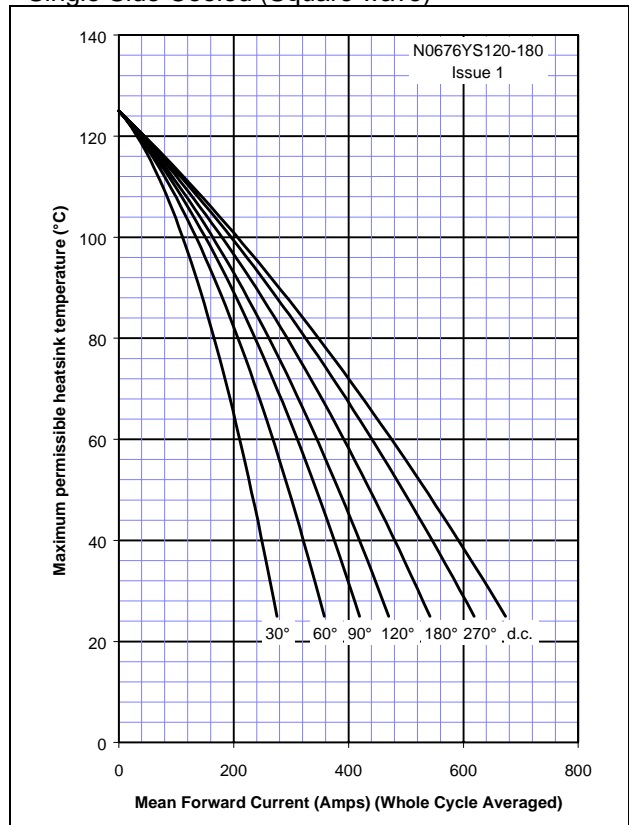

Figure 9 - On-state characteristics of Limit device

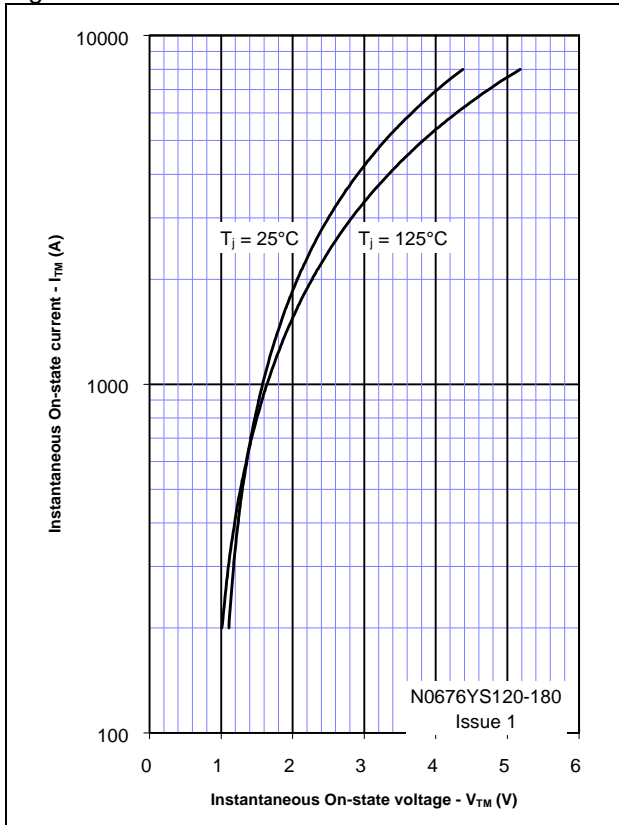

Figure 10 - Transient Thermal Impedance

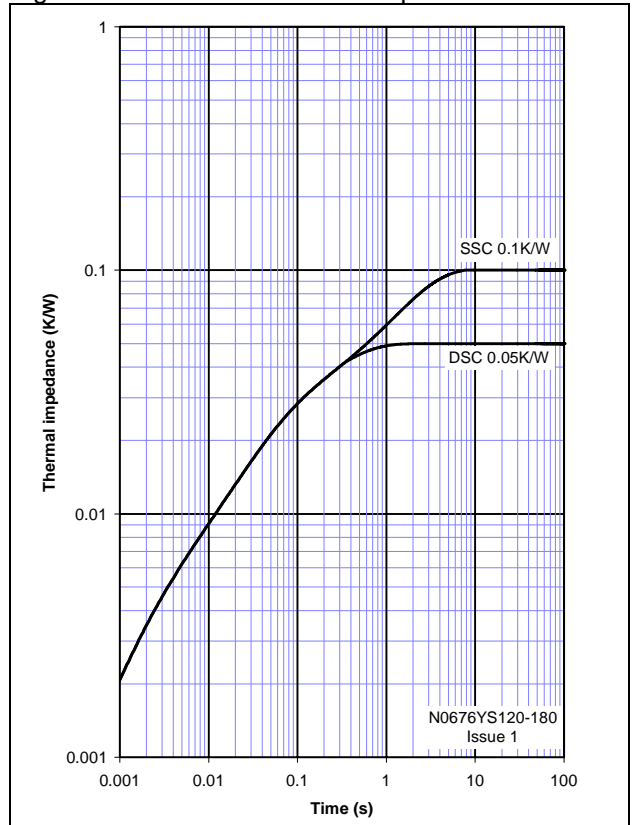

Figure 11 - Gate Characteristics - Trigger Limits

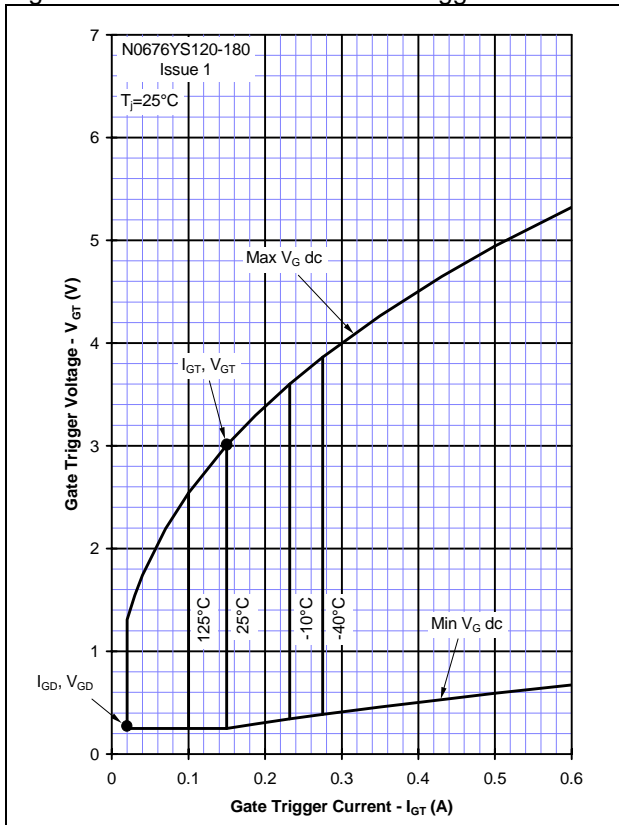

Figure 12 - Gate Characteristics - Power Curves

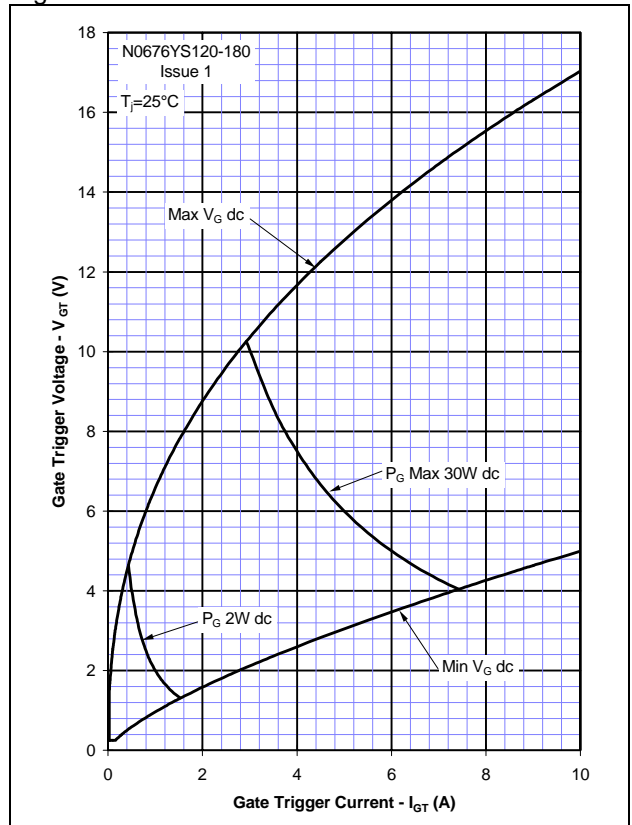
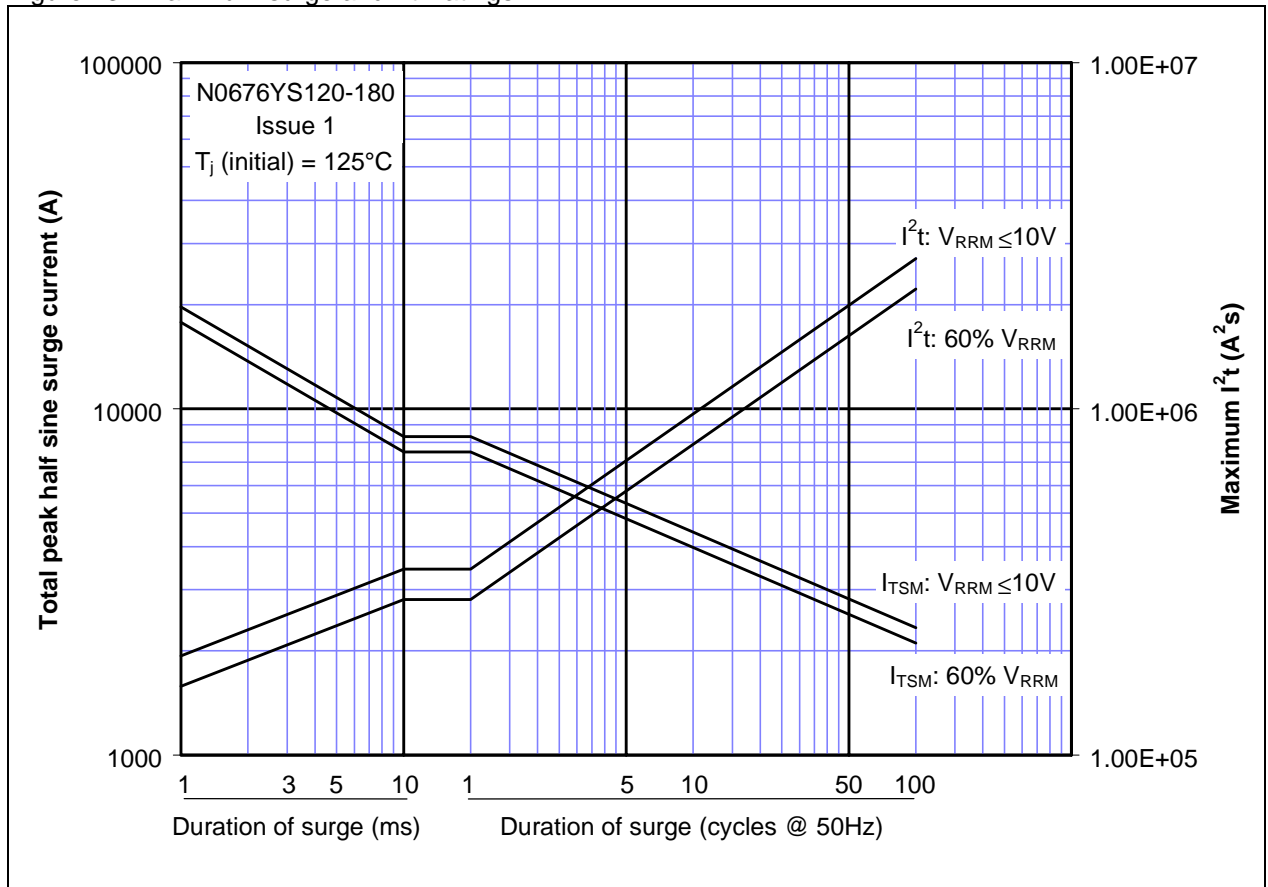
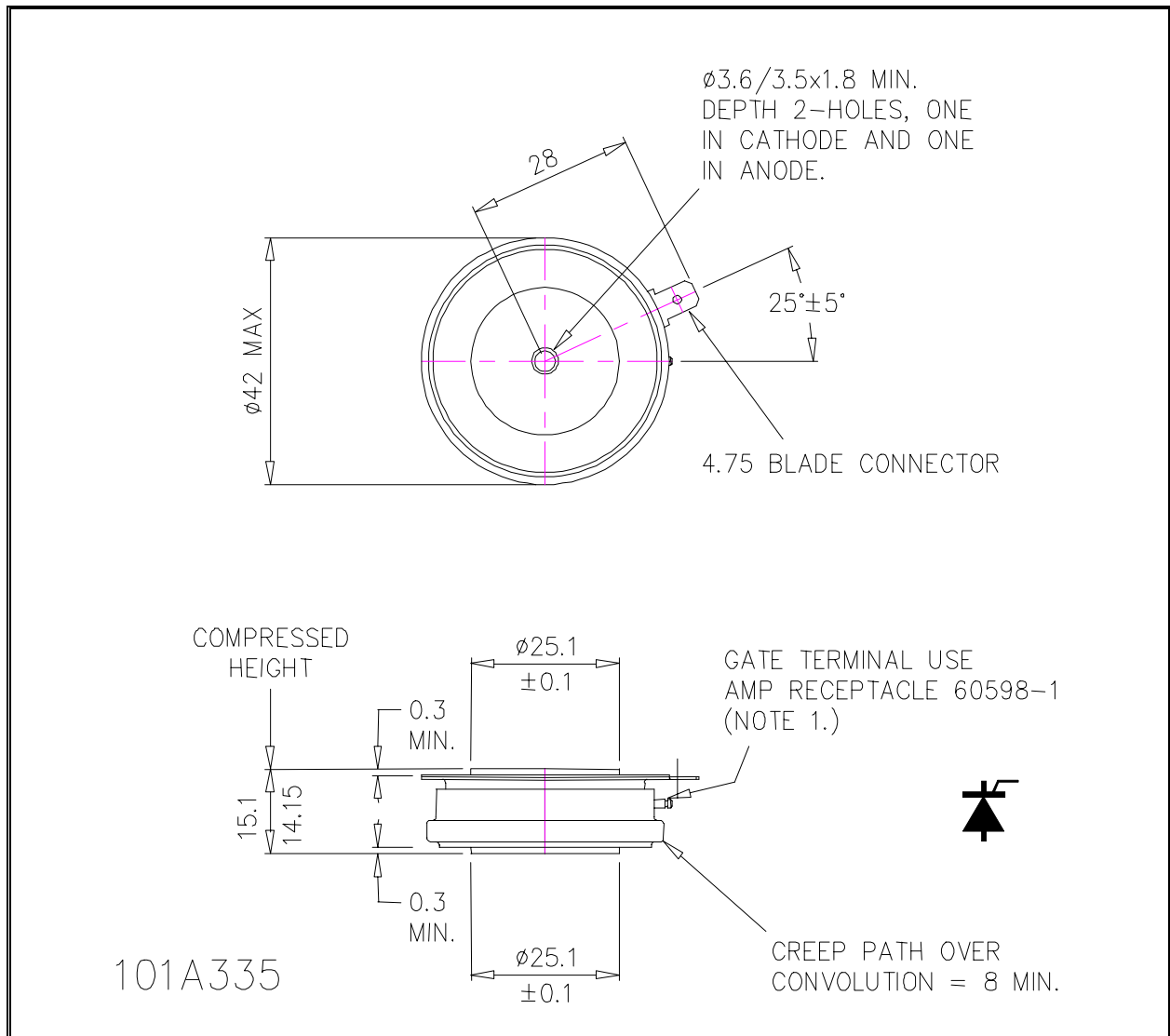

Figure 13 - Maximum surge and I^2t Ratings



Outline Drawing & Ordering Information



ORDERING INFORMATION (Please quote 10 digit code as below)

N0676	YS	◆ ◆	0
Fixed Type Code	Fixed Outline Code	Voltage Code 12-18	Fixed turn-off time code

Typical order code: N0676YS140 – 1400V V_{DRM} , V_{RRM} , 1000V/ μ s dv/dt, 15.1mm clamp height capsule.

WESTCODE

Internet: <http://www.westcode.com>

UK: Westcode Semiconductors Ltd.
 P.O. Box 57, Chippenham, Wiltshire, England. SN15 1JL.
 Tel: +44 (0) 1249 444524 Fax: +44 (0) 1249 659448
 E-Mail: WSL.sales@westcode.com

USA: Westcode Semiconductors Inc.
 3270 Cherry Avenue, Long Beach, California 90807
 Tel: +1 (562) 595 6971 Fax: +1 (562) 595 8182
 E-Mail: WSI.sales@westcode.com

The information contained herein is confidential and is protected by Copyright. The information may not be used or disclosed except with the written permission of and in the manner permitted by the proprietors Westcode Semiconductors Ltd. © Westcode Semiconductors Ltd.

In the interest of product improvement, Westcode reserves the right to change specifications at any time without prior notice.

Devices with a suffix code (2-letter or letter/digit/letter combination) added to their generic code are not necessarily subject to the conditions and limits contained in this report.