

Provisional Data

## Rectifier Diode

### Type W4713H#300 to W4713H#350

(Development Part No. Wx207H#300-350)

#### Absolute Maximum Ratings

	VOLTAGE RATINGS	MAXIMUM LIMITS	UNITS
$V_{RRM}$	Repetitive peak reverse voltage, (note 1)	3000-3500	V
$V_{RSM}$	Non-repetitive peak reverse voltage, (note 1)	3100-3600	V

	OTHER RATINGS	MAXIMUM LIMITS	UNITS
$I_{F(AV)M}$	Maximum average forward current, $T_{sink}=55^{\circ}C$ , (note 2)	4713	A
$I_{F(AV)M}$	Maximum average forward current. $T_{sink}=100^{\circ}C$ , (note 2)	3261	A
$I_{F(AV)M}$	Maximum average forward current. $T_{sink}=100^{\circ}C$ , (note 3)	1996	A
$I_{F(RMS)M}$	Nominal RMS forward current, $T_{sink}=25^{\circ}C$ , (note 2)	8678	A
$I_{F(d.c.)}$	D.C. forward current, $T_{sink}=25^{\circ}C$ , (note 4)	7562	A
$I_{FSM}$	Peak non-repetitive surge $t_p=10ms$ , $V_{rm}=60\%V_{RRM}$ , (note 5)	56.0	kA
$I_{FSM2}$	Peak non-repetitive surge $t_p=10ms$ , $V_{rm}\leq 10V$ , (note 5)	61.6	kA
$I^2t$	$I^2t$ capacity for fusing $t_p=10ms$ , $V_{rm}=60\%V_{RRM}$ , (note 5)	$15.7\times 10^6$	$A^2s$
$I^2t$	$I^2t$ capacity for fusing $t_p=10ms$ , $V_{rm}\leq 10V$ , (note 5)	$19.0\times 10^6$	$A^2s$
$T_{j\ op}$	Operating temperature range	-40 to +160	$^{\circ}C$
$T_{stg}$	Storage temperature range	-40 to +160	$^{\circ}C$

#### Notes:-

- 1) De-rating factor of 0.13% per  $^{\circ}C$  is applicable for  $T_j$  below  $25^{\circ}C$ .
- 2) Double side cooled, single phase; 50Hz,  $180^{\circ}$  half-sinewave.
- 3) Single side cooled, single phase; 50Hz,  $180^{\circ}$  half-sinewave.
- 4) Double side cooled.
- 5) Half-sinewave,  $160^{\circ}C$   $T_j$  initial.

**Characteristics**

	PARAMETER	MIN.	TYP.	MAX.	TEST CONDITIONS (Note 1)	UNITS
V <sub>FM</sub>	Maximum peak forward voltage	-	-	1.35 1.50	I <sub>TM</sub> =6000A I <sub>TM</sub> =8000A	V
V <sub>T0</sub>	Threshold voltage	-	-	0.807	Range 2000A – 6000A	V
r <sub>T</sub>	Slope resistance	-	-	0.09		mΩ
I <sub>RRM</sub>	Peak reverse current	-	-	150 150	Rated V <sub>RRM</sub> Rated V <sub>RRM</sub> , T <sub>j</sub> =25°C	mA
Q <sub>rr</sub>	Recovered charge	-	7500	8600	I <sub>TM</sub> =2000A, t <sub>p</sub> =2000μs, di/dt=10A/μs, V <sub>r</sub> =100V	μC
Q <sub>ra</sub>	Recovered charge, 50% chord	-	6000	-		μC
I <sub>rm</sub>	Reverse recovery current	-	250	-		A
t <sub>rr</sub>	Reverse recovery time, 50% chord	-	47	-		μs
R <sub>thJK</sub>	Thermal resistance, junction to heatsink	-	-	0.012 0.024	Double side cooled Single side cooled	K/W
F	Mounting force	36	-	44		kN
W <sub>t</sub>	Weight	-	1.2 1.5	-	Outline option HL Outline option HM	kg

Notes:-

- 1) Unless otherwise indicated T
- <sub>j</sub>
- =160°C.

**Notes on Ratings and Characteristics**

1.0 Voltage Grade Table

Voltage Grade	V <sub>RRM</sub> V	V <sub>RSM</sub> V	V <sub>R</sub> DC V
30	3000	3100	1700
32	3200	3300	1800
34	3400	3500	1850
35	3500	3600	1875

2.0 Extension of Voltage Grades

This report is applicable to other voltage grades when supply has been agreed by Sales/Production.

3.0 De-rating Factor

A blocking voltage de-rating factor of 0.13%/°C is applicable to this device for T<sub>j</sub> below 25°C.

4.0 Snubber Components

When selecting snubber components, care must be taken not to use excessively large values of snubber capacitor or excessively small values of snubber resistor. Such excessive component values may lead to device damage due to the large resultant values of snubber discharge current. If required, please consult the factory for assistance.

5.0 Computer Modelling Parameters

5.1 Device Dissipation Calculations

$$I_{AV} = \frac{-V_{T0} + \sqrt{V_{T0}^2 + 4 \cdot ff^2 \cdot r_T \cdot W_{AV}}}{2 \cdot ff^2 \cdot r_T} \quad \text{and:} \quad W_{AV} = \frac{\Delta T}{R_{th}}$$

$$\Delta T = T_{j\max} - T_K$$

Where V<sub>0</sub>=0.807V, r<sub>s</sub>=0.09mΩ,

R<sub>th</sub> = Supplementary thermal impedance, see table below and

ff = Form factor, see table below.

Supplementary Thermal Impedance				
Conduction Angle	6 phase (60°)	3 phase (120°)	½ wave (180°)	d.c.
Square wave Double Side Cooled	0.0138	0.0132	0.0128	0.012
Square wave Single Side Cooled	0.0262	0.0255	0.0250	0.024
Sine wave Double Side Cooled	0.0134	0.0129	0.0123	
Sine wave Single Side Cooled	0.0257	0.0251	0.0244	

Form Factors				
Conduction Angle	6 phase (60°)	3 phase (120°)	½ wave (180°)	d.c.
Square wave	2.449	1.732	1.414	1
Sine wave	2.778	1.879	1.57	

5.2 Calculating  $V_F$  using ABCD Coefficients

The on-state characteristic  $I_F$  vs.  $V_F$ , on page 5 is represented in two ways;

- (i) the well established  $V_0$  and  $r_s$  tangent used for rating purposes and
- (ii) a set of constants A, B, C, D, forming the coefficients of the representative equation for  $V_F$  in terms of  $I_F$  given below:

$$V_F = A + B \cdot \ln(I_F) + C \cdot I_F + D \cdot \sqrt{I_F}$$

The constants, derived by curve fitting software, are given below for both hot and cold characteristics. The resulting values for  $V_F$  agree with the true device characteristic over a current range, which is limited to that plotted.

25°C Coefficients		160°C Coefficients	
A	0.691735365	A	0.489564365
B	0.029196	B	0.025175
C	3.500000E-05	C	4.300000E-05
D	2.664000E-03	D	4.950000E-03

5.3 D.C. Thermal Impedance Calculation

$$r_t = \sum_{p=1}^{p=n} r_p \cdot \left( 1 - e^{-\frac{t}{\tau_p}} \right)$$

Where  $p = 1$  to  $n$ ,  $n$  is the number of terms in the series and:

- $t$  = Duration of heating pulse in seconds.
- $r_t$  = Thermal resistance at time  $t$ .
- $r_p$  = Amplitude of  $p$ th term.
- $\tau_p$  = Time Constant of  $r$ th term.

The coefficients for this device are shown in the tables below:

D.C. Double Side Cooled				
Term	1	2	3	4
$r_p$	$5.70694 \times 10^{-3}$	$4.354047 \times 10^{-3}$	$1.146543 \times 10^{-3}$	$8.138617 \times 10^{-4}$
$\tau_p$	1.486448	0.2518236	0.07993583	$5.569284 \times 10^{-3}$

D.C. Single Side Cooled				
Term	1	2	3	4
$r_p$	0.0162195	$5.732856 \times 10^{-3}$	$1.48536 \times 10^{-3}$	$7.633434 \times 10^{-4}$
$\tau_p$	8.431941	0.3637194	0.0701921	$4.56943 \times 10^{-3}$

**Curves**

Figure 1 – Forward characteristics of Limit device

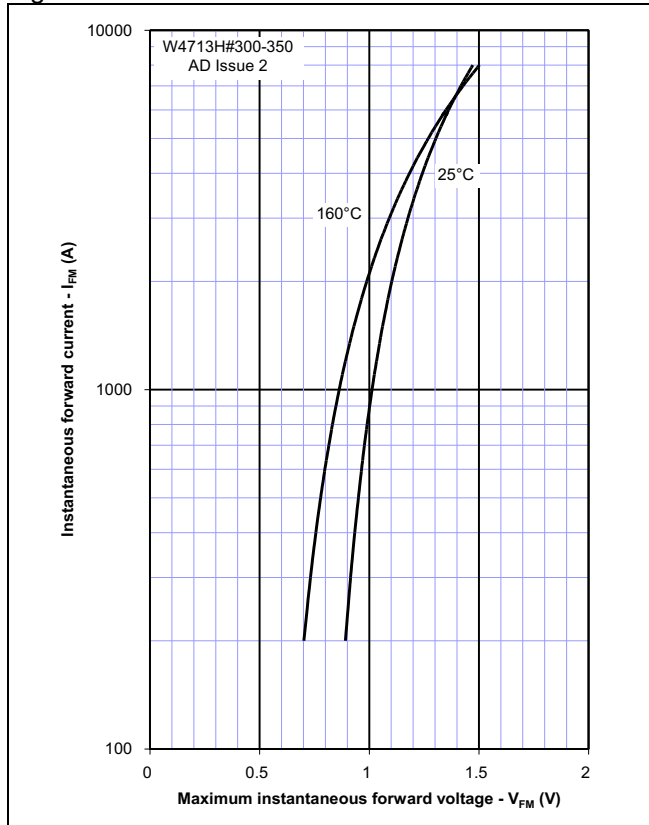

Figure 2 – Transient thermal impedance

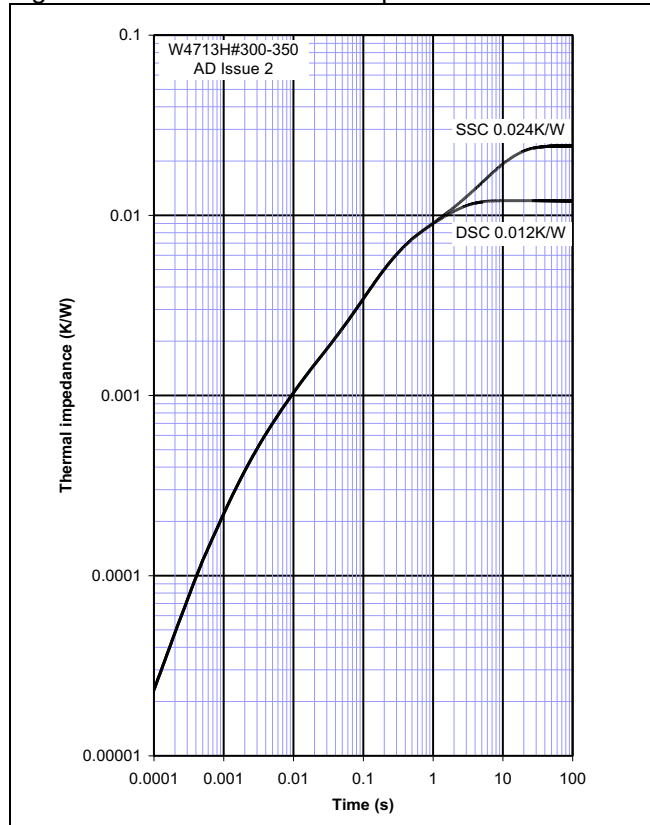

Figure 3 – Maximum surge Rating

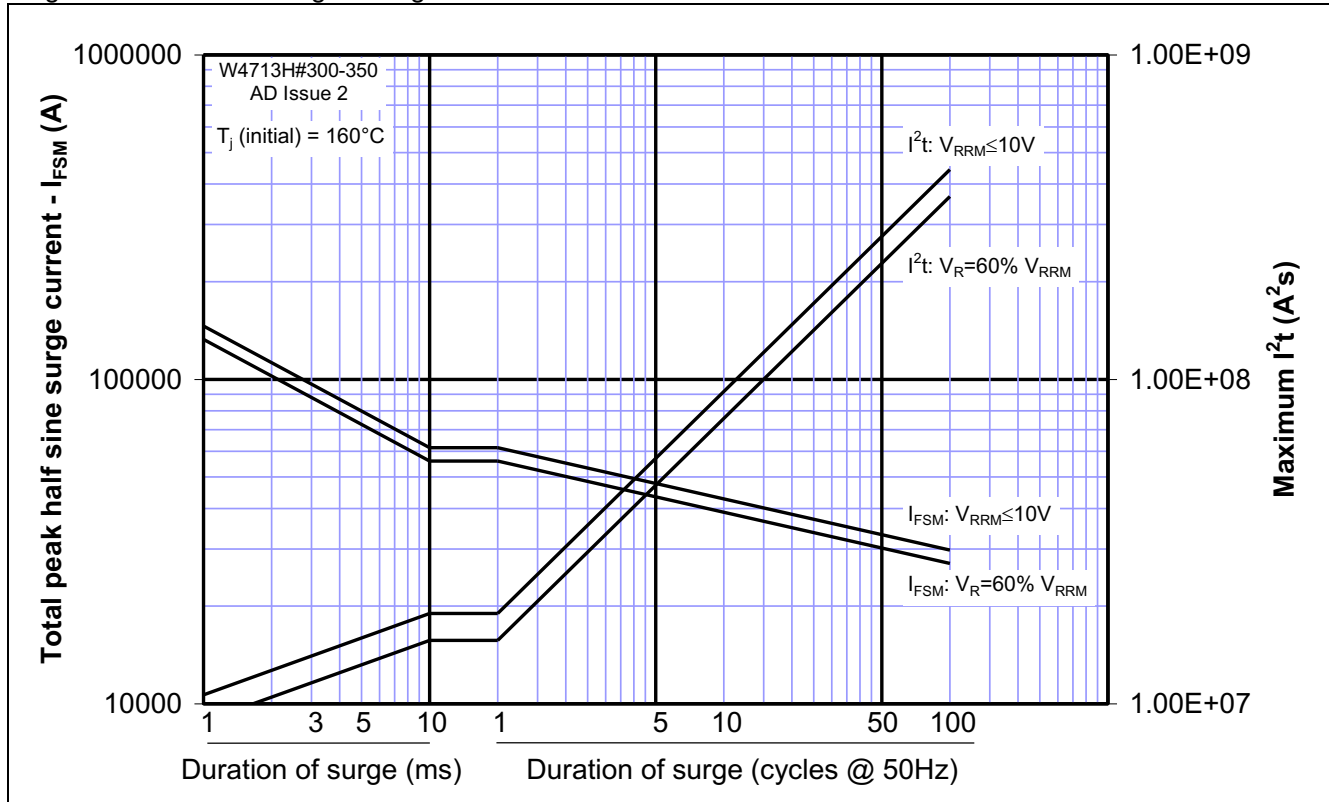

Figure 4 – Total recovered charge,  $Q_{rr}$

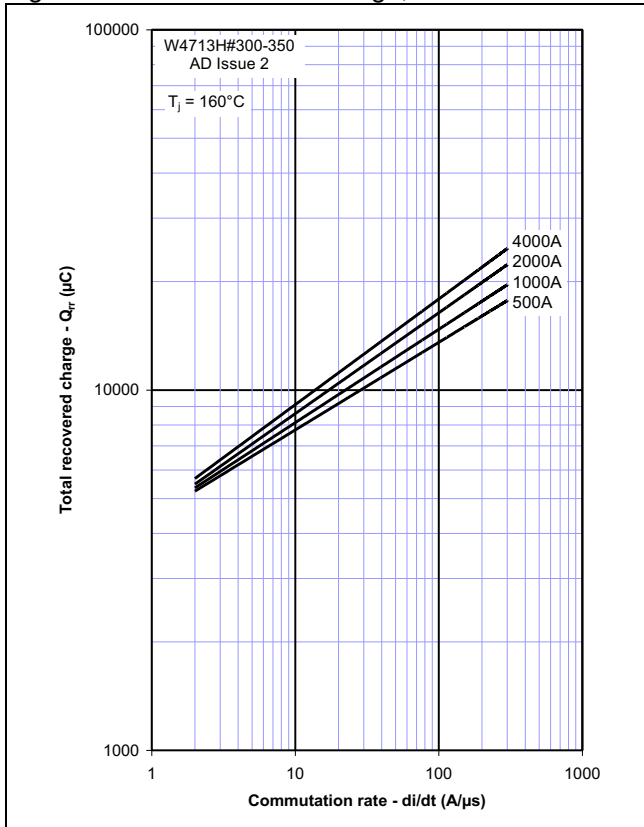

Figure 5 – Recovered charge,  $Q_{ra}$  (50% Chord)

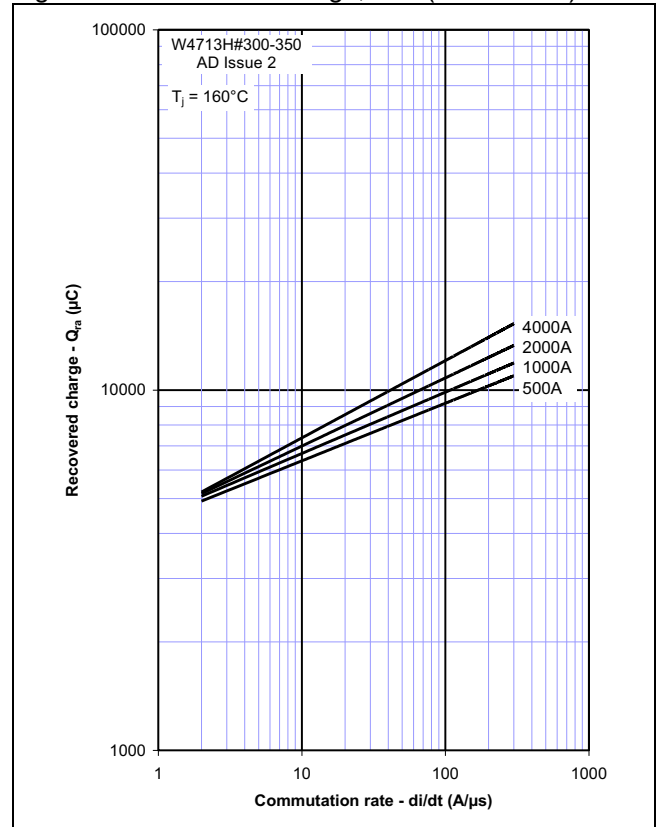

Figure 6 – Peak recovery current,  $I_{rr}$

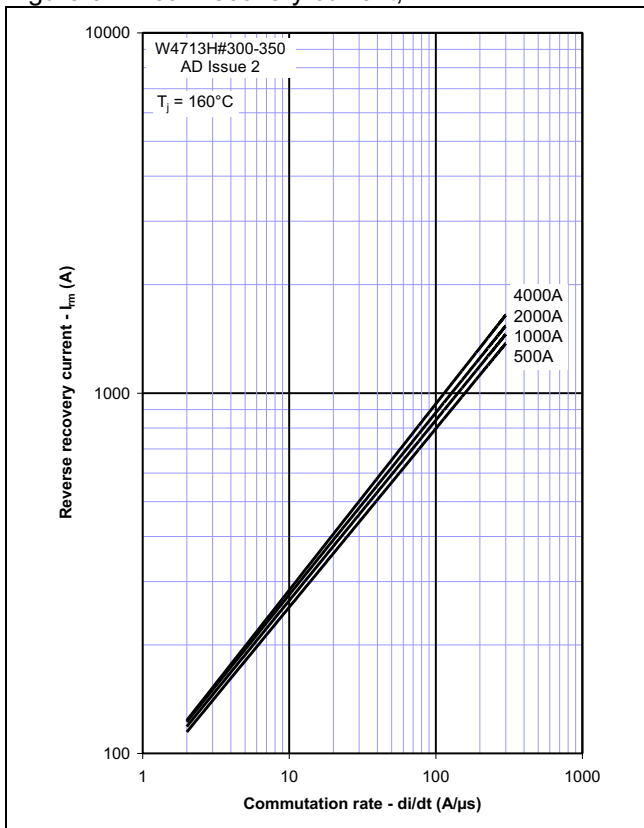

Figure 7 – Maximum recovery time,  $t_{rr}$  (50% Chord)

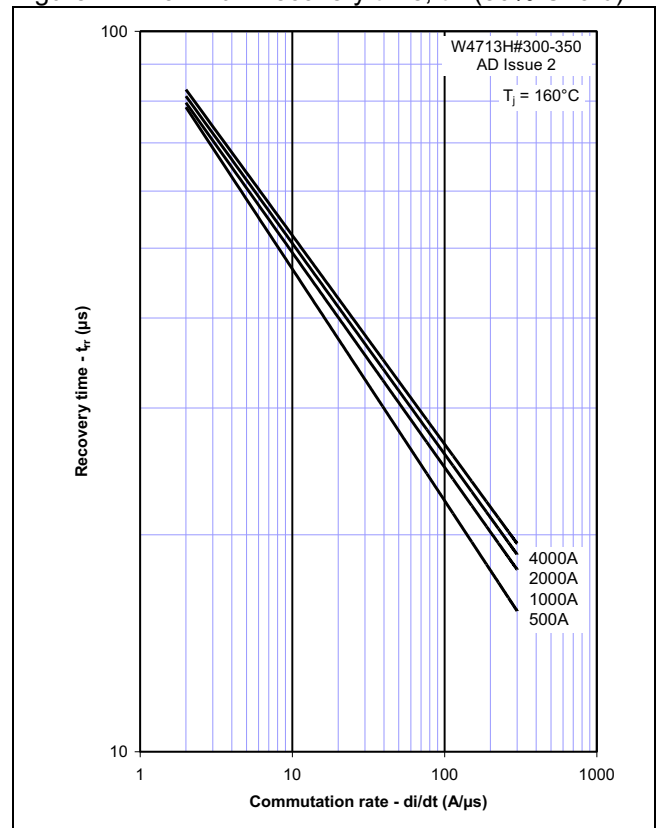

Figure 8 – Forward current vs. Power dissipation – Double Side Cooled

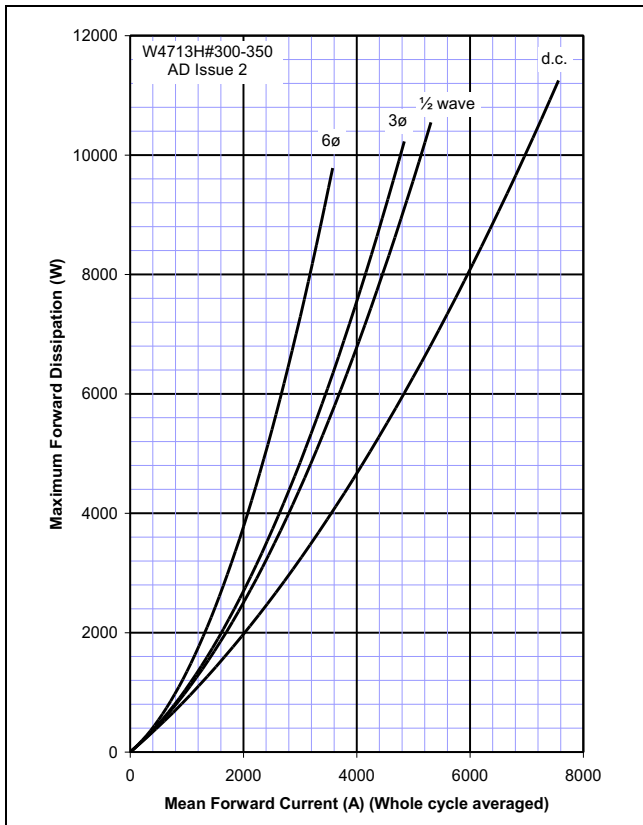

Figure 9 – Forward current vs. Heatsink temperature - Double Side Cooled

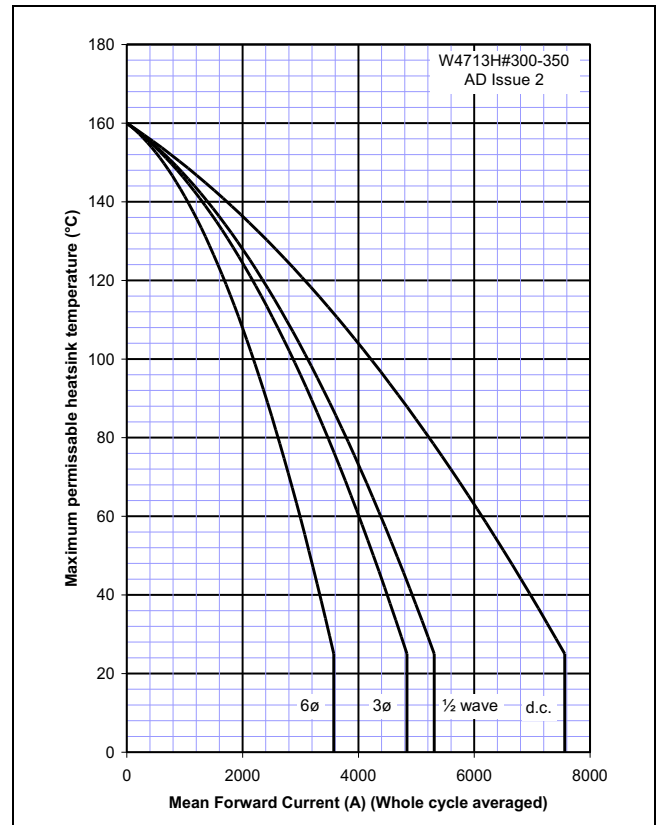

Figure 10 – Forward current vs. Power dissipation – Single Side Cooled

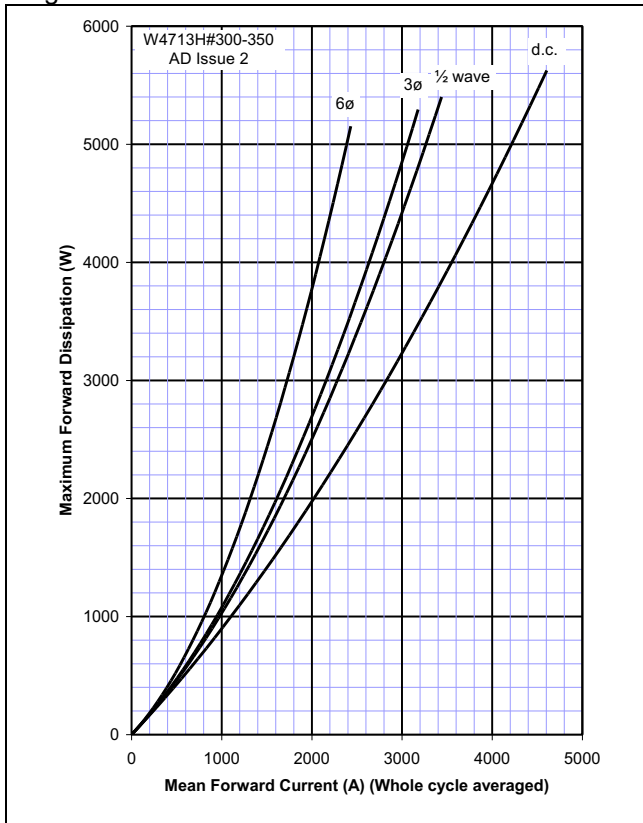
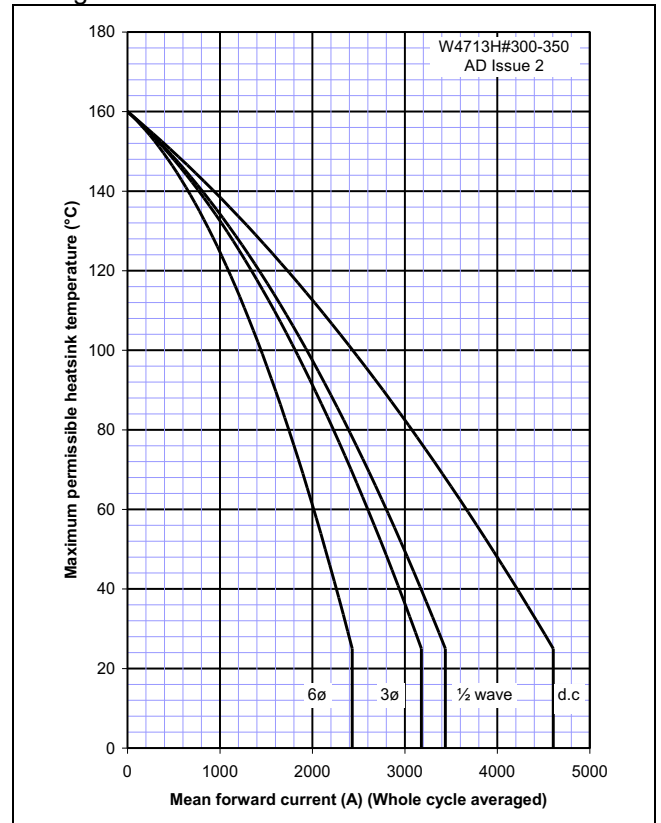
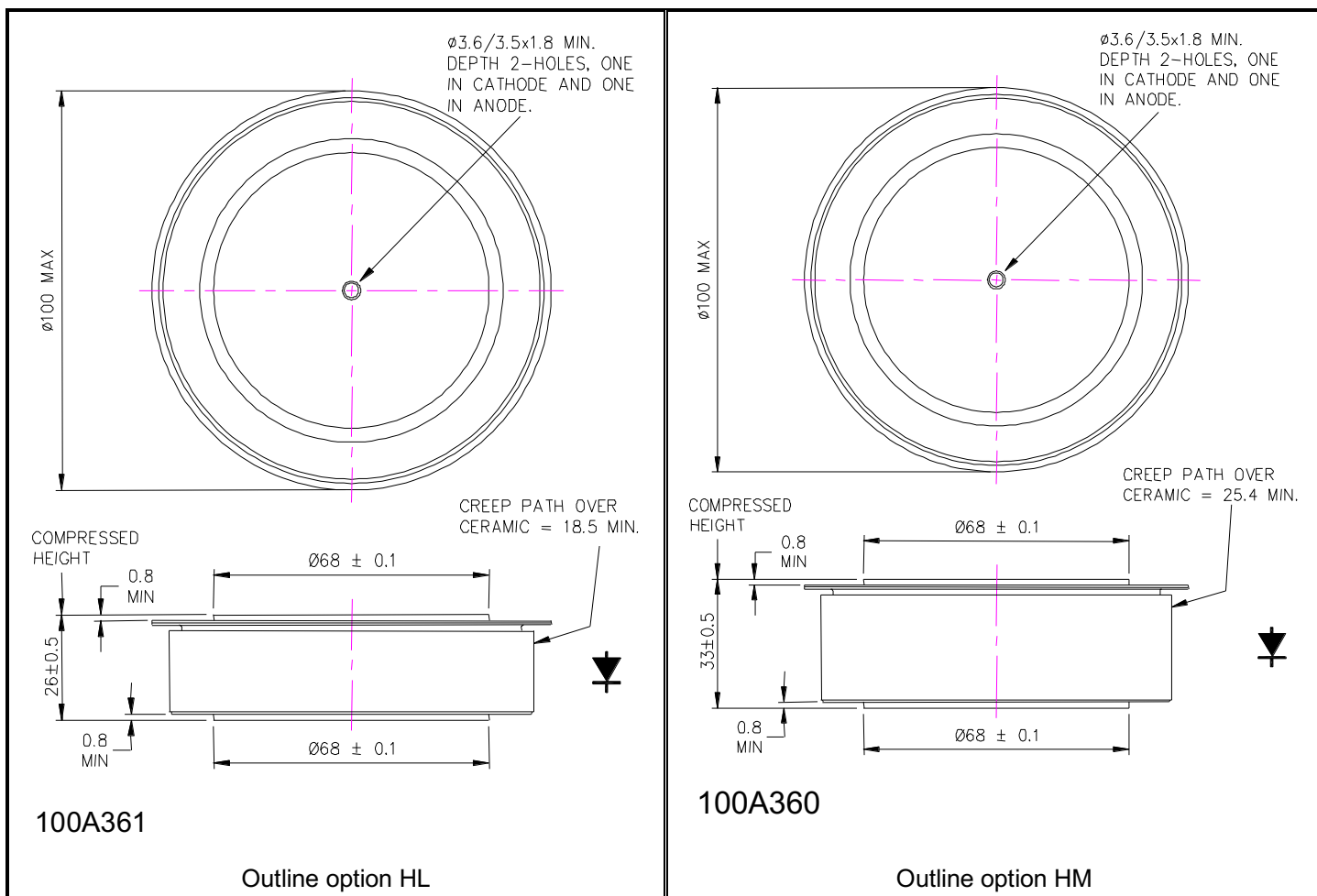

Figure 11 – Forward current vs. Heatsink temperature – Single Side Cooled



**Outline Drawing & Ordering Information**



**ORDERING INFORMATION**

(Please quote 10 digit code as below)

<b>W4713</b>	<b>H#</b>	<b>◆◆</b>	<b>0</b>
Fixed Type Code	Fixed outline code HL = 26mm Clamp height HM = 33mm Clamp height	Voltage code $V_{RRM}/100$ 30-35	Fixed code

Typical order code: W4713HL340 – 3400V  $V_{RRM}$ , 26mm clamp height capsule.

**IXYS Semiconductor GmbH**  
Edisonstraße 15  
D-68623 Lampertheim  
Tel: +49 6206 503-0  
Fax: +49 6206 503-627  
E-mail: [marcom@ixys.de](mailto:marcom@ixys.de)

**WESTCODE**  
An IXYS Company

**Westcode Semiconductors Ltd**  
Langley Park Way, Langley Park,  
Chippenham, Wiltshire, SN15 1GE.  
Tel: +44 (0)1249 444524  
Fax: +44 (0)1249 659448  
E-mail: [WSL.sales@westcode.com](mailto:WSL.sales@westcode.com)

**IXYS Corporation**  
3540 Bassett Street  
Santa Clara CA 95054 USA  
Tel: +1 (408) 982 0700  
Fax: +1 (408) 496 0670  
E-mail: [sales@ixys.net](mailto:sales@ixys.net)

[www.westcode.com](http://www.westcode.com)

[www.ixys.com](http://www.ixys.com)

**IXYS Long Beach**  
3270 Cherry Avenue  
Long Beach CA 90807 USA  
Tel: +1 (562) 595 6971  
Fax: +1 (562) 595 8182  
E-mail: [WSL.sales@westcode.com](mailto:WSL.sales@westcode.com)

The information contained herein is confidential and is protected by Copyright. The information may not be used or disclosed except with the written permission of and in the manner permitted by the proprietors Westcode Semiconductors Ltd.

© Westcode Semiconductors Ltd.

In the interest of product improvement, Westcode reserves the right to change specifications at any time without prior notice.

Devices with a suffix code (2-letter, 3-letter or letter/digit/letter combination) added to their generic code are not necessarily subject to the conditions and limits contained in this report.





---

Disclaimer Notice - Information furnished is believed to be accurate and reliable. However, users should independently evaluate the suitability of and test each product selected for their own applications. Littelfuse products are not designed for, and may not be used in, all applications. Read complete Disclaimer Notice at [www.littelfuse.com/disclaimer-electronics](http://www.littelfuse.com/disclaimer-electronics).