

Phase Control Thyristor

Type N4803FC300-350

Old Type No.: N1683CH29-35

Absolute Maximum Ratings

	VOLTAGE RATINGS	MAXIMUM LIMITS	UNITS
V_{DRM}	Repetitive peak off-state voltage, (note 1)	3000-3500	V
V_{DSM}	Non-repetitive peak off-state voltage, (note 1)	3000-3500	V
V_{RRM}	Repetitive peak reverse voltage, (note 1)	3000-3500	V
V_{RSM}	Non-repetitive peak reverse voltage, (note 1)	3100-3600	V

	OTHER RATINGS	MAXIMUM LIMITS	UNITS
$I_{T(AV)}$	Mean on-state current. $T_{sink}=55^{\circ}C$, (note 2)	4803	A
$I_{T(AV)}$	Mean on-state current. $T_{sink}=85^{\circ}C$, (note 2)	3356	A
$I_{T(AV)}$	Mean on-state current. $T_{sink}=85^{\circ}C$, (note 3)	2072	A
$I_{T(RMS)}$	Nominal RMS on-state current. $T_{sink}=25^{\circ}C$, (note 2)	9453	A
$I_{T(d.c.)}$	D.C. on-state current. $T_{sink}=25^{\circ}C$, (note 4)	8362	A
I_{TSM}	Peak non-repetitive surge $t_p=10ms$, $V_{rm}=0.6V_{RRM}$, (note 5)	60	kA
I_{TSM2}	Peak non-repetitive surge $t_p=10ms$, $V_{rm}\leq 10V$, (note 5)	67	kA
I^2t	I^2t capacity for fusing $t_p=10ms$, $V_{rm}=0.6V_{RRM}$, (note 5)	18.0×10^6	A^2s
I^2t	I^2t capacity for fusing $t_p=10ms$, $V_{rm}\leq 10V$, (note 5)	22.5×10^6	A^2s
di_T/dt	Maximum rate of rise of on-state current (repetitive), (Note 6)	150	$A/\mu s$
	Maximum rate of rise of on-state current (non-repetitive), (Note 6)	300	$A/\mu s$
V_{RGM}	Peak reverse gate voltage	5	V
$P_{G(AV)}$	Mean forward gate power	5	W
P_{GM}	Peak forward gate power	50	W
V_{GD}	Non-trigger gate voltage, (Note 7)	0.25	V
T_{HS}	Operating temperature range	-40 to +125	$^{\circ}C$
T_{stg}	Storage temperature range	-40 to +150	$^{\circ}C$

Notes: -

- 1) De-rating factor of 0.13% per $^{\circ}C$ is applicable for T_j below $25^{\circ}C$.
- 2) Double side cooled, single phase; 50Hz, 180° half-sinewave.
- 3) Single side cooled, single phase; 50Hz, 180° half-sinewave.
- 4) Double side cooled.
- 5) Half-sinewave, $125^{\circ}C$ T_j initial.
- 6) $V_D=67\% V_{DRM}$, $I_{TM}=1000A$, $I_{FG}=2A$, $t_r\leq 0.5\mu s$, $T_{case}=125^{\circ}C$.
- 7) Rated V_{DRM} .

Characteristics

	PARAMETER	MIN.	TYP.	MAX.	TEST CONDITIONS (Note 1)	UNITS
V_{TM}	Maximum peak on-state voltage	-	-	1.6	$I_{TM}=6000A$	V
V_0	Threshold voltage	-	-	0.92		V
r_s	Slope resistance	-	-	0.11		m Ω
dv/dt	Critical rate of rise of off-state voltage	1000	-	-	$V_D=80\% V_{DRM}$, Linear ramp, gate o/c	V/ μs
I_{DRM}	Peak off-state current	-	-	300	Rated V_{DRM}	mA
I_{RRM}	Peak reverse current	-	-	300	Rated V_{RRM}	mA
V_{GT}	Gate trigger voltage	-	-	3.0	$T_j=25^\circ C$, $V_D=10V$, $I_T=3A$	V
I_{GT}	Gate trigger current	-	-	300		mA
I_H	Holding current	-	-	1000	$T_j=25^\circ C$	mA
t_{gd}	Gate controlled turn-on delay time	-	1.0	2.0	$I_{FG}=2A$, $t_r=0.5\mu s$, $V_D=67\%V_{DRM}$, $I_{TM}=2000A$, $di/dt=10A/\mu s$, $T_j=25^\circ C$	μs
t_{gt}	Turn-on time	-	2.0	3.0		
Q_{rr}	Recovered Charge	-	12000	-		μC
Q_{ra}	Recovered Charge, 50% chord	-	7000	10500	$I_{TM}=4000A$, $t_p=2ms$, $di/dt=10A/\mu s$, $V_r=50V$	μC
I_{rm}	Reverse recovery current	-	280	-		A
t_{rr}	Reverse recovery time, 50% chord	-	50	-		μs
t_q	Turn-off time	-	620	-	$I_{TM}=4000A$, $t_p=2ms$, $di/dt=10A/\mu s$, $V_r=50V$, $V_{dr}=67\%V_{DRM}$, $dV_{dr}/dt=20V/\mu s$	μs
		-	850	-	$I_{TM}=4000A$, $t_p=2ms$, $di/dt=10A/\mu s$, $V_r=50V$, $V_{dr}=67\%V_{DRM}$, $dV_{dr}/dt=200V/\mu s$	
R_θ	Thermal resistance, junction to heatsink	-	-	0.0065	Double side cooled	K/W
		-	-	0.013	Single side cooled	K/W
F	Mounting force	81	-	99		kN
W_t	Weight	-	2.8	-		kg

Notes: -

1) Unless otherwise indicated $T_j=125^\circ C$.

Notes on Ratings and Characteristics

1.0 Voltage Grade Table

Voltage Grade	V_{DRM} V_{DSM} V_{RRM} V	V_{RSM} V	V_D V_R DC V
30	3000	3100	1860
31	3100	3200	1920
32	3200	3300	1980
33	3300	3400	2040
34	3400	3500	2100
35	3500	3600	2160

2.0 Extension of Voltage Grades

This report is applicable to other and higher voltage grades when supply has been agreed by Sales/Production.

3.0 De-rating Factor

A blocking voltage de-rating factor of 0.13%/°C is applicable to this device for T_j below 25°C.

4.0 Repetitive dv/dt

Standard dv/dt is 1000V/μs.

5.0 Computer Modelling Parameters

5.1 Device Dissipation Calculations

$$I_{AV} = \frac{-V_0 + \sqrt{V_0^2 + 4 \cdot ff \cdot r_s \cdot W_{AV}}}{2 \cdot ff \cdot r_s} \quad \text{and:} \quad W_{AV} = \frac{\Delta T}{R_{th}}$$

$$\Delta T = T_{j\max} - T_{Hs}$$

Where $V_0=0.92V$, $r_s=0.11m\Omega$,

R_{th} = Supplementary thermal impedance, see table below.

ff = Form factor, see table below.

Supplementary Thermal Impedance							
Conduction Angle	30°	60°	90°	120°	180°	270°	d.c.
Square wave Double Side Cooled	0.00717	0.00707	0.00698	0.00689	0.00673	0.00652	0.0065
Square wave Single Side Cooled	0.0137	0.01359	0.01349	0.0134	0.01323	0.01301	0.013
Sine wave Double Side Cooled	0.00709	0.00697	0.00687	0.00678	0.00654		
Sine wave Single Side Cooled	0.0136	0.01348	0.01337	0.01328	0.01303		

Form Factors							
Conduction Angle	30°	60°	90°	120°	180°	270°	d.c.
Square wave	3.46	2.45	2	1.73	1.41	1.15	1
Sine wave	3.98	2.78	2.22	1.88	1.57		

5.2 Calculating V_T using ABCD Coefficients

The on-state characteristic I_T vs. V_T , on page 5 is represented in two ways;

- (i) the well established V_o and r_s tangent used for rating purposes and
- (ii) a set of constants A, B, C, D, forming the coefficients of the representative equation for V_T in terms of I_T given below:

$$V_T = A + B \cdot \ln(I_T) + C \cdot I_T + D \cdot \sqrt{I_T}$$

The constants, derived by curve fitting software, are given below for hot characteristics. The resulting values for V_T agree with the true device characteristic over a current range, which is limited to that plotted.

125°C Coefficients	
A	0.861185
B	0.02416985
C	1.342070×10^{-4}
D	-3.560819×10^{-3}

5.3 D.C. Thermal Impedance Calculation

$$r_t = \sum_{p=1}^{p=n} r_p \cdot \left(1 - e^{-\frac{t}{\tau_p}} \right)$$

Where $p = 1$ to n , n is the number of terms in the series and:

- t = Duration of heating pulse in seconds.
- r_t = Thermal resistance at time t .
- r_p = Amplitude of p_{th} term.
- τ_p = Time Constant of r_{th} term.

D.C. Double Side Cooled				
Term	1	2	4	5
r_p	3.424745×10^{-3}	1.745273×10^{-3}	8.532017×10^{-4}	3.457329×10^{-4}
τ_p	1.125391	0.1878348	0.02788979	8.430889×10^{-3}

D.C. Single Side Cooled				
Term	1	2	5	6
r_p	8.375269×10^{-3}	2.518437×10^{-3}	1.193758×10^{-3}	7.45432×10^{-4}
τ_p	8.929845	0.4711304	0.08221244	0.01221961

Curves

Figure 1 – On-state characteristics of Limit device

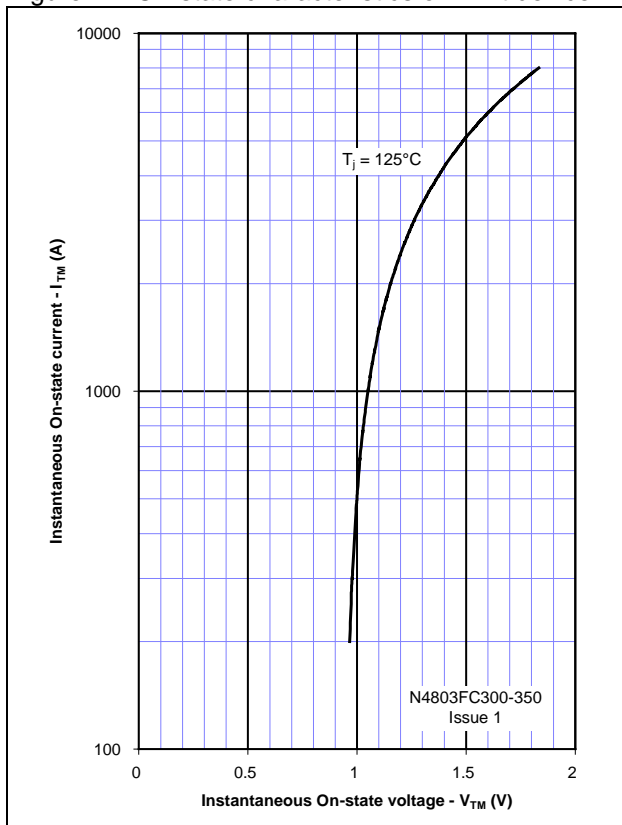

Figure 2 – Transient Thermal Impedance

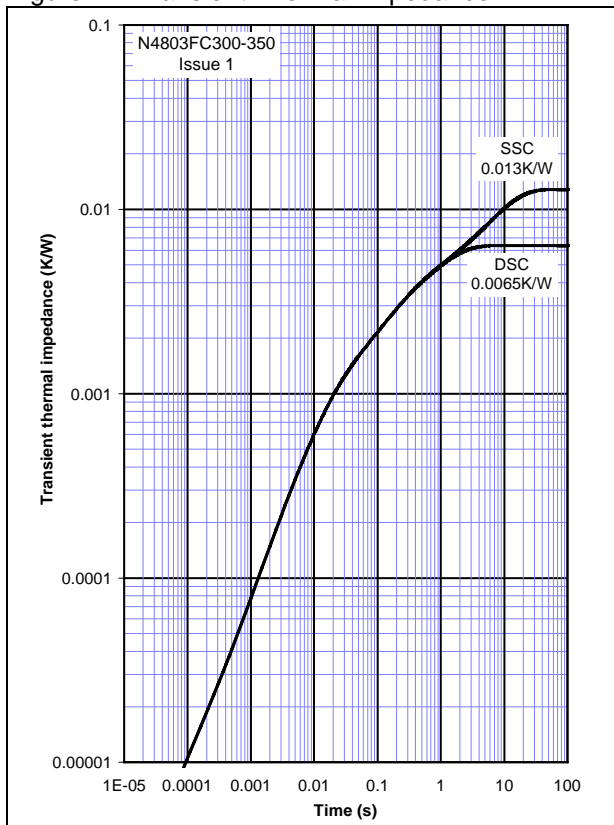

Figure 3 – Gate Characteristics - Trigger Limits

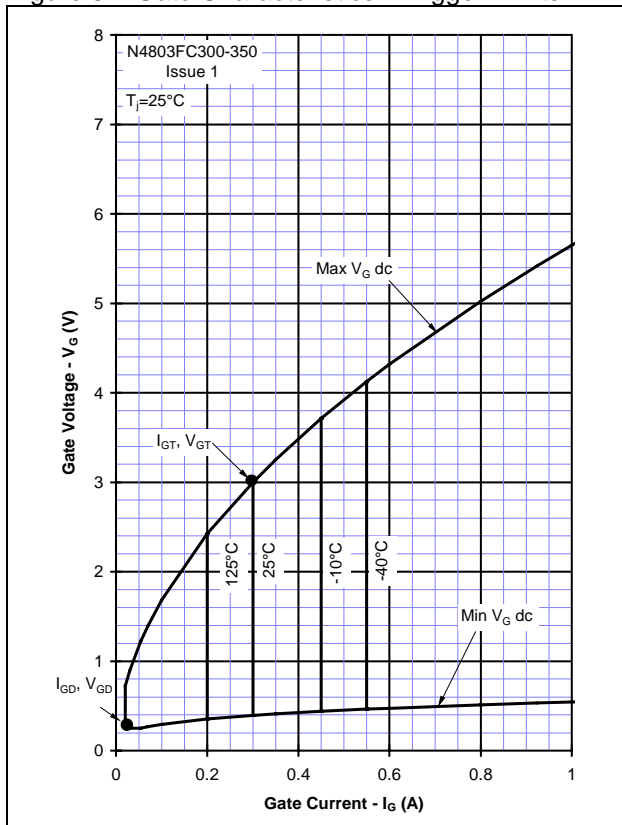

Figure 4 – Gate Characteristics - Power Curves

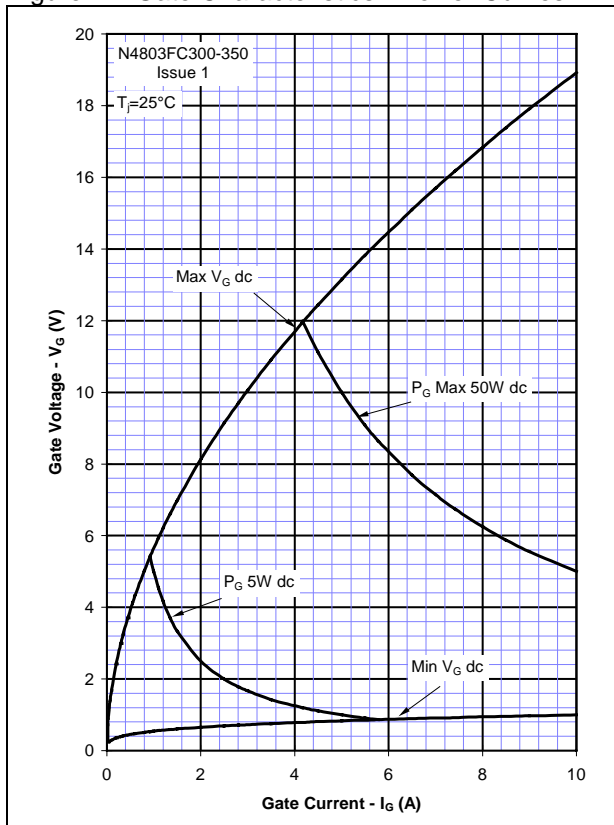

Figure 5 – Recovered Charge, Q_{rr}

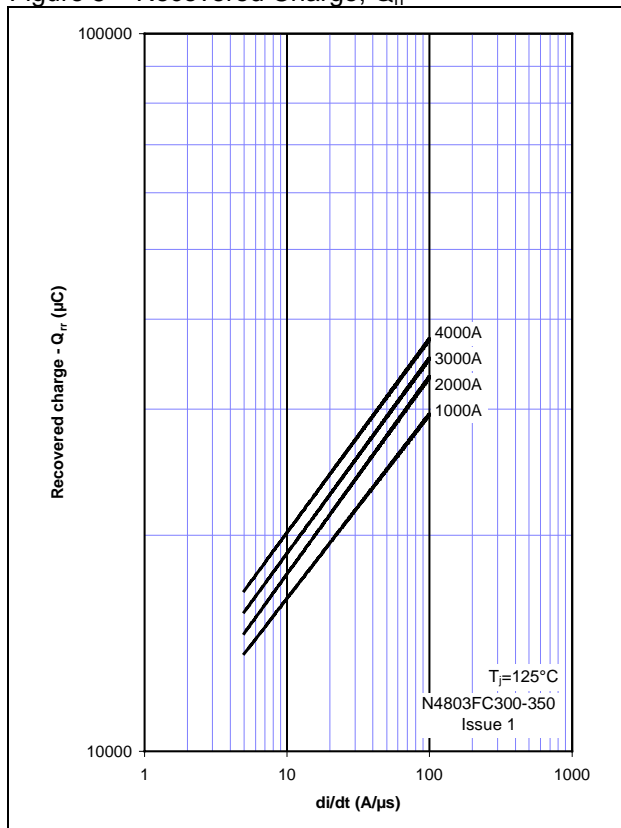

Figure 6 – Recovered charge, Q_{ra} (50% chord)

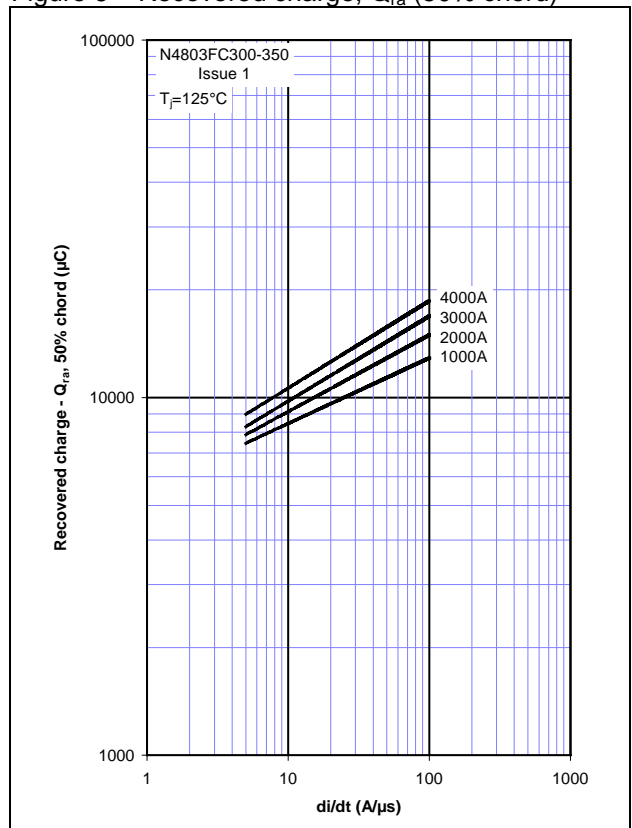

Figure 7 – Reverse recovery current, I_{rm}

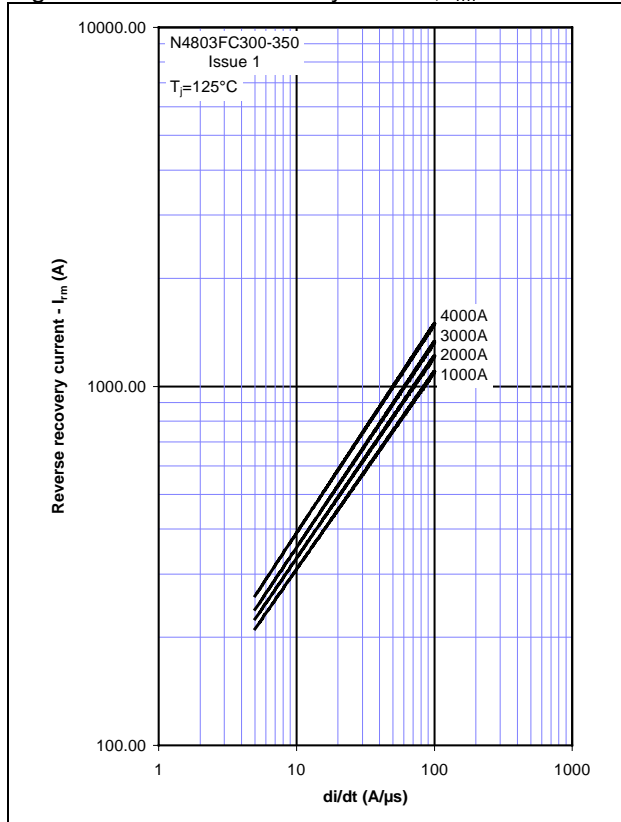

Figure 8 – Reverse recovery time, t_{rr}

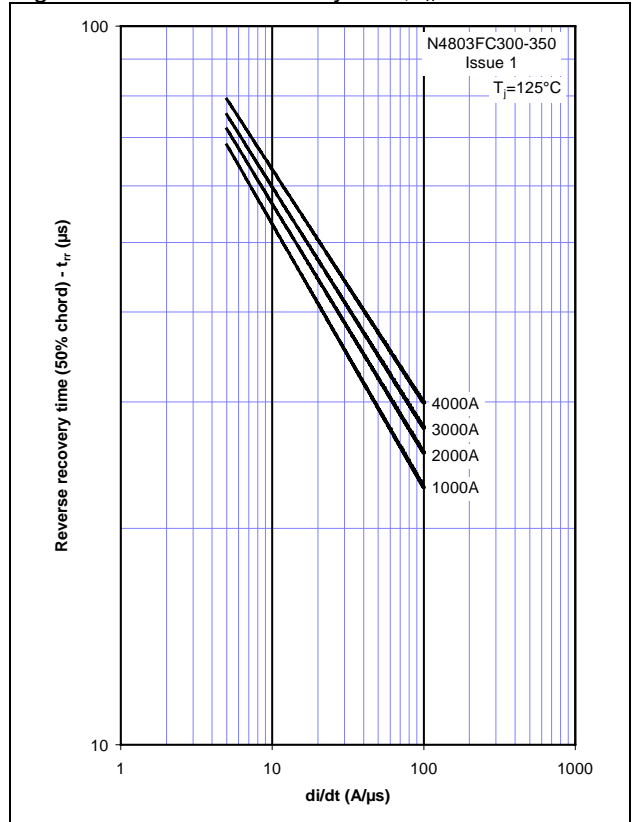

Figure 9 – On-state current vs. Power dissipation – Double Side Cooled (Sine wave)

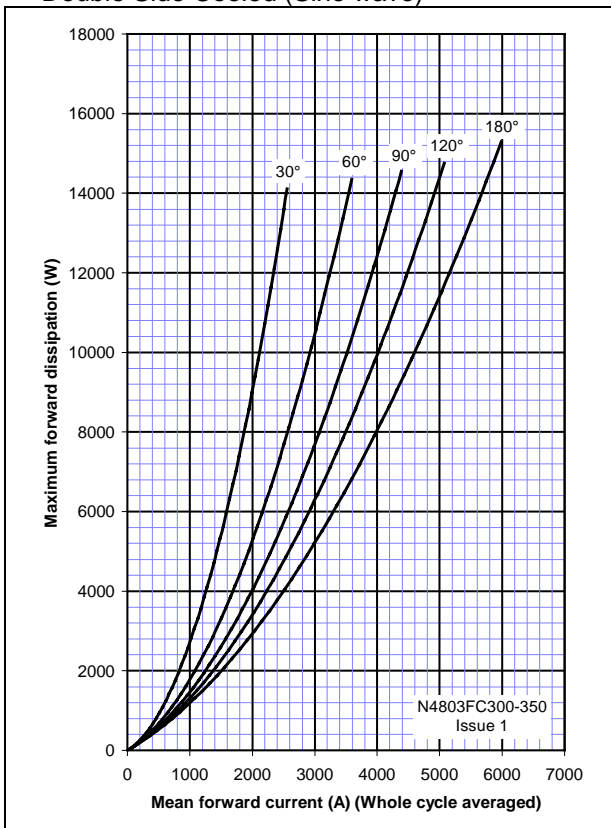

Figure 10 – On-state current vs. Heatsink temperature - Double Side Cooled (Sine wave)

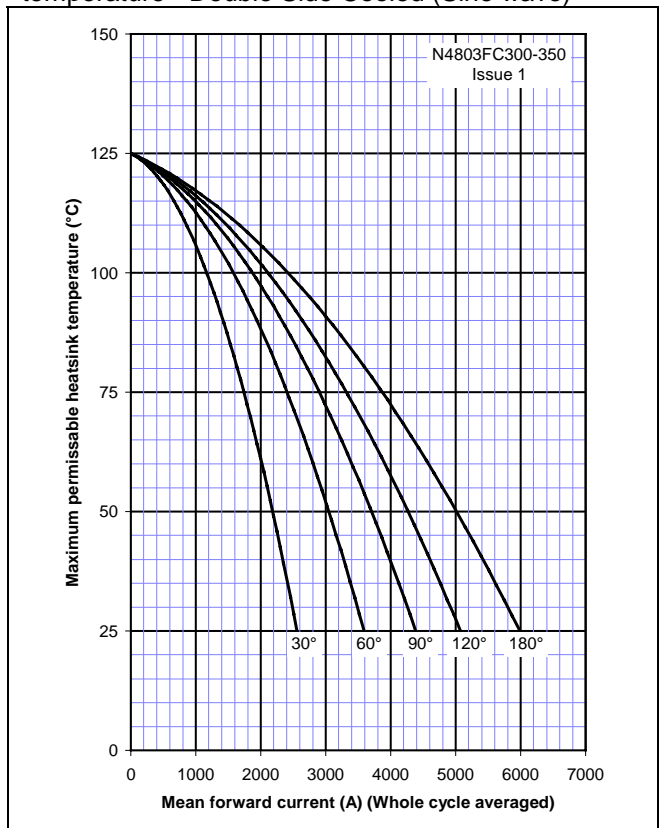

Figure 11 – On-state current vs. Power dissipation – Double Side Cooled (Square wave)

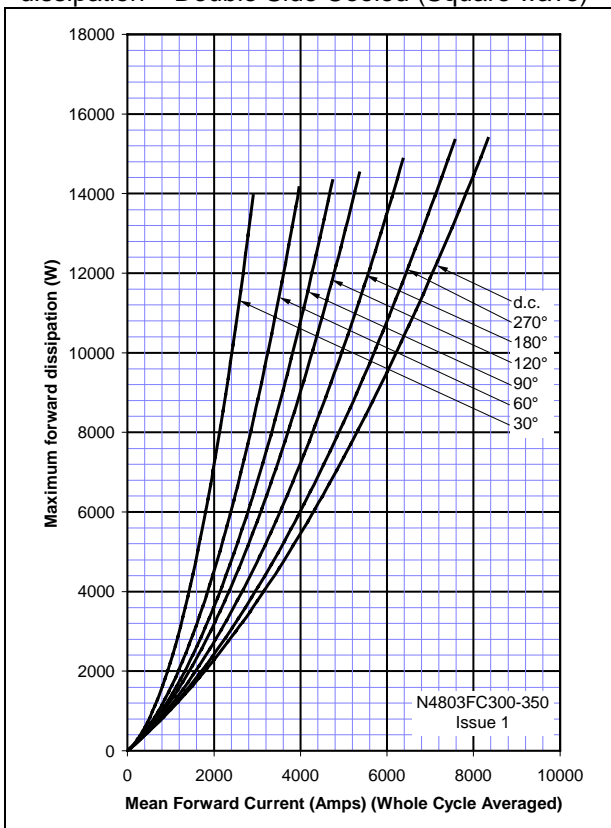

Figure 12 – On-state current vs. Heatsink temperature - Double Side Cooled (Square wave)

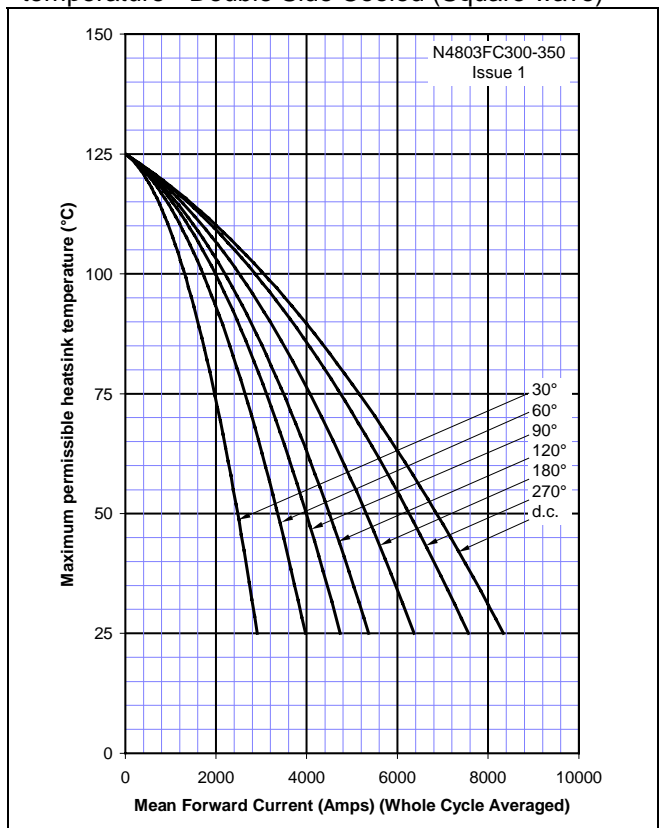

Figure 13 – On-state current vs. Power dissipation – Single Side Cooled (Sine wave)

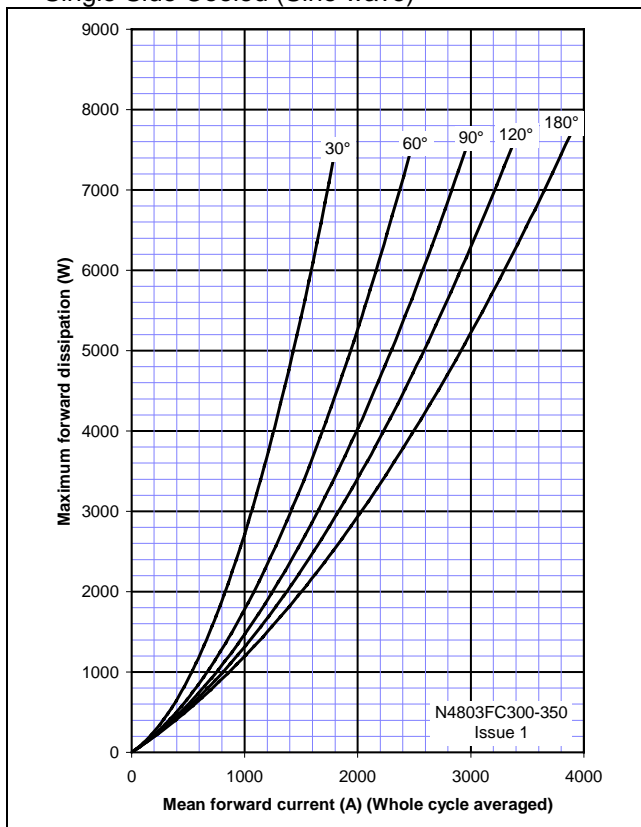

Figure 14 – On-state current vs. Heatsink temperature - Single Side Cooled (Sine wave)

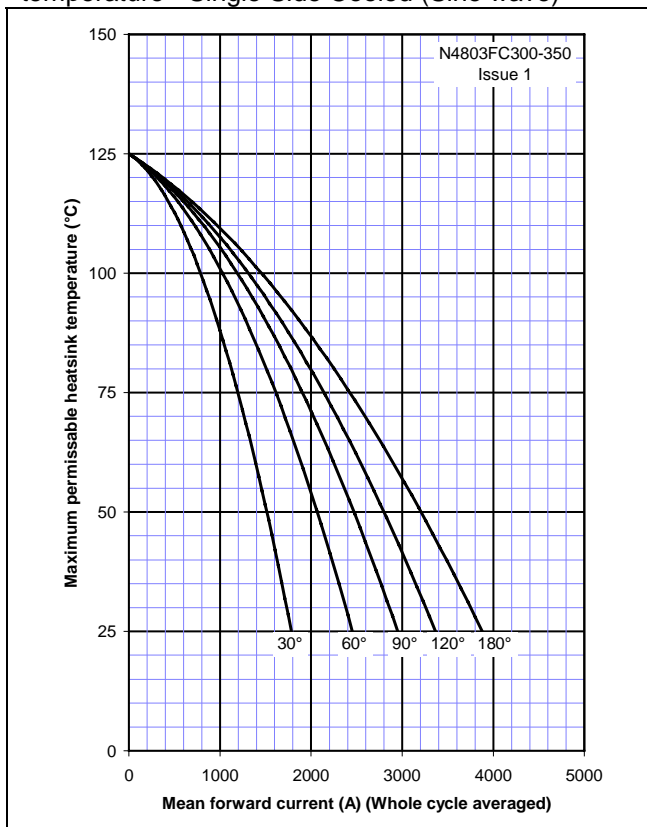

Figure 15 – On-state current vs. Power dissipation – Single Side Cooled (Square wave)

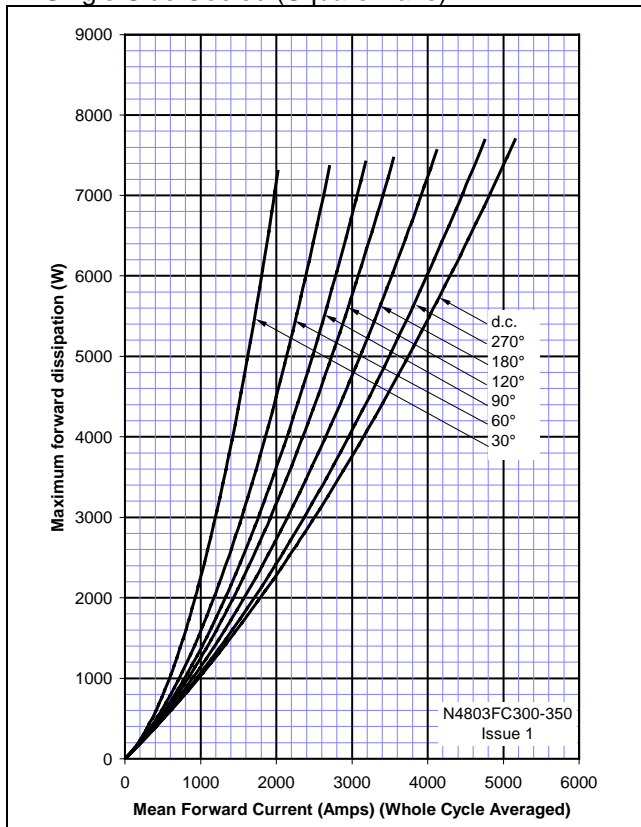

Figure 16 – On-state current vs. Heatsink temperature - Single Side Cooled (Square wave)

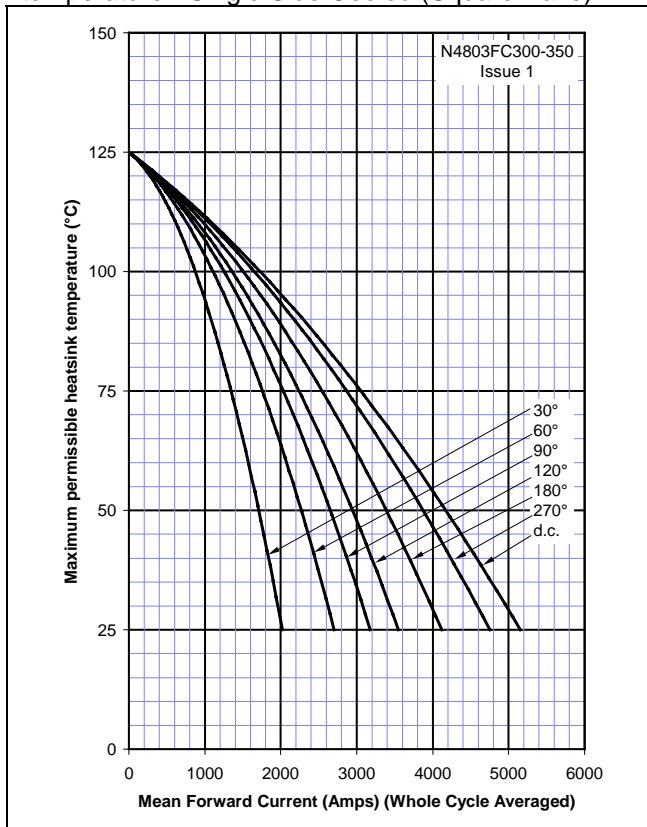
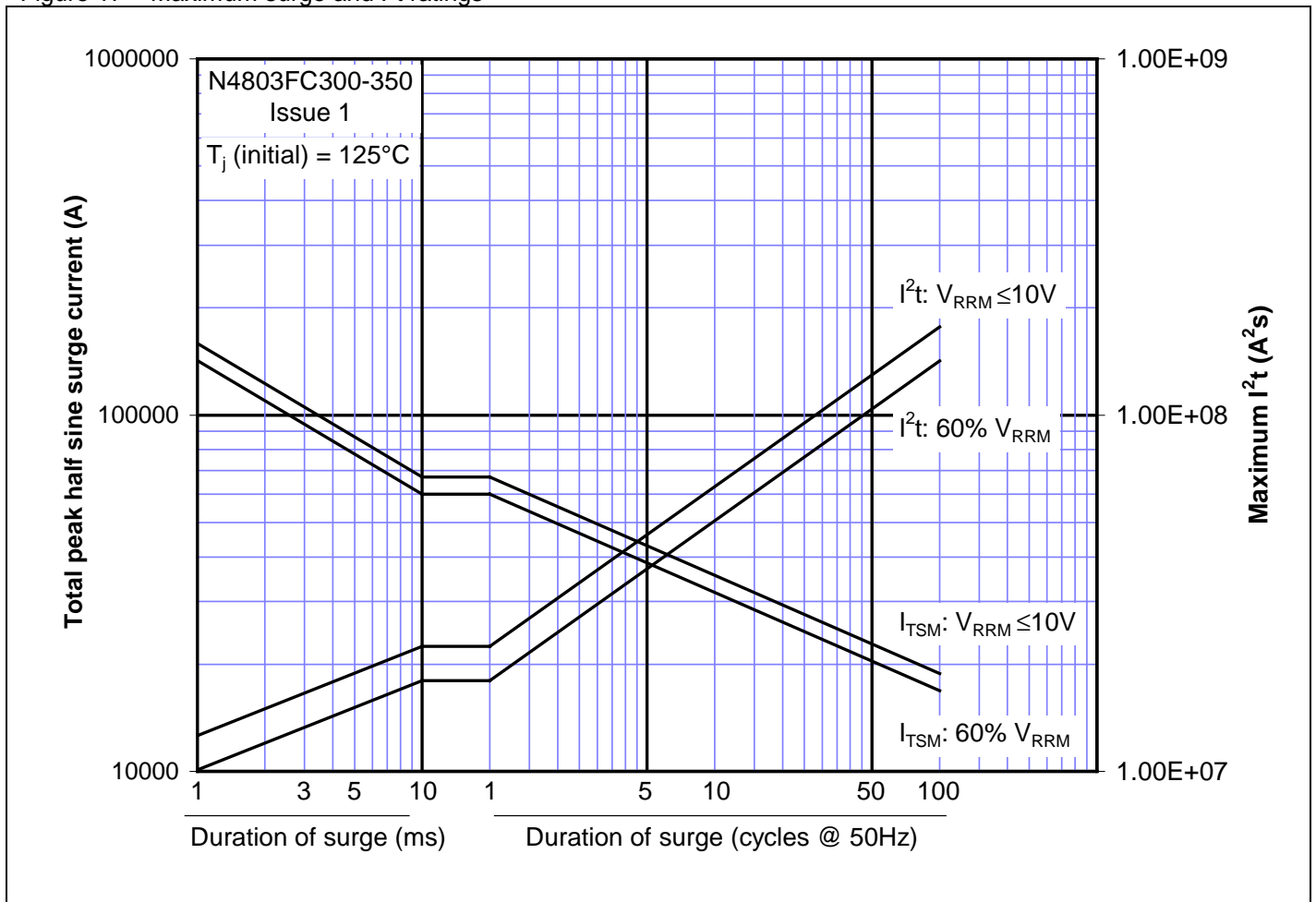
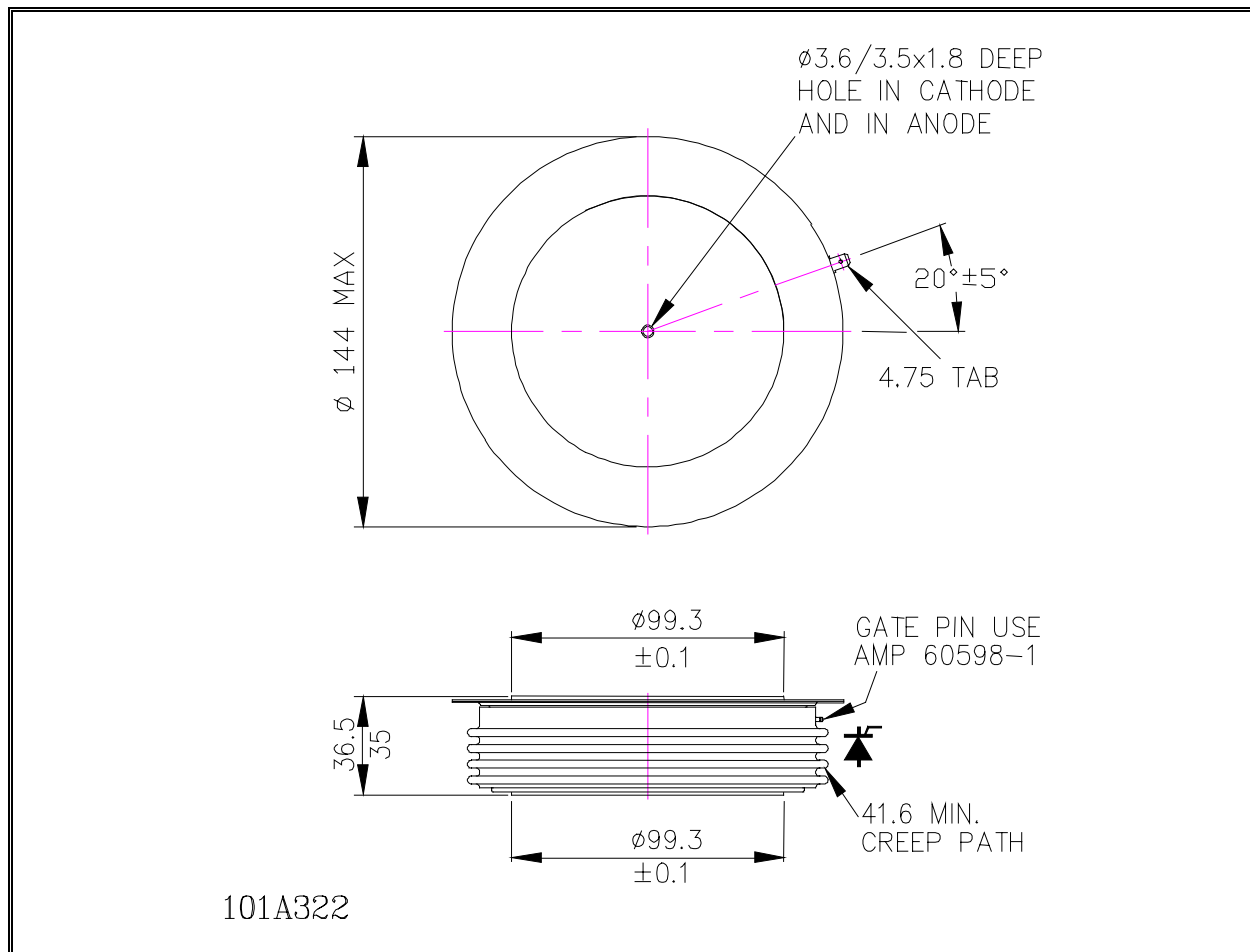

Figure 17 – Maximum surge and I^2t ratings



Outline Drawing & Ordering Information



ORDERING INFORMATION			
(Please quote 10 digit code as below)			
N4803	FC	◆◆	0
Fixed Type Code	Fixed outline code	Voltage code $V_{DRM}/100$ 30-35	Fixed code

Order code: N4803FC320 – 3200V V_{RRM} , 36.5mm clamp height capsule.

IXYS Semiconductor GmbH
 Edisonstraße 15
 D-68623 Lampertheim
 Tel: +49 6206 503-0
 Fax: +49 6206 503-627
 E-mail: marcom@ixys.de

WESTCODE
 An IXYS Company

Westcode Semiconductors Ltd
 PO Box 57 Chippenham
 Wiltshire SN15 1JL
 Tel: +44 (0)1249 444524
 Fax: +44 (0)1249 659448
 E-mail: WSL.sales@westcode.com

IXYS Corporation
 3540 Bassett Street
 Santa Clara CA 95054 USA
 Tel: +1 (408) 982 0700
 Fax: +1 (408) 496 0670
 E-mail: sales@ixys.net

www.westcode.com

www.ixys.net

Westcode Semiconductors Inc
 3270 Cherry Avenue
 Long Beach CA 90807 USA
 Tel: +1 (562) 595 6971
 Fax: +1 (562) 595 8182
 E-mail: WSI.sales@westcode.com

The information contained herein is confidential and is protected by Copyright. The information may not be used or disclosed except with the written permission of and in the manner permitted by the proprietors Westcode Semiconductors Ltd.

© Westcode Semiconductors Ltd.

In the interest of product improvement, Westcode reserves the right to change specifications at any time without prior notice.

Devices with a suffix code (2-letter or letter/digit/letter combination) added to their generic code are not necessarily subject to the conditions and limits contained in this report.