

## Phase Control Thyristor Types N2500VC120 to N2500VC160

### Absolute Maximum Ratings

	VOLTAGE RATINGS	MAXIMUM LIMITS	UNITS
$V_{DRM}$	Repetitive peak off-state voltage, (note 1)	1200-1600	V
$V_{DSM}$	Non-repetitive peak off-state voltage, (note 1)	1200-1600	V
$V_{RRM}$	Repetitive peak reverse voltage, (note 1)	1200-1600	V
$V_{RSM}$	Non-repetitive peak reverse voltage, (note 1)	1300-1700	V

	OTHER RATINGS	MAXIMUM LIMITS	UNITS
$I_{T(AV)}$	Mean on-state current. $T_{sink}=55^{\circ}C$ , (note 2)	2500	A
$I_{T(AV)}$	Mean on-state current. $T_{sink}=85^{\circ}C$ , (note 2)	1684	A
$I_{T(AV)}$	Mean on-state current. $T_{sink}=85^{\circ}C$ , (note 3)	992	A
$I_{T(RMS)}$	Nominal RMS on-state current. $T_{sink}=25^{\circ}C$ , (note 2)	4985	A
$I_{T(d.c.)}$	D.C. on-state current. $T_{sink}=25^{\circ}C$ , (note 4)	4199	A
$I_{TSM}$	Peak non-repetitive surge $t_p=10ms$ , $V_{rm}=0.6V_{RRM}$ , (note 5)	37000	A
$I_{TSM2}$	Peak non-repetitive surge $t_p=10ms$ , $V_{rm}\leq 10V$ , (note 5)	45000	A
$I^2t$	$I^2t$ capacity for fusing $t_p=10ms$ , $V_{rm}=0.6V_{RRM}$ , (note 5)	$6.85\times 10^6$	$A^2s$
$I^2t$	$I^2t$ capacity for fusing $t_p=10ms$ , $V_{rm}\leq 10V$ , (note 5)	$10.1\times 10^6$	$A^2s$
$di_T/dt$	Maximum rate of rise of on-state current (repetitive), (Note 6)	150	$A/\mu s$
$di_T/dt$	Maximum rate of rise of on-state current (non-repetitive), (Note 6)	300	$A/\mu s$
$V_{RGM}$	Peak reverse gate voltage	5	V
$P_{G(AV)}$	Mean forward gate power	5	W
$P_{GM}$	Peak forward gate power	30	W
$V_{GD}$	Non-trigger gate voltage, (Note 7)	0.25	V
$T_{HS}$	Operating temperature range	-40 to +125	$^{\circ}C$
$T_{stg}$	Storage temperature range	-40 to +150	$^{\circ}C$

Notes: -

- 1) De-rating factor of 0.13% per  $^{\circ}C$  is applicable for  $T_j$  below  $25^{\circ}C$ .
- 2) Double side cooled, single phase; 50Hz,  $180^{\circ}$  half-sinewave.
- 3) Single side cooled, single phase; 50Hz,  $180^{\circ}$  half-sinewave.
- 4) Double side cooled.
- 5) Half-sinewave,  $125^{\circ}C$   $T_j$  initial.
- 6)  $V_D=67\% V_{DRM}$ ,  $I_{TM}=1000A$ ,  $I_{FG}=2A$ ,  $t_r\leq 0.5\mu s$ ,  $T_{case}=125^{\circ}C$ .
- 7) Rated  $V_{DRM}$ .

**Characteristics**

	PARAMETER	MIN.	TYP.	MAX.	TEST CONDITIONS (Note 1)	UNITS
$V_{TM}$	Maximum peak on-state voltage	-	-	1.28	$I_{TM}=3220A$	V
$V_0$	Threshold voltage	-	-	0.88		V
$r_s$	Slope resistance	-	-	0.124		m $\Omega$
dv/dt	Critical rate of rise of off-state voltage	200	-	-	$V_D=80\% V_{DRM}$ , linear ramp, Gate O/C	V/ $\mu$ s
$I_{DRM}$	Peak off-state current	-	-	150	Rated $V_{DRM}$	mA
$I_{RRM}$	Peak reverse current	-	-	150	Rated $V_{RRM}$	mA
$V_{GT}$	Gate trigger voltage	-	-	3.0	$T_j=25^\circ C$ , $V_D=10V$ , $I_T=3A$	V
$I_{GT}$	Gate trigger current	-	-	300		mA
$I_H$	Holding current	-	-	1000	$T_j=25^\circ C$	mA
$t_{gd}$	Gate controlled turn-on delay time	-	1.0	2.0	$V_D=67\%V_{DRM}$ , $I_{TM}=2000A$ , $di/dt=10A/\mu s$ , $I_{FG}=2A$ , $t_r=0.5\mu s$ , $T_j=25^\circ C$	$\mu$ s
$t_{gt}$	Turn-on time	-	1.5	2.5		
$Q_{rr}$	Recovered Charge	-	2200	-		$\mu$ C
$Q_{ra}$	Recovered Charge, 50% chord	-	1300	1800	$I_{TM}=1000A$ , $t_p=1000\mu s$ , $di/dt=10A/\mu s$ , $V_r=50V$	$\mu$ C
$I_{rm}$	Reverse recovery current	-	100	-		A
$t_{rr}$	Reverse recovery time, 50% chord	-	20.0	-		$\mu$ s
$t_q$	Turn-off time	-	500	800	$I_{TM}=1000A$ , $t_p=1000\mu s$ , $di/dt=10A/\mu s$ , $V_r=50V$ , $V_{dr}=33\%V_{DRM}$ , $dV_{dr}/dt=20V/\mu s$	$\mu$ s
		-	800	1200	$I_{TM}=1000A$ , $t_p=1000\mu s$ , $di/dt=10A/\mu s$ , $V_r=50V$ , $V_{dr}=33\%V_{DRM}$ , $dV_{dr}/dt=200V/\mu s$	
$R_{th(j-hs)}$	Thermal resistance, junction to heatsink	-	-	0.017	Double side cooled	K/W
		-	-	0.034	Single side cooled	K/W
F	Mounting force	27	-	34		kN
$W_t$	Weight	-	1.0	-		kg

Notes: -

1) Unless otherwise indicated  $T_j=125^\circ C$ .

**Notes on Ratings and Characteristics****1.0 Voltage Grade Table**

Voltage Grade	$V_{DRM}$ $V_{DSM}$ $V_{RRM}$ V	$V_{RSM}$ V	$V_D$ $V_R$ DC V
12	1200	1300	810
14	1400	1500	930
16	1600	1700	1040

**2.0 Extension of Voltage Grades**

This report is applicable to other and higher voltage grades when supply has been agreed by Sales/Production.

**3.0 De-rating Factor**

A blocking voltage de-rating factor of 0.13%/°C is applicable to this device for  $T_j$  below 25°C.

**4.0 Repetitive dv/dt**

Standard dv/dt is 1000V/μs.

**5.0 Rate of rise of on-state current**

The maximum un-primed rate of rise of on-state current must not exceed 300A/μs at any time during turn-on on a non-repetitive basis. For repetitive performance, the on-state rate of rise of current must not exceed 150A/μs at any time during turn-on. Note that these values of rate of rise of current apply to the total device current including that from any local snubber network.

**6.0 Gate Drive**

The recommended pulse gate drive is 30V, 15Ω with a short-circuit current rise time of not more than 0.5μs. This gate drive must be applied when using the full di/dt capability of the device.

The pulse duration may need to be configured according to the application but should be no shorter than 20μs, otherwise an increase in pulse current may be needed to supply the necessary charge to trigger.

**7.0 Computer Modelling Parameters****7.1 Device Dissipation Calculations**

$$I_{AV} = \frac{-V_0 + \sqrt{V_0^2 + 4 \cdot ff^2 \cdot r_s \cdot W_{AV}}}{2 \cdot ff^2 \cdot r_s} \quad \text{and:} \quad W_{AV} = \frac{\Delta T}{R_{th}}$$

$$\Delta T = T_{j\max} - T_{Hs}$$

Where  $V_0=0.88V$ ,  $r_s=0.124m\Omega$ ,

$R_{th}$  = Supplementary thermal impedance, see table below.

$ff$  = Form factor, see table below.

Supplementary Thermal Impedance							
Conduction Angle	30°	60°	90°	120°	180°	270°	d.c.
Square wave Double Side Cooled	0.0263	0.0237	0.022	0.0207	0.0192	0.0179	0.0171
Square wave Single Side Cooled	0.0438	0.0418	0.040	0.038	0.0367	0.0357	0.034
Sine wave Double Side Cooled	0.0238	0.021	0.0196	0.0187	0.0169		
Sine wave Single Side Cooled	0.0426	0.0396	0.0382	0.0373	0.0356		

Form Factors							
Conduction Angle	30°	60°	90°	120°	180°	270°	d.c.
Square wave	3.46	2.45	2	1.73	1.41	1.15	1
Sine wave	3.98	2.78	2.22	1.88	1.57		

7.2 Calculating  $V_T$  using ABCD Coefficients

The on-state characteristic  $I_T$  vs.  $V_T$ , on page 5 is represented in two ways;

- (i) the well established  $V_0$  and  $r_s$  tangent used for rating purposes and
- (ii) a set of constants A, B, C, D, forming the coefficients of the representative equation for  $V_T$  in terms of  $I_T$  given below:

$$V_T = A + B \cdot \ln(I_T) + C \cdot I_T + D \cdot \sqrt{I_T}$$

The constants, derived by curve fitting software, are given below for both hot and cold characteristics. The resulting values for  $V_T$  agree with the true device characteristic over a current range, which is limited to that plotted.

125°C Coefficients	
A	0.592114202
B	$-7.608075 \times 10^{-3}$
C	$6.807 \times 10^{-5}$
D	$9.342666 \times 10^{-3}$

7.3 D.C. Thermal Impedance Calculation

$$r_t = \sum_{p=1}^{p=n} r_p \cdot \left( 1 - e^{-\frac{t}{\tau_p}} \right)$$

Where  $p = 1$  to  $n$ ,  $n$  is the number of terms in the series and:

- $t$  = Duration of heating pulse in seconds.
- $r_t$  = Thermal resistance at time  $t$ .
- $r_p$  = Amplitude of  $p_{th}$  term.
- $\tau_p$  = Time Constant of  $r_{th}$  term.

D.C. Double Side Cooled				
Term	1	2	3	4
$r_p$	$8.74 \times 10^{-3}$	$5.08 \times 10^{-3}$	$1.80 \times 10^{-3}$	$1.54 \times 10^{-3}$
$\tau_p$	1.328	0.157	0.0242	$2.3 \times 10^{-3}$

D.C. Single Side Cooled							
Term	1	2	3	4	5	6	7
$r_p$	0.0204	$4.47 \times 10^{-3}$	$2.66 \times 10^{-3}$	$4.62 \times 10^{-3}$	$1.50 \times 10^{-3}$	$1.08 \times 10^{-3}$	$1.29 \times 10^{-3}$
$\tau_p$	9.877	5.385	0.781	0.161	0.0524	0.0106	$1.77 \times 10^{-3}$

8.0 Reverse recovery ratings

- (i)  $Q_{ra}$  is based on 50%  $I_{rm}$  chord as shown in Fig. 1.
- (ii)  $Q_{rr}$  is based on a 150µs integration time.

i.e. 
$$Q_{rr} = \int_0^{150\mu s} i_{rr} \cdot dt$$

(iii) 
$$K \text{ Factor} = \frac{t1}{t2}$$

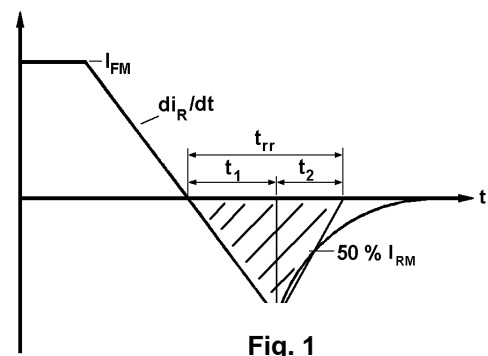

**Curves**

Figure 1 - On-state characteristics of Limit device

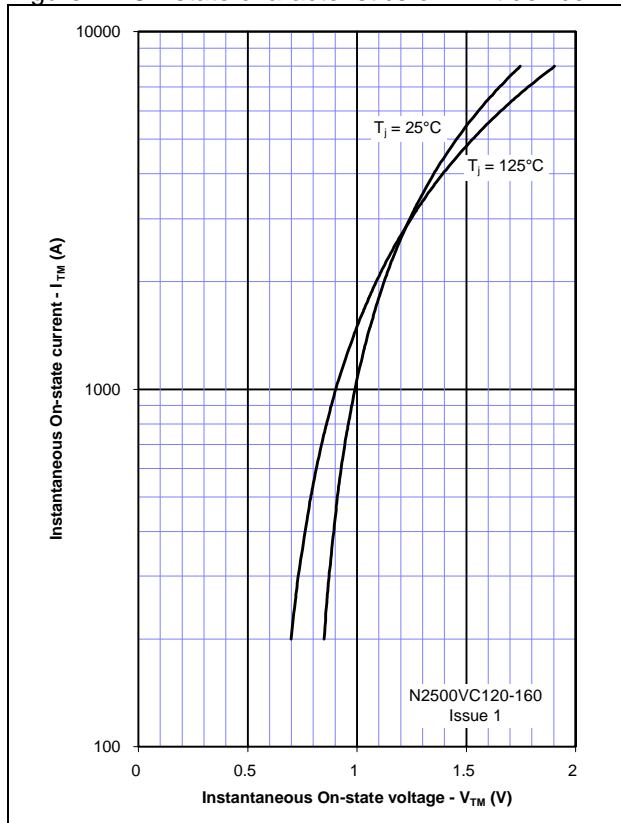

Figure 2 - Transient Thermal Impedance

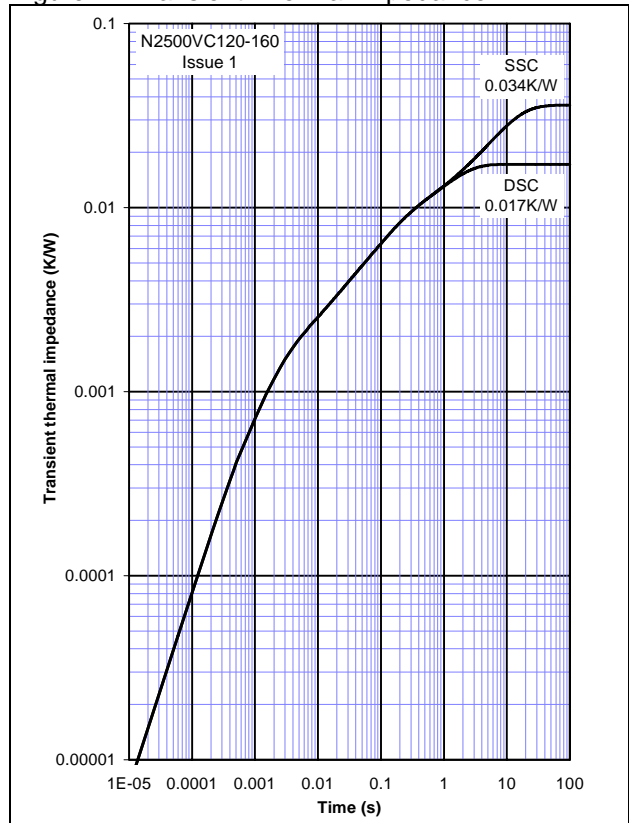

Figure 3 - Gate Characteristics - Trigger Limits

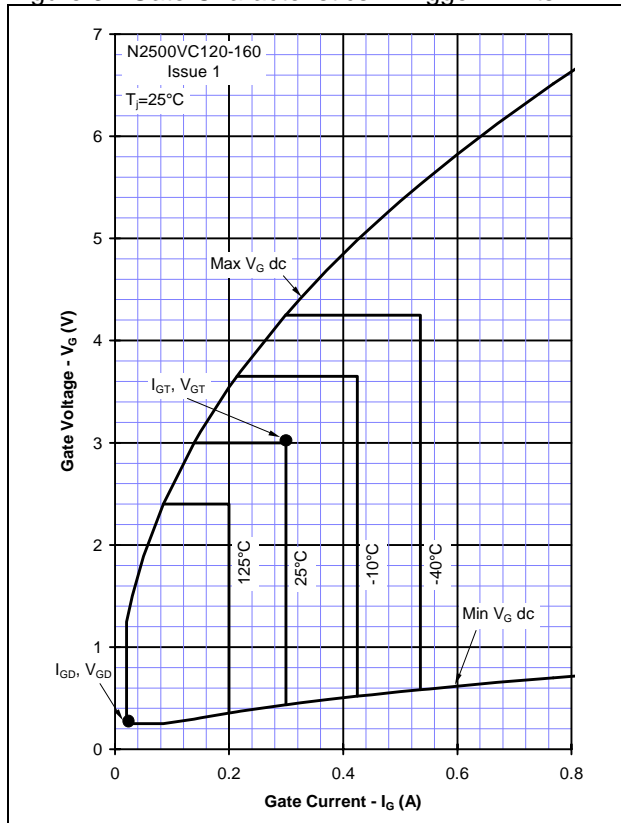

Figure 4 - Gate Characteristics - Power Curves

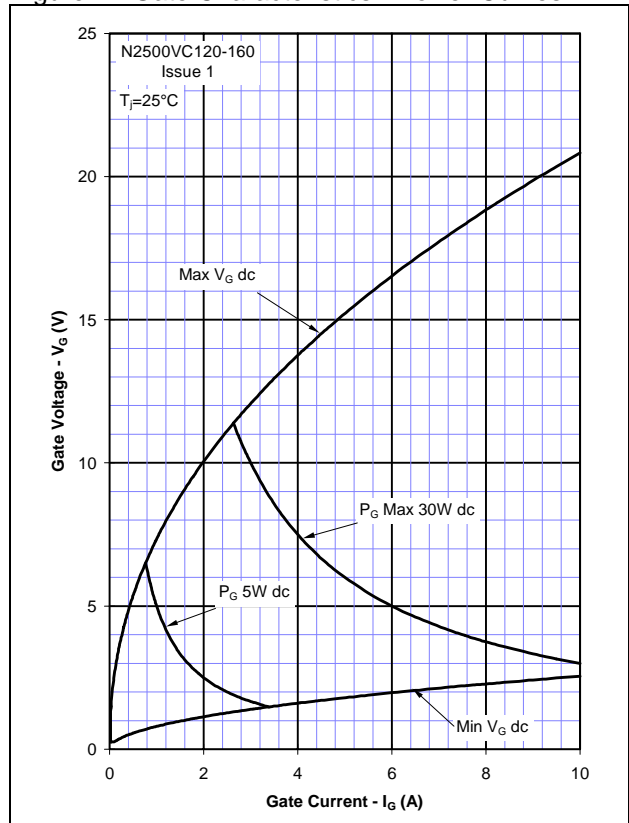

Figure 5 – Recovered Charge,  $Q_{rr}$

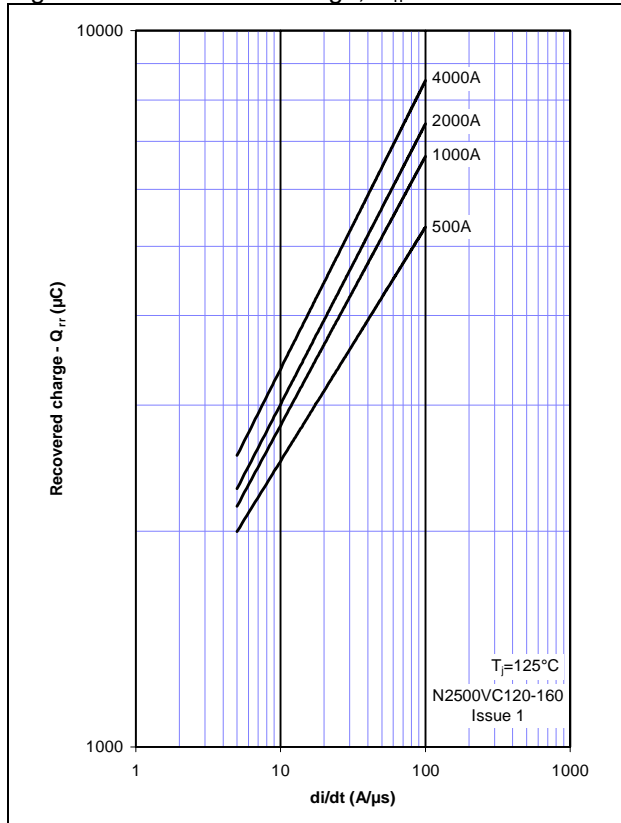

Figure 6 – Recovered charge,  $Q_{ra}$  (50% chord)

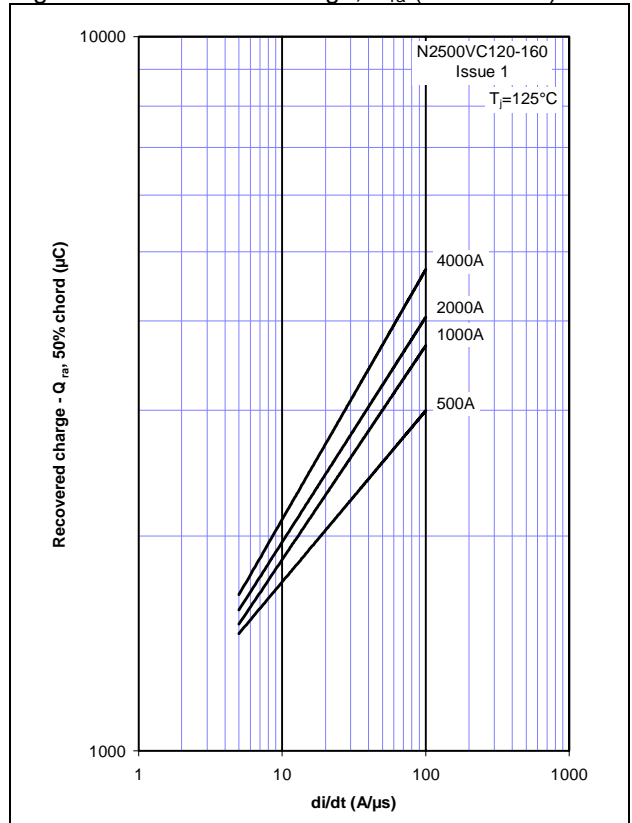

Figure 7 – Reverse recovery current,  $I_{rm}$

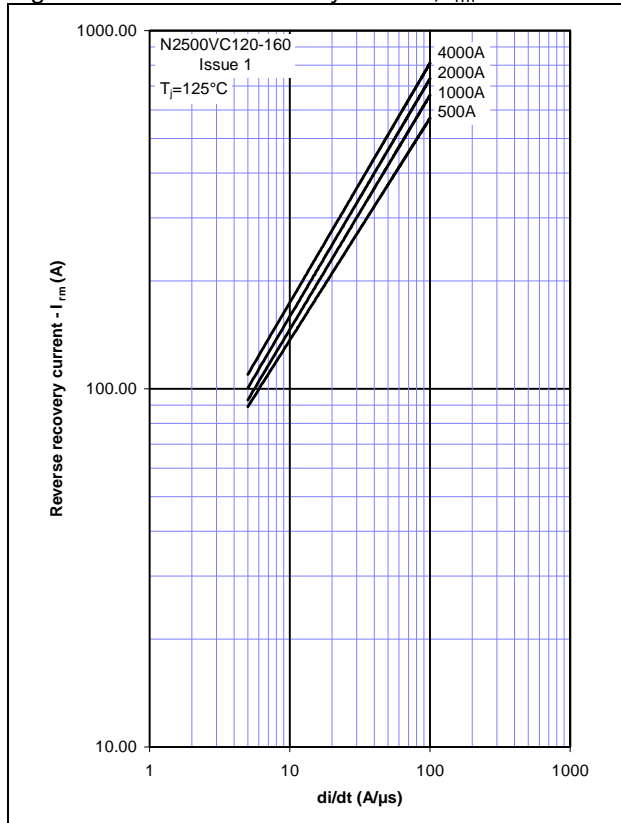

Figure 8 – Reverse recovery time,  $t_{rr}$  (50% chord)

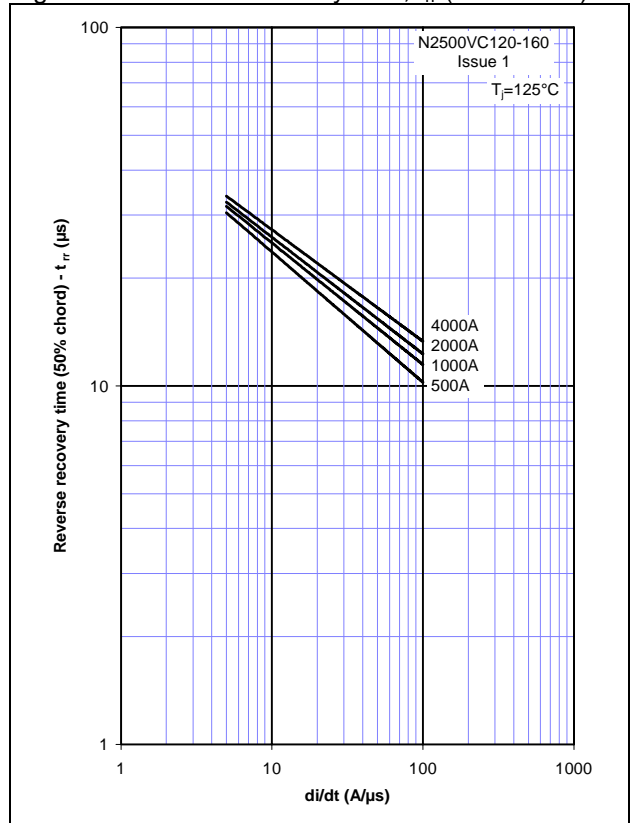

Figure 9 – On-state current vs. Power dissipation – Double Side Cooled (Sine wave)

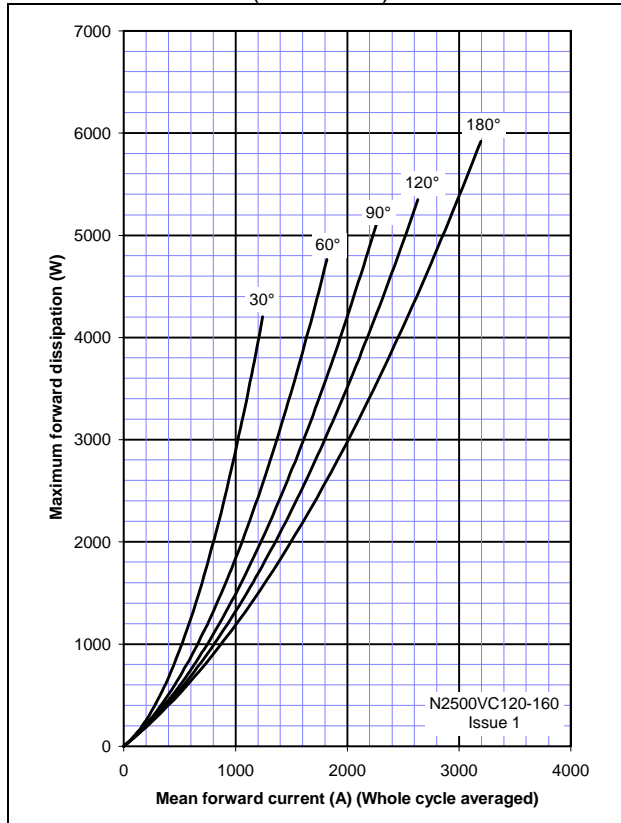

Figure 10 – On-state current vs. Heatsink temperature - Double Side Cooled (Sine wave)

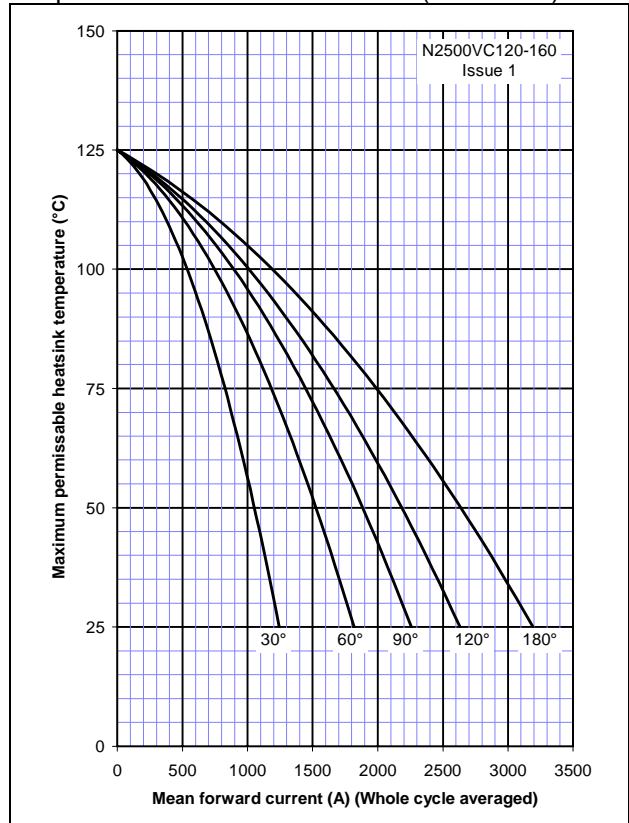

Figure 11 – On-state current vs. Power dissipation – Double Side Cooled (Square wave)

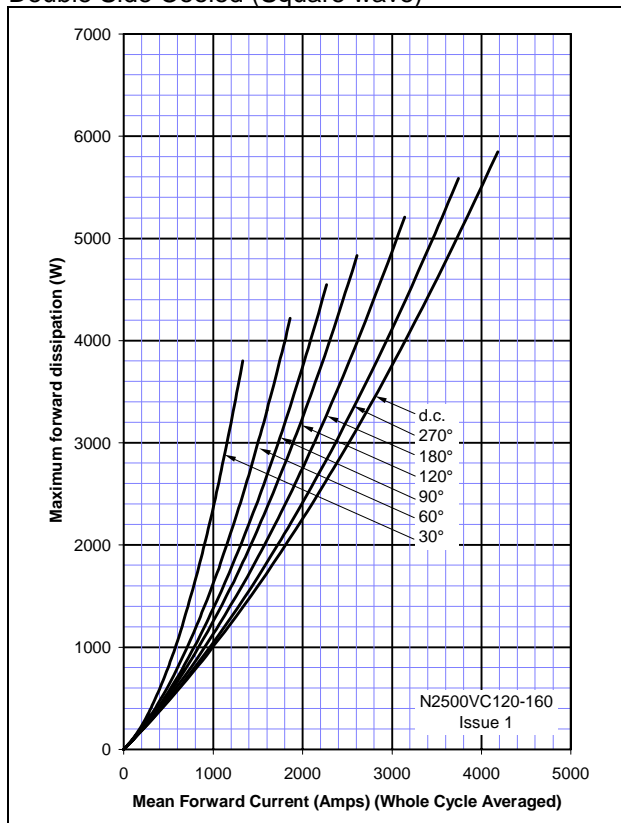

Figure 12 – On-state current vs. Heatsink temperature - Double Side Cooled (Square wave)

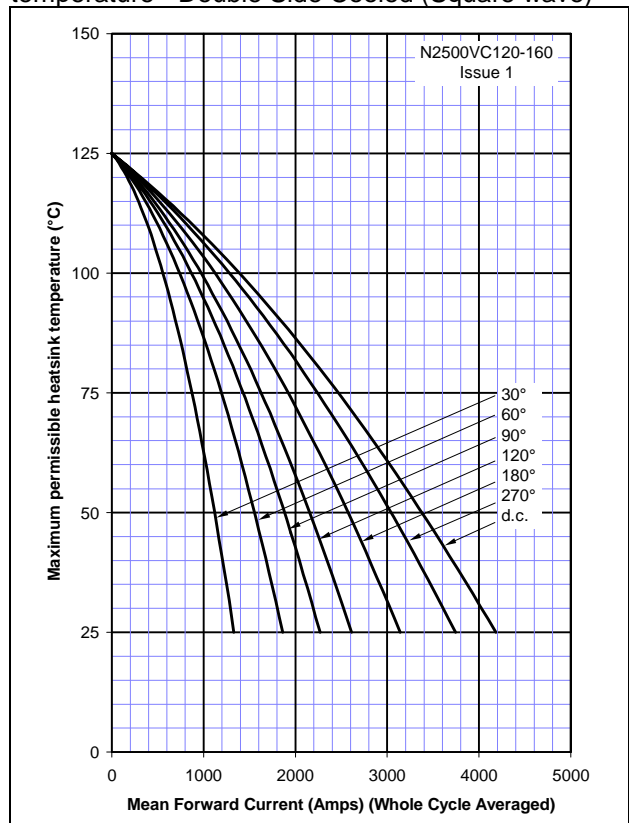

Figure 13 – On-state current vs. Power dissipation – Single Side Cooled (Sine wave)

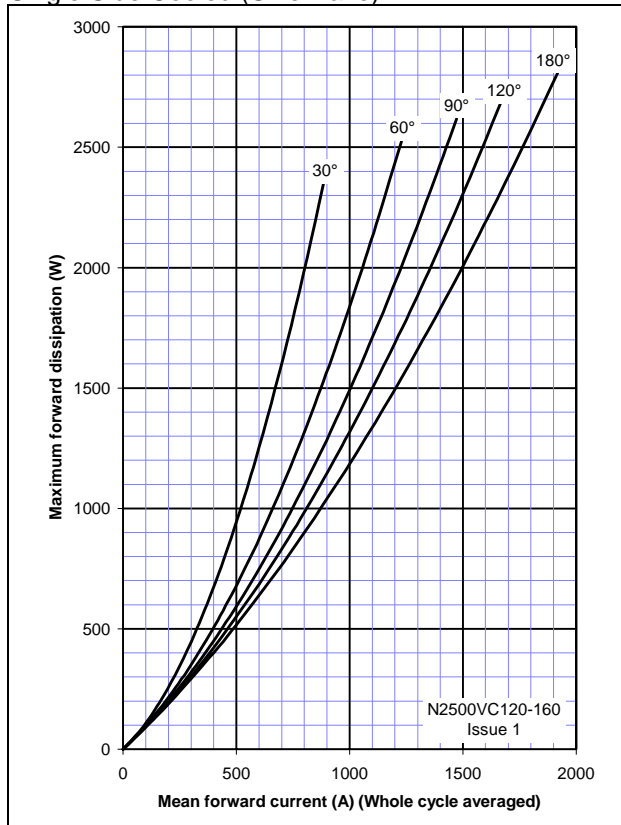

Figure 14 – On-state current vs. Heatsink temperature - Single Side Cooled (Sine wave)

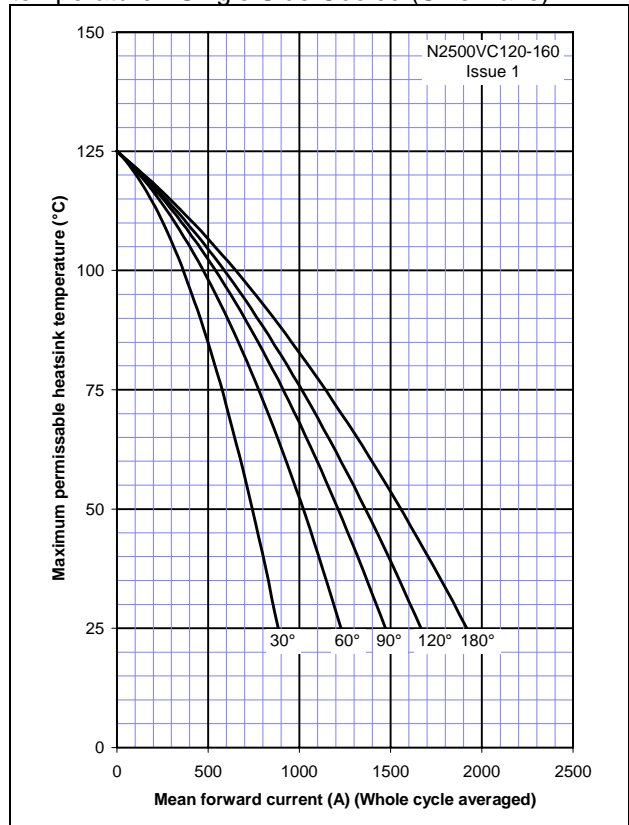

Figure 15 – On-state current vs. Power dissipation – Single Side Cooled (Square wave)

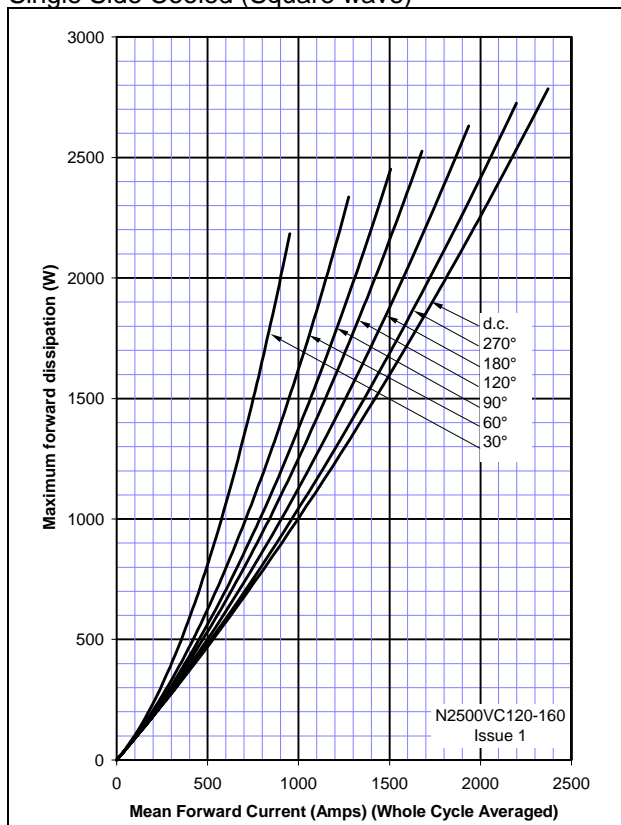

Figure 16 – On-state current vs. Heatsink temperature - Single Side Cooled (Square wave)

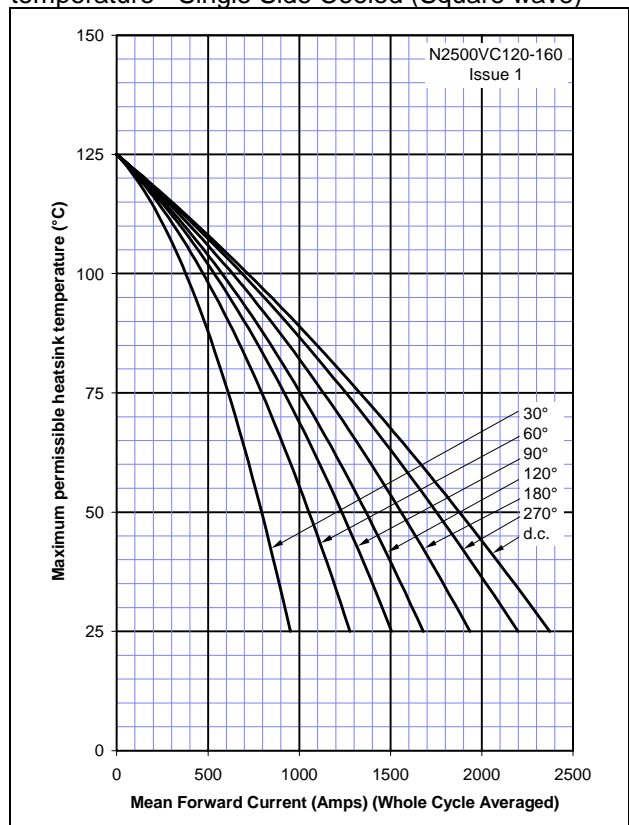
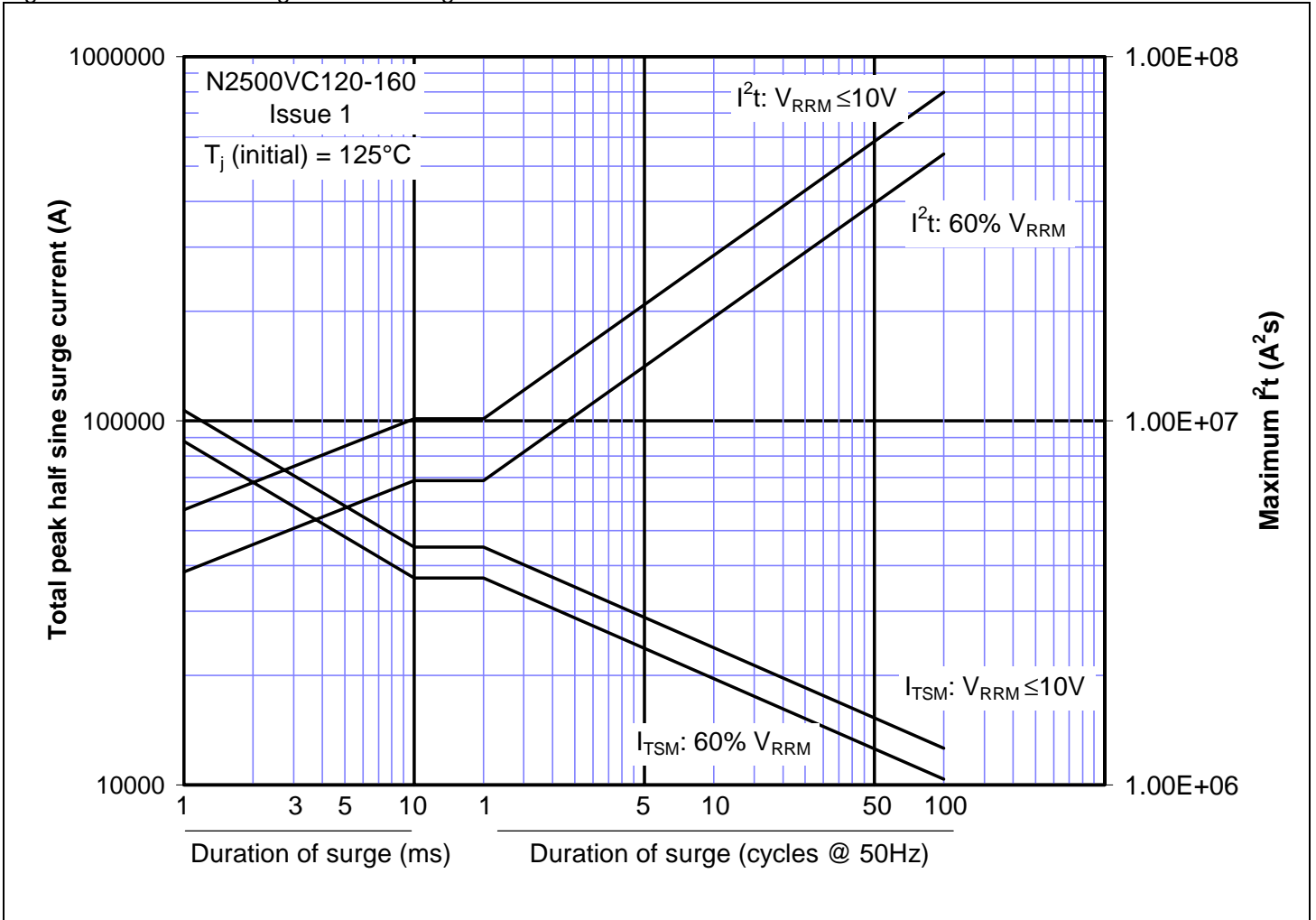
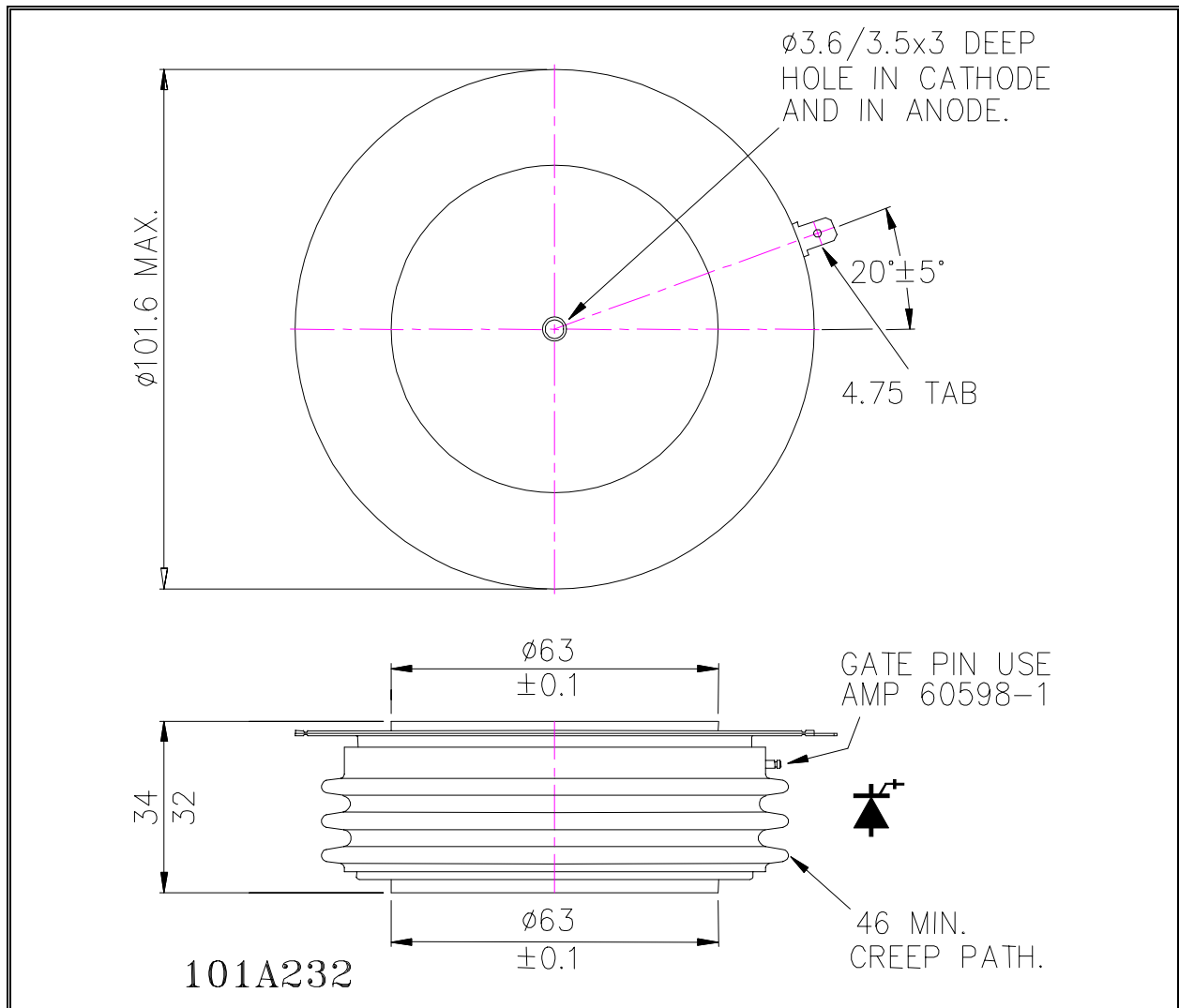



Figure 17 – Maximum surge and  $I^2t$  Ratings



**Outline Drawing & Ordering Information**



ORDERING INFORMATION		(Please quote 10 digit code as below)	
<b>N2500</b>	<b>VC</b>	<b>◆◆</b>	<b>0</b>
Fixed Type Code	Fixed Outline Code	Voltage Code 12-16	Fixed turn-off time code

Typical order code: N2500VC120 – 1200V  $V_{DRM}/V_{RRM}$ , 34mm clamp height capsule.

**WESTCODE**

UK: Westcode Semiconductors Ltd.  
 P.O. Box 57, Chippenham, Wiltshire, England. SN15 1JL.  
 Tel: +44 (0) 1249 444524 Fax: +44 (0) 1249 659448  
 E-Mail: [WSL.sales@westcode.com](mailto:WSL.sales@westcode.com)

USA: Westcode Semiconductors Inc.  
 3270 Cherry Avenue, Long Beach, California 90807  
 Tel: +1 (562) 595 6971 Fax: +1 (562) 595 8182  
 E-Mail: [WSI.sales@westcode.com](mailto:WSI.sales@westcode.com)

Internet: <http://www.westcode.com>

The information contained herein is confidential and is protected by Copyright. The information may not be used or disclosed except with the written permission of and in the manner permitted by the proprietors Westcode Semiconductors Ltd.

© Westcode Semiconductors Ltd.

In the interest of product improvement, Westcode reserves the right to change specifications at any time without prior notice.

Devices with a suffix code (2-letter or letter/digit/letter combination) added to their generic code are not necessarily subject to the conditions and limits contained in this report.