



Key Parameters

$I_{F(AV)M}$	=	89	A
V_{RRM}	=	1600	V
I_{FSM}	=	2800	A
V_{T0}	=	0.75	V
r_T	=	2.3	mΩ

Properties

- International standard package
- High operation reliability
- Electrically insulated base plate

MAXIMUM ALLOWABLE RATINGS

Symbols and parameters			Maximum Limits	Unit
V_{RRM}	Repetitive peak reverse voltage	$T_{vj} = -40^{\circ}\text{C} \dots T_{vj \text{ max}}$	1600	V
V_{RSM}	Non-repetitive peak reverse voltage	$T_{vj} = +25^{\circ}\text{C} \dots T_{vj \text{ max}}$	1700	V
I_{FAVM}	Average on-state current	$T_C = 100^{\circ}\text{C}$	89	A
I_{FRMSM}	Maximum RMS on-state current		140	A
I_{FSM}	Surge current	$T_{vj} = 25^{\circ}\text{C}, t_p = 10 \text{ ms}$	2800	A
		$T_{vj} = T_{vj \text{ max}}, t_p = 10 \text{ ms}$	2400	A
I^2t	Safety factor	$T_{vj} = 25^{\circ}\text{C}, t_p = 10 \text{ ms}$	39200	A ² s
		$T_{vj} = T_{vj \text{ max}}, t_p = 10 \text{ ms}$	28800	A ² s

CHARACTERISTICS

Symbols and parameters			Value			Unit
			min	typ	max	
V_F	On-state voltage	$T_{vj} = T_{vj \text{ max}}, I_F = 300 \text{ A}$			1.5	V
$V_{(T0)}$	Threshold voltage	$T_{vj} = T_{vj \text{ max}}$			0.75	V
r_T	Slope resistance	$T_{vj} = T_{vj \text{ max}}$			2.3	mΩ

I_R	Reverse current	$T_{vj} = T_{vj\ max}, V_R = V_{RRM}$			20	mA
V_{ISOL}	Insulation test voltage	RMS, f = 50Hz, t = 1 sec RMS, f = 50Hz, t = 1 min			3.0 2.5	kV

THERMAL PARAMETERS

Symbols and parameters			Value	Unit
R_{th(j-c)}	Thermal resistance, junction to case	per Module, $\theta = 180^\circ$ sin	0.225	°C/W
		per arm, $\theta = 180^\circ$ sin	0.450	
		per Module, DC	0.215	
		per arm, DC	0.430	
R_{th(c-h)}	Thermal resistance, case to heatsink	per Module	0.05	°C/W
		per arm	0.10	
T_{vj max}	Maximum junction temperature		+150	°C
T_{C op}	Operating temperature range		-40...+150	°C
T_{stg}	Storage temperature range		-40...+150	°C

MECHANICAL PARAMETERS

Symbols and parameters			Value	Unit
M1	Mounting torque	Tolerance $\pm 15\%$	4	Nm
M2	Terminal connection torque	Tolerance $\pm 10\%$	4	Nm
W	Weight		160	g
a	Vibration resistance	f = 50 Hz	50	m/s ²

DIMENSIONS

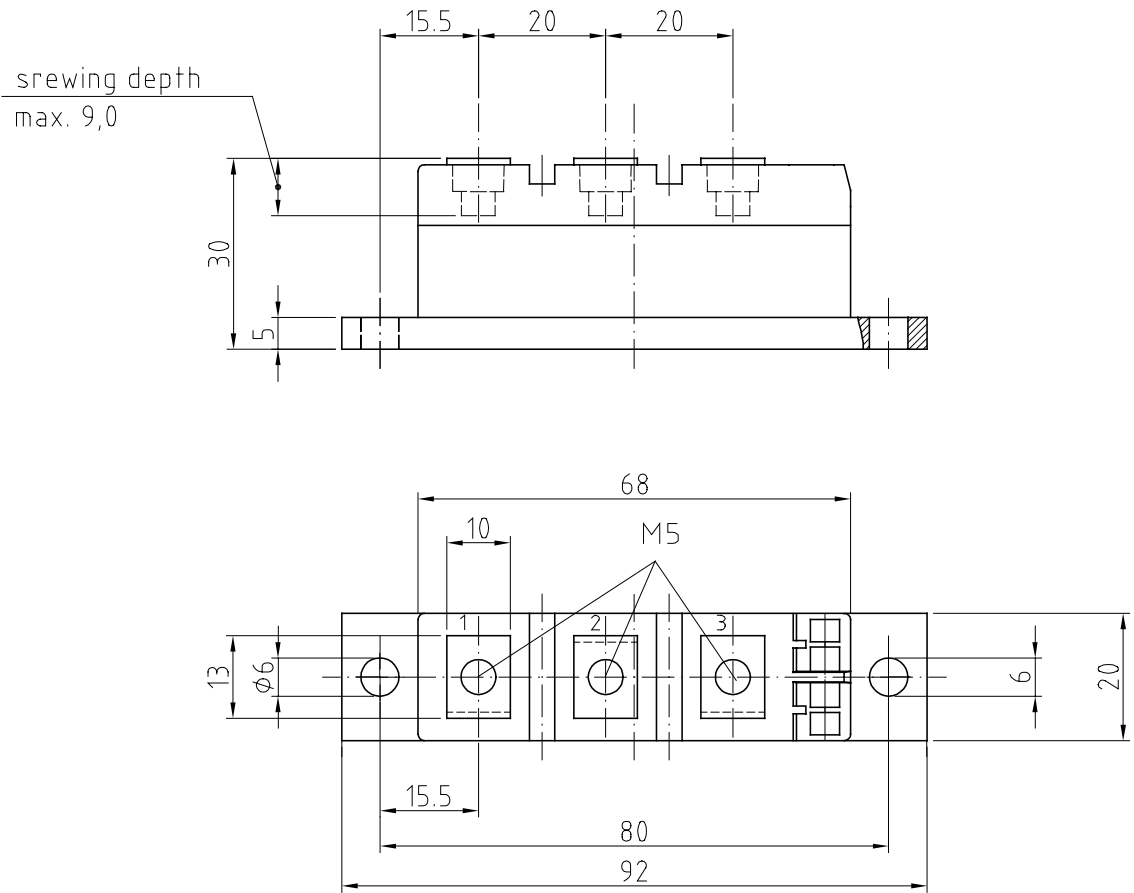

TOPOLOGY OF INTERNAL CONNECTION

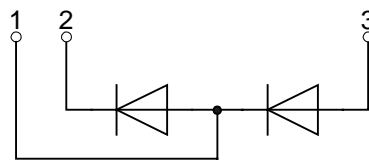

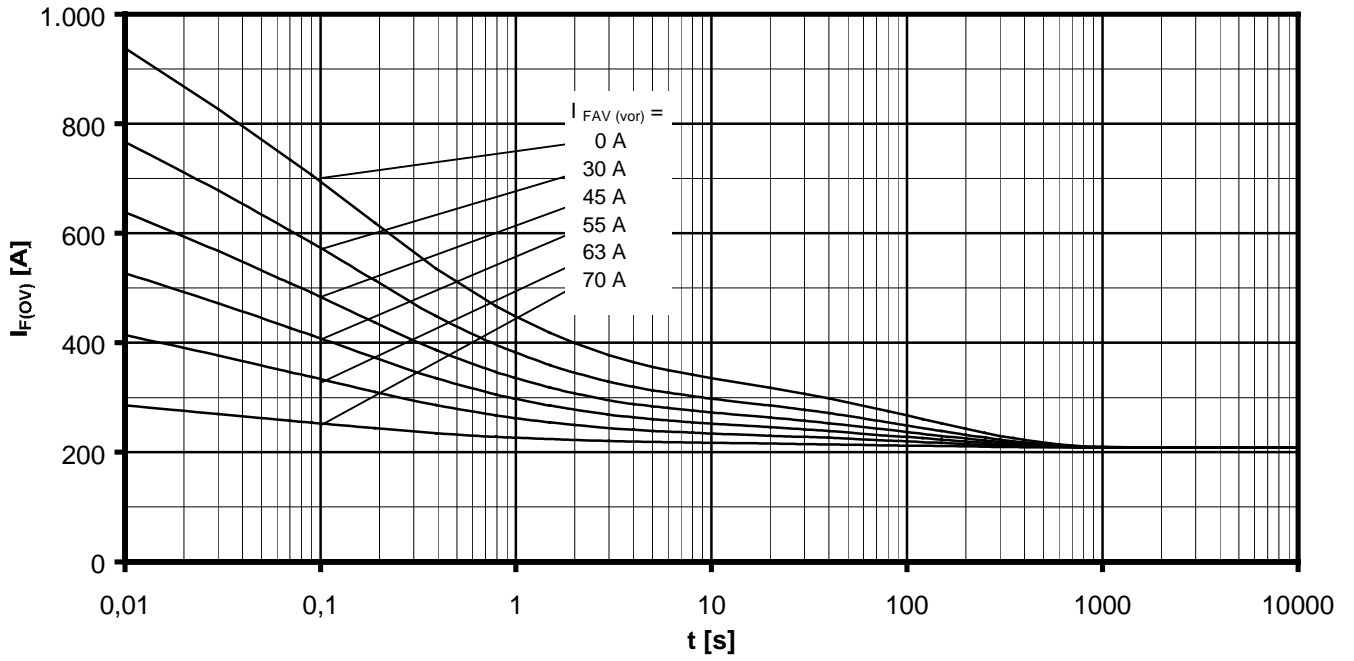

Overload on-state current $I_{F(ov)}$

B6- Six-pulse bridge circuit 120° rectangular Heatsink type KM14 (Papst 4650)

Forced cooling at $T_A = 35^\circ\text{C}$

Parameter: Pre-load current per arm $I_{FAV(vor)}$

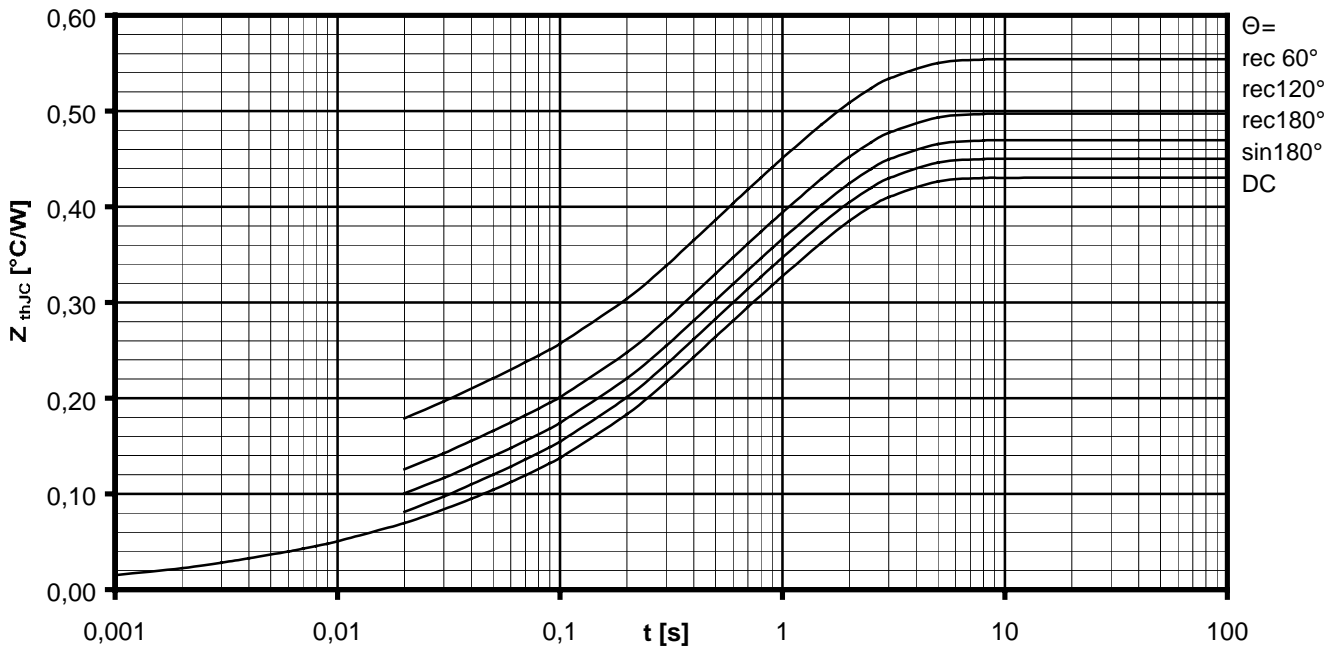

Transient thermal impedance per arm $Z_{thJC} = f(t)$

Parameter: Current conduction angle Θ

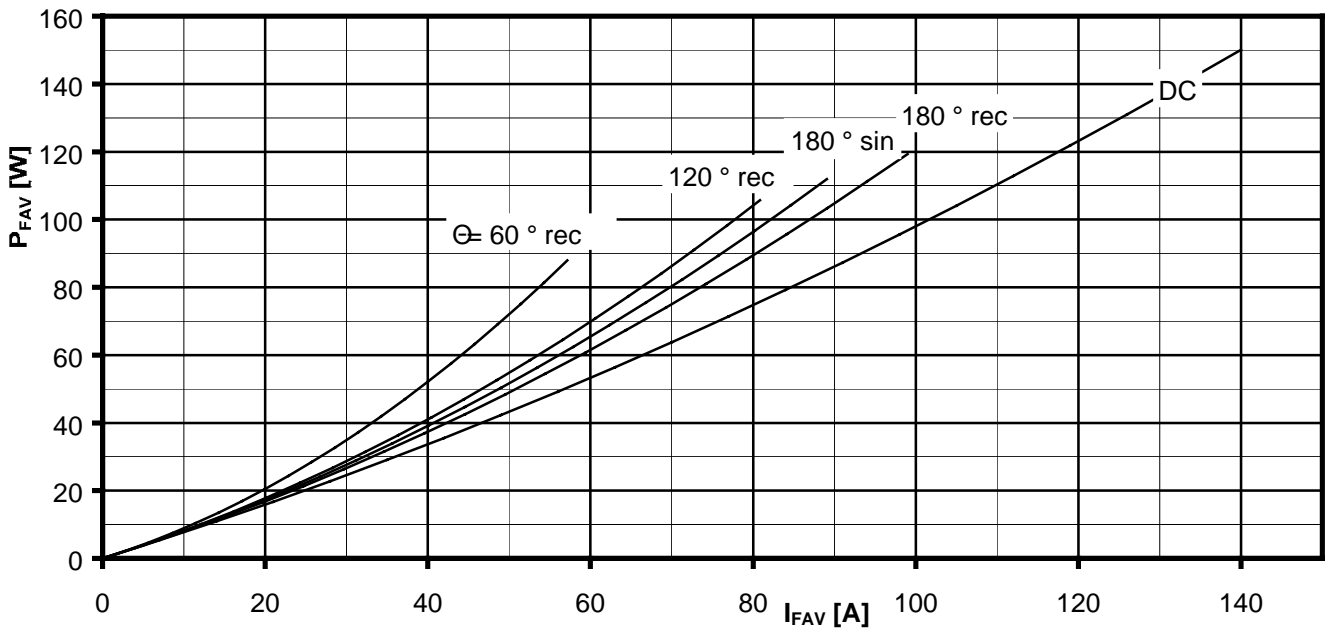

On-state power loss per arm $P_{FAV} = f(I_{FAV})$

Parameter: Current conduction angle Θ

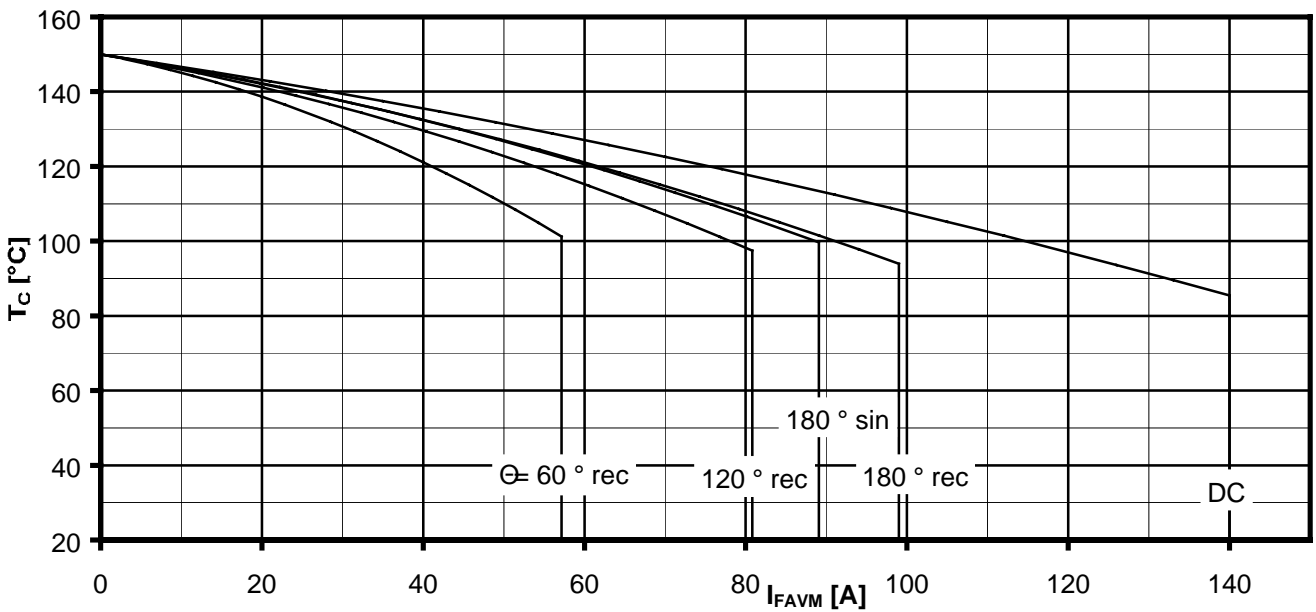

Maximum allowable case temperature $T_C = f(I_{FAVM})$

Current load per arm

Calculation base P_{TAV}

Parameter: Current conduction angle Θ

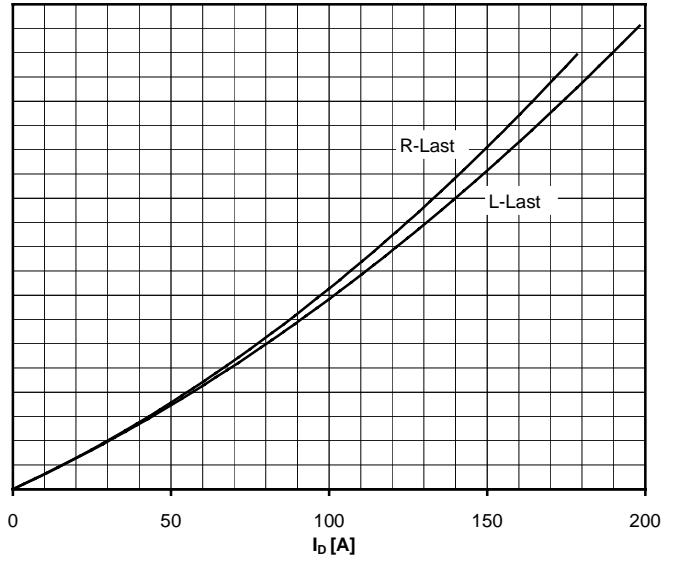
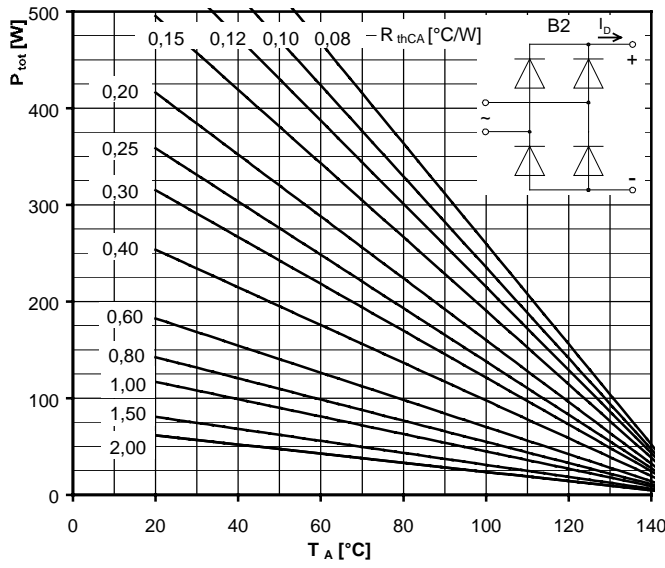

Maximum rated output current I_b

B2- Two-pulse bridge circuit

Total power dissipation at circuit P_{tot}

Parameter:

Thermal resistance cases to ambient R_{thCA}

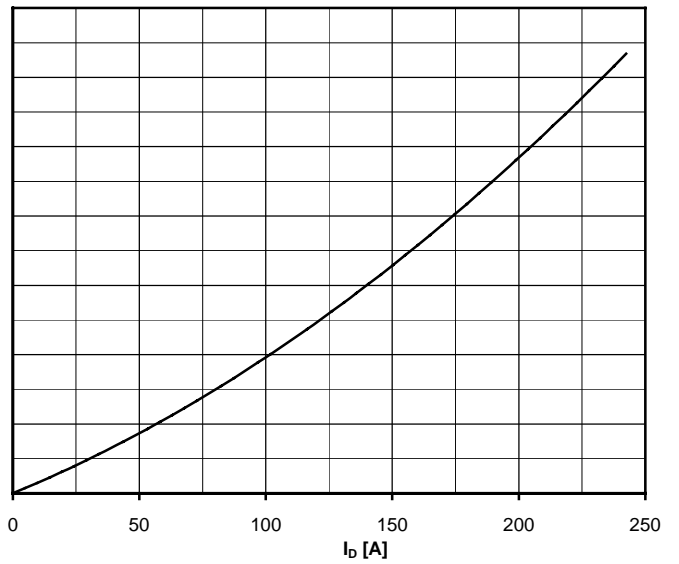
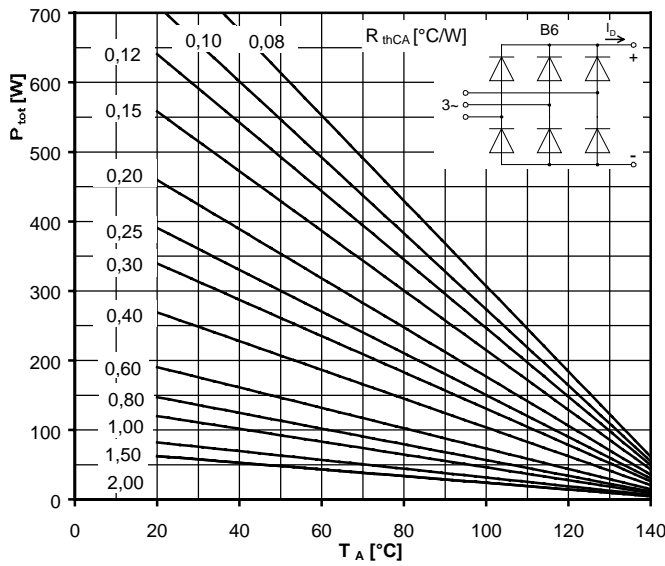

Maximum rated output current I_b

B6- Six-pulse bridge circuit

Total power dissipation at circuit P_{tot}

Parameter:

Thermal resistance cases to ambient R_{thCA}

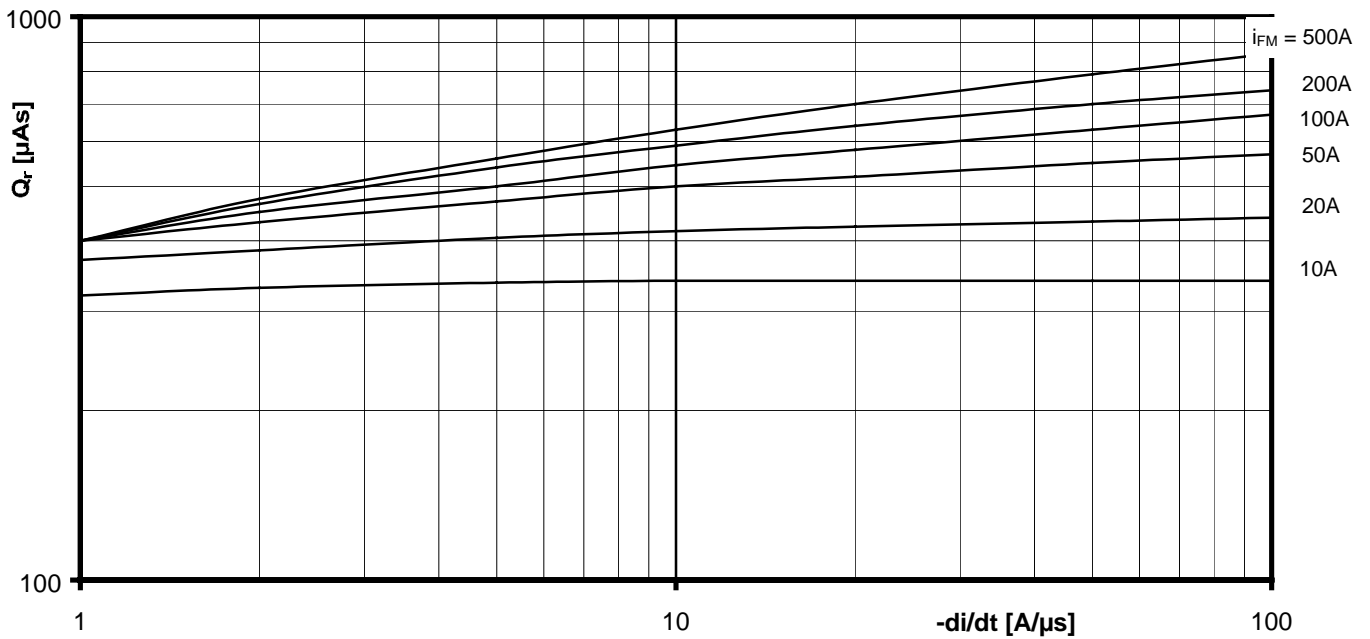

Recovered charge $Q_r = f(-di/dt)$

$T_{vj} = T_{vjmax}$, $V_R \leq 0,5 V_{RRM}$, $V_{RM} = 0,8 V_{RRM}$

Parameter: On-state current i_{FM}

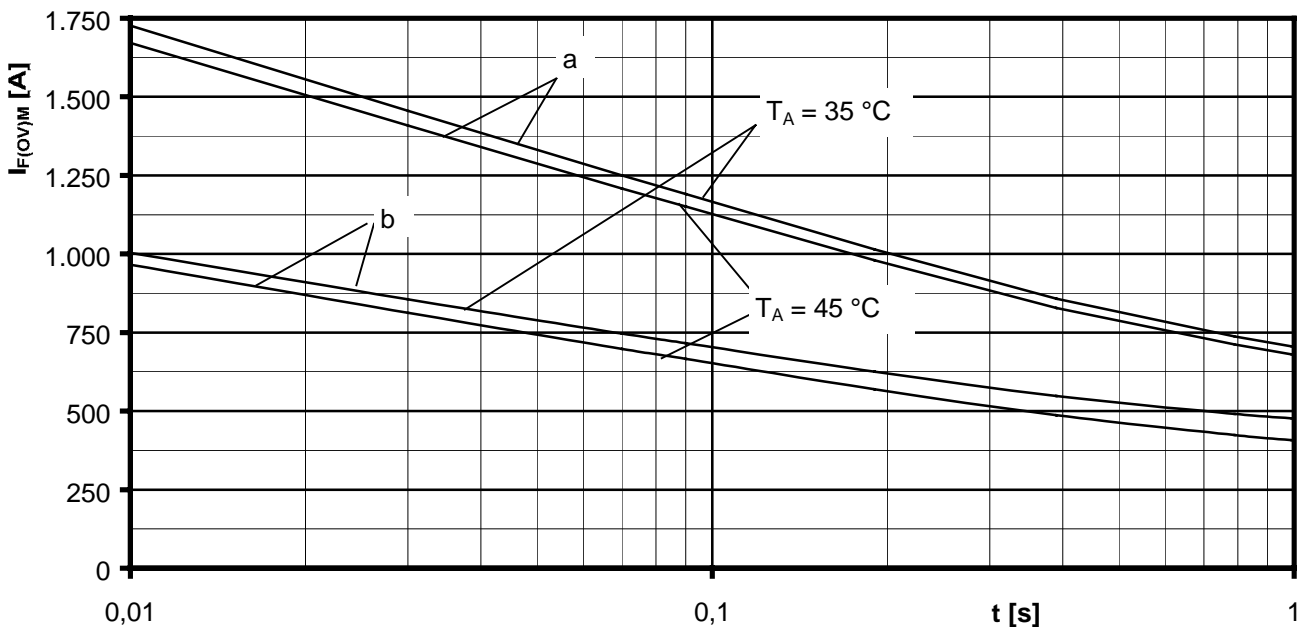

Maximum overload on-state current per arm $I_{F(OV)M} = f(t)$, $V_{RM} = 0,8 V_{RRM}$

a: No-load conditions

b: Pre-load current per arm $I_{FAV(vor)} = I_{FAVM}$

$T_a = 35^\circ\text{C}$, Forced air cooling Heatsink type: KM14 (Papst 4650)

$T_a = 45^\circ\text{C}$, Natural air cooling Heatsink type: KM14 (50W)

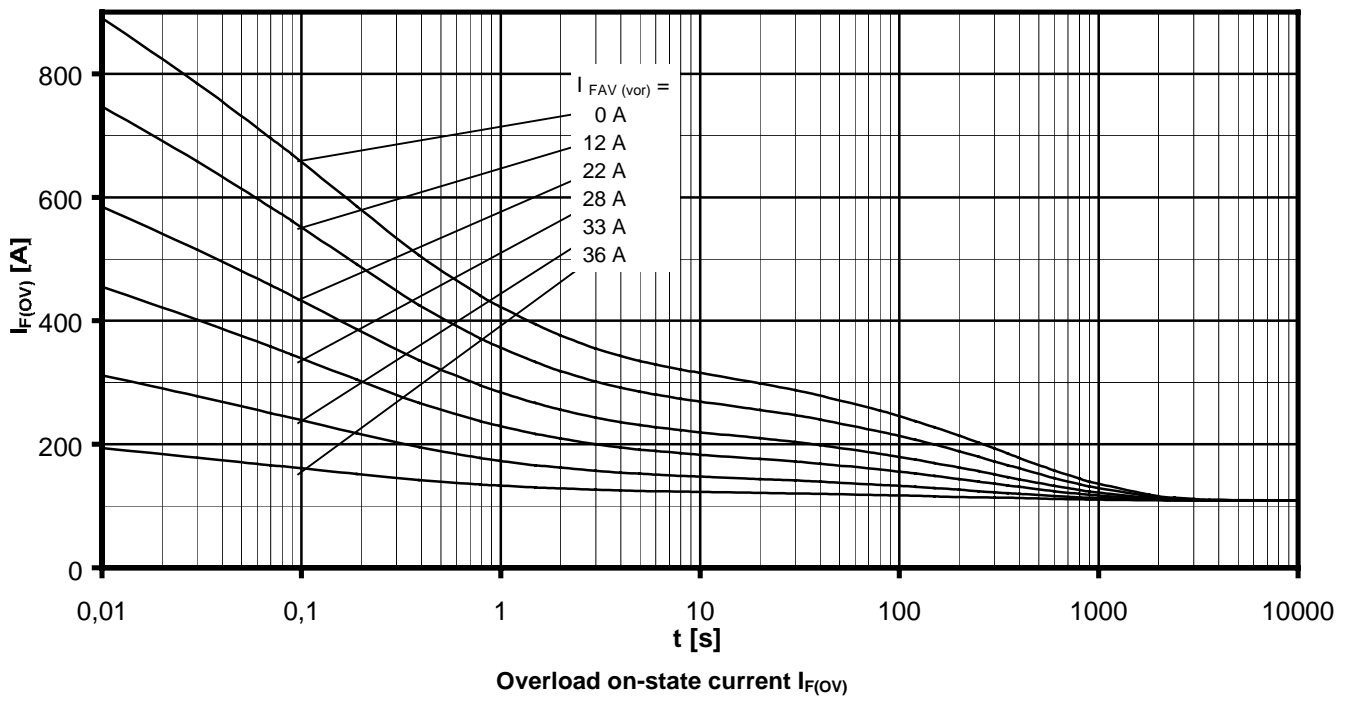

B6- Six-pulse bridge circuit, 120° rectangular Heatsink type KM14 (50W)

Natural cooling at $T_A = 45^\circ\text{C}$

Parameter: Pre-load current per arm $I_{FAV(vor)}$