

Diode Module AMDD175N32K



Key Parameters

$I_{F(AV)M}$	=	175	A
V_{RRM}	=	3200	V
I_{FSM}	=	4500	A
V_{T0}	=	0.9	V
r_T	=	1.8	mΩ

Properties

- International standard package
- High operation reliability
- Electrically insulated base plate

MAXIMUM ALLOWABLE RATINGS

Symbols and parameters			Maximum Limits	Unit
V_{RRM}	Repetitive peak reverse voltage	$T_{vj} = -40^{\circ}\text{C} \dots T_{vj \text{ max}}$	3200	V
V_{RSM}	Non-repetitive peak reverse voltage	$T_{vj} = +25^{\circ}\text{C} \dots T_{vj \text{ max}}$	3300	V
I_{FAVM}	Average on-state current	$T_C = 100^{\circ}\text{C}$ $T_C = 78^{\circ}\text{C}$	175 223	A
I_{FRMSM}	Maximum RMS on-state current		350	A
I_{FSM}	Surge current	$T_{vj} = 25^{\circ}\text{C}, t_p = 10 \text{ ms}$ $T_{vj} = T_{vj \text{ max}}, t_p = 10 \text{ ms}$	4500 4000	A A
I^2t	Safety factor	$T_{vj} = 25^{\circ}\text{C}, t_p = 10 \text{ ms}$ $T_{vj} = T_{vj \text{ max}}, t_p = 10 \text{ ms}$	101000 80000	A ² s A ² s

CHARACTERISTICS

Symbols and parameters			Value			Unit
			min	typ	max	
V_F	On-state voltage	$T_{vj} = T_{vj \max}, I_F = 600 \text{ A}$			2.05	V
$V_{(TO)}$	Threshold voltage	$T_{vj} = T_{vj \max}$			0.9	V
r_T	Slope resistance	$T_{vj} = T_{vj \max}$			1.8	m Ω
I_R	Reverse current	$T_{vj} = T_{vj \max}, V_R = V_{RRM}$			20	mA
V_{ISOL}	Insulation test voltage	RMS, f = 50Hz, t = 1 sec RMS, f = 50Hz, t = 1 min			3.6 3.0	kV

THERMAL PARAMETERS

Symbols and parameters			Value	Unit
$R_{th(j-c)}$	Thermal resistance, junction to case	per Module, $\theta = 180^\circ \text{ sin}$ per arm, $\theta = 180^\circ \text{ sin}$ per Module, DC per arm, DC	0.085 0.170 0.082 0.164	$^\circ\text{C/W}$
$R_{th(c-h)}$	Thermal resistance, case to heatsink	per Module per arm	0.02 0.04	$^\circ\text{C/W}$
$T_{vj \max}$	Maximum junction temperature		+150	$^\circ\text{C}$
$T_{C \text{ op}}$	Operating temperature range		-40...+150	$^\circ\text{C}$
T_{stg}	Storage temperature range		-40...+150	$^\circ\text{C}$

MECHANICAL PARAMETERS

Symbols and parameters			Value	Unit
M1	Mounting torque	Tolerance $\pm 15\%$	5	Nm
M2	Terminal connection torque	Tolerance $\pm 10\%$	12	Nm
W	Weight		800	g
a	Vibration resistance	f = 50 Hz	50	m/s ²

DIMENSIONS

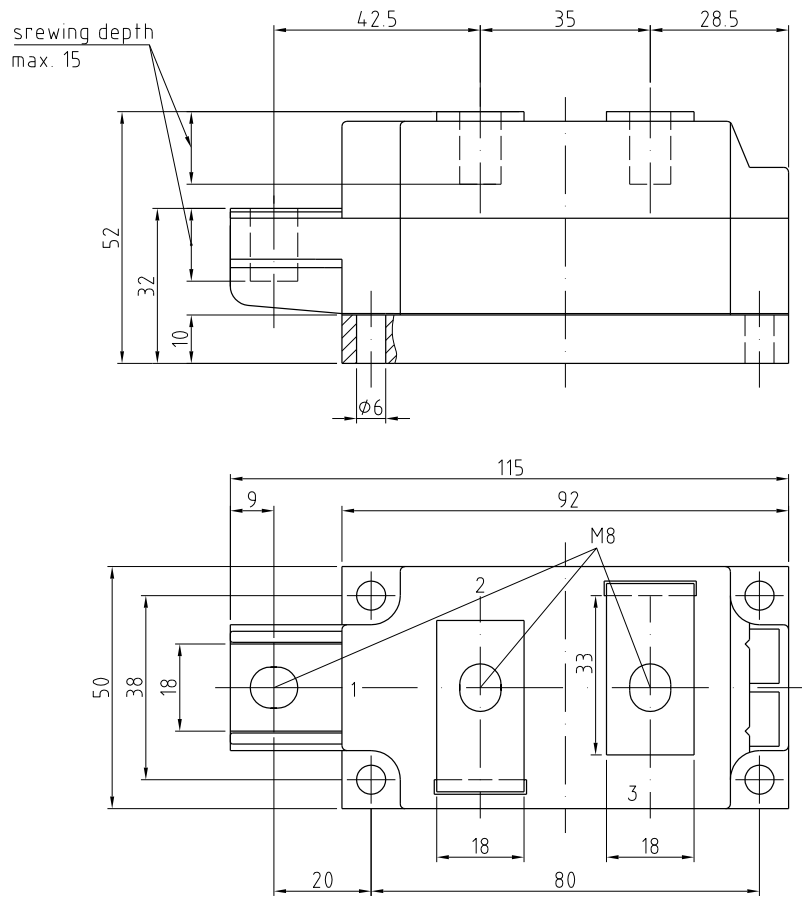

TOPOLOGY OF INTERNAL CONNECTION

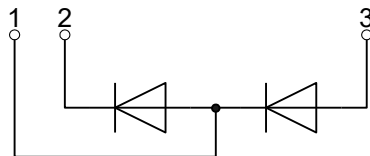

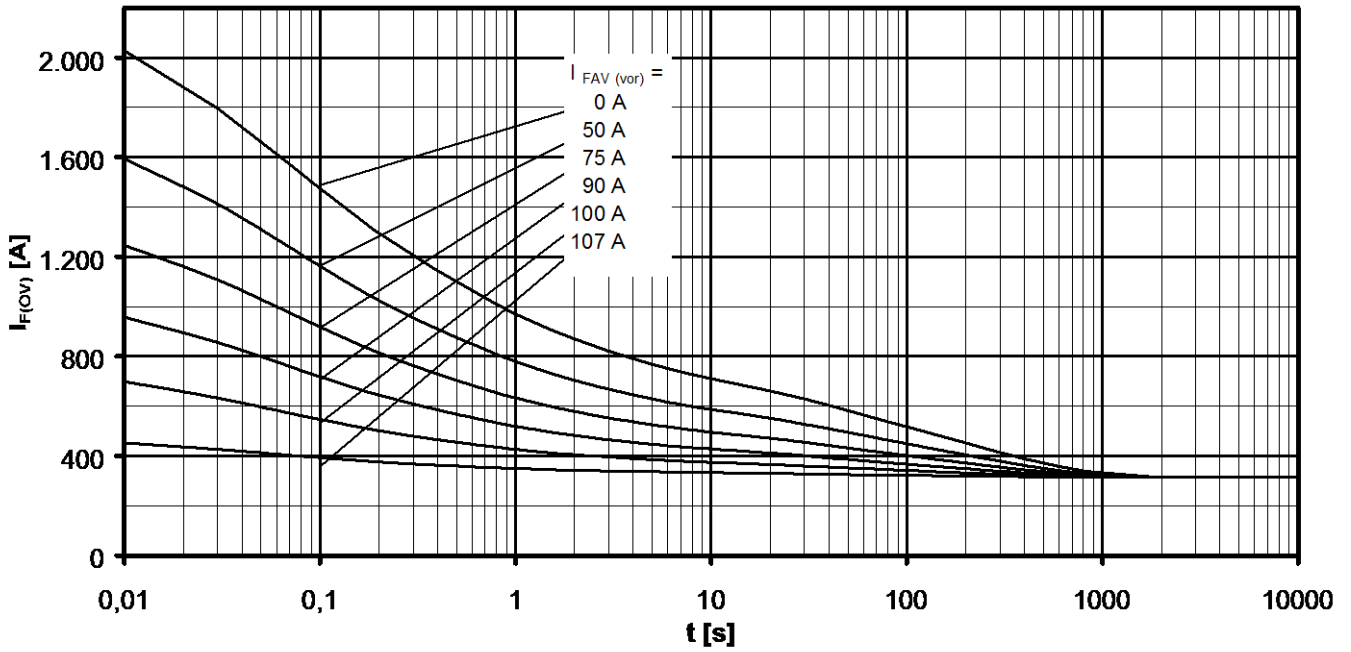

Overload on-state current $I_{F(ov)}$

B6- Six-pulse bridge circuit 120° rectangular Heatsink type KM17 (Papst 4650)

Forced cooling at $T_A = 35^\circ\text{C}$ Parameter: Pre-load current per arm $I_{FAV(vor)}$

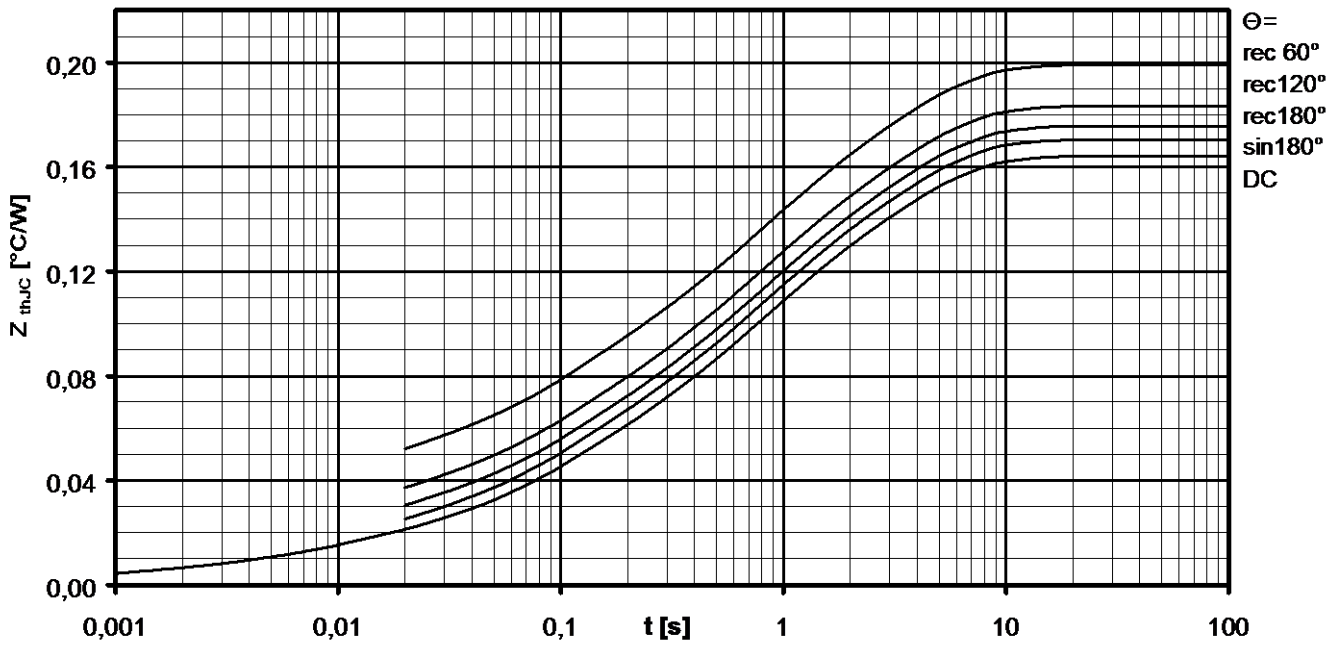

Transient thermal impedance per arm $Z_{thJC} = f(t)$

Parameter: Current conduction angle Θ

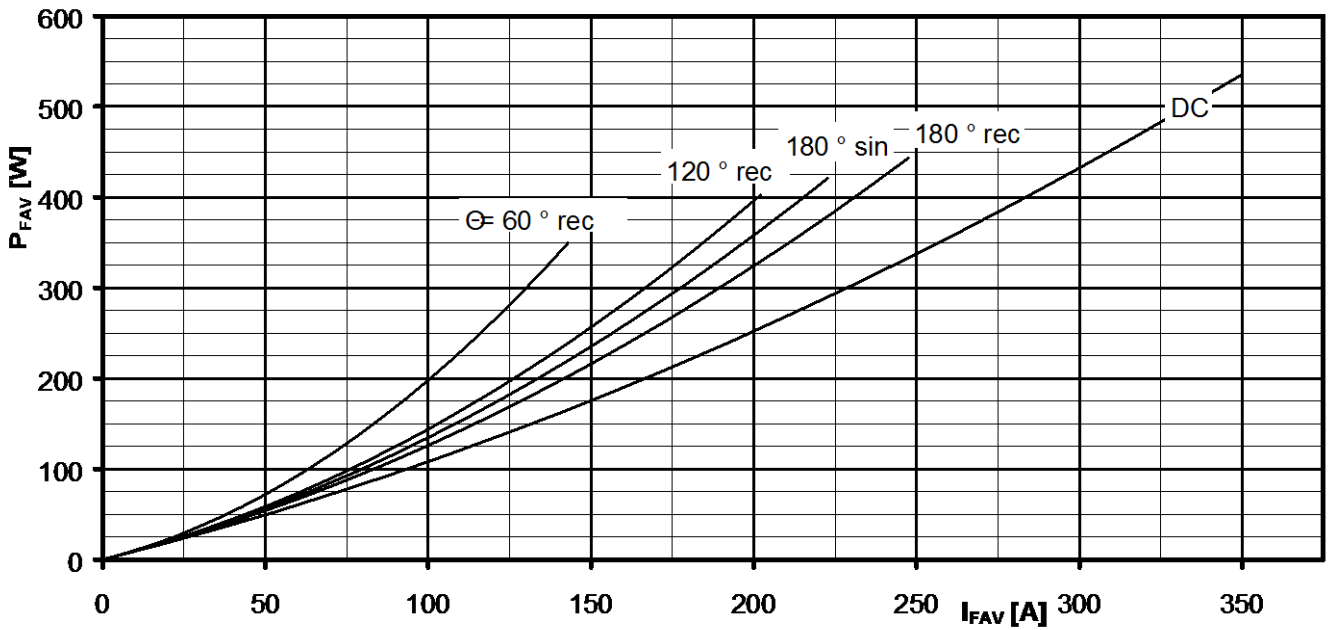

On-state power loss per arm $P_{FAV} = f(I_{FAV})$

Parameter: Current conduction angle Θ

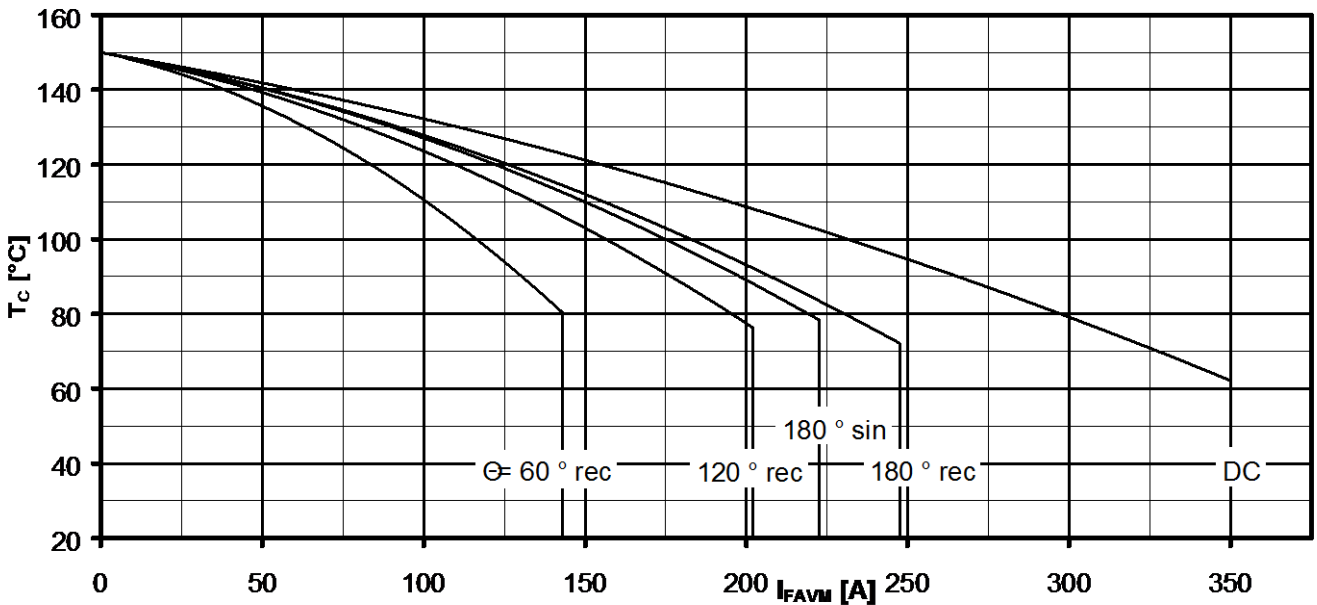

Maximum allowable case temperature $T_C = f(I_{FAVM})$

Current load per arm

Calculation base P_{TAV} (switching losses should be considered separately)

Parameter: Current conduction angle Θ

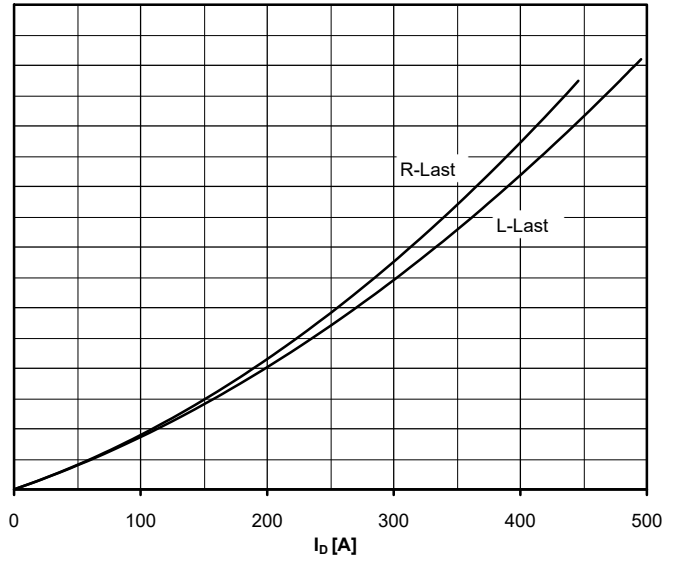
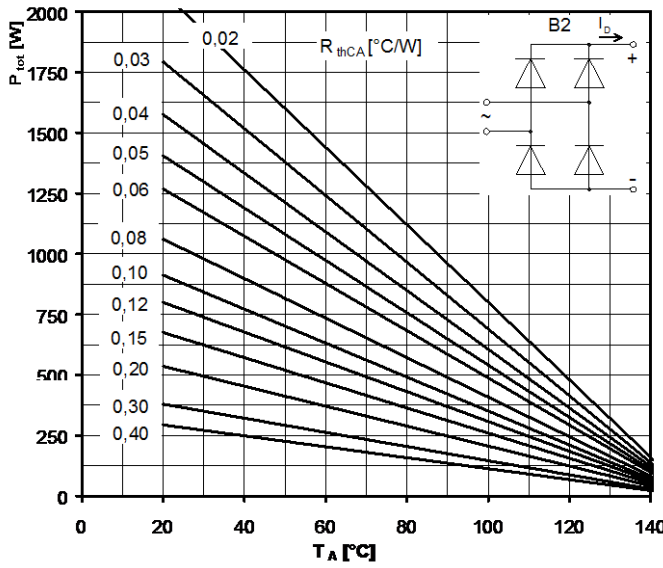

Maximum rated output current I_b

B2- Two-pulse bridge circuit

Total power dissipation at circuit P_{tot}

Parameter:

Thermal resistance cases to ambient R_{thCA}

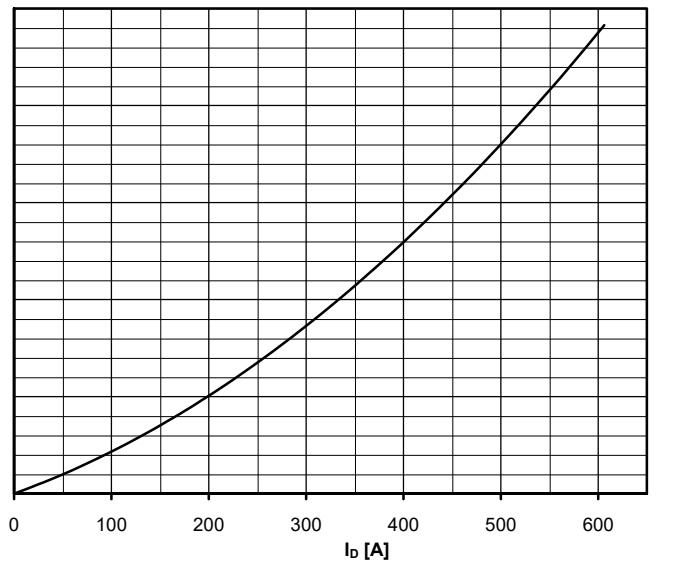
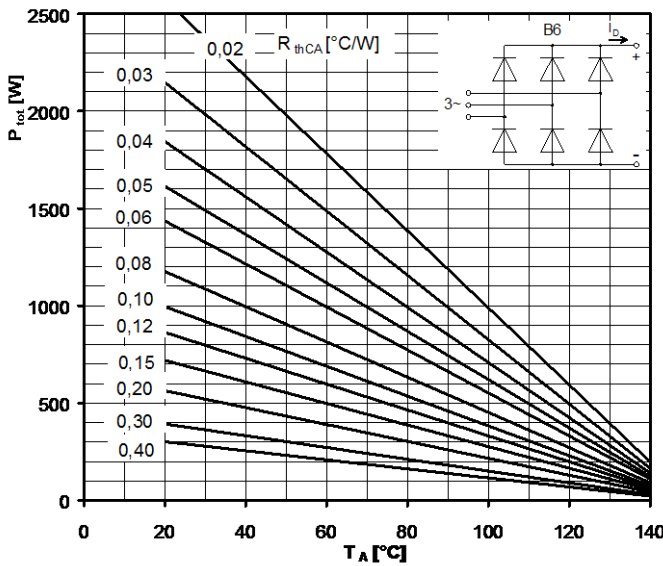

Maximum rated output current I_b

B6- Six-pulse bridge circuit

Total power dissipation at circuit P_{tot}

Parameter:

Thermal resistance cases to ambient R_{thCA}

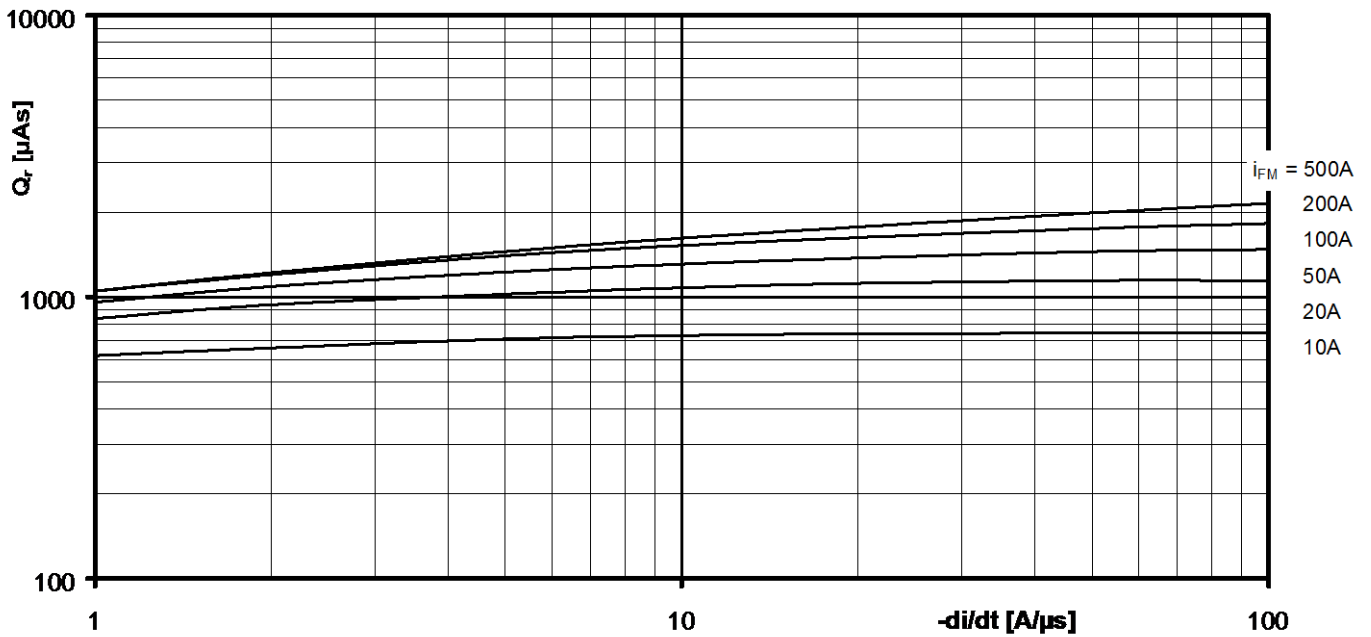

Recovered charge $Q_r = f(-di/dt)$

$T_{vj} = T_{vjmax}$, $v_R \leq 0,5 V_{RRM}$, $v_{RM} = 0,8 V_{RRM}$

Parameter: On-state current i_{FM}

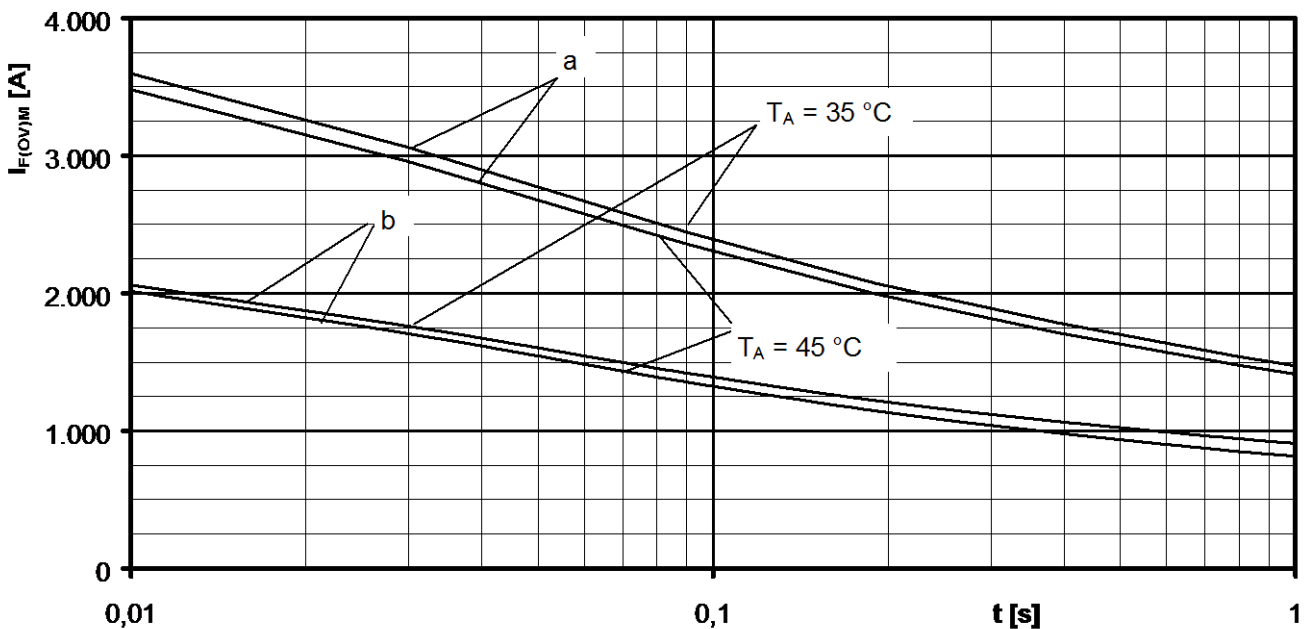

Maximum overload on-state current per arm $I_{F(OV)M} = f(t)$, $v_{RM} = 0,8 V_{RRM}$

a: No-load conditions

b: Pre-load current per arm $I_{FAV(vor)} = I_{FAVM}$

$T_a = 35^\circ\text{C}$, Forced air cooling Heatsink type: KM17 (Papst 4650)

$T_a = 45^\circ\text{C}$, Natural air cooling Heatsink type: KM17 (60W)

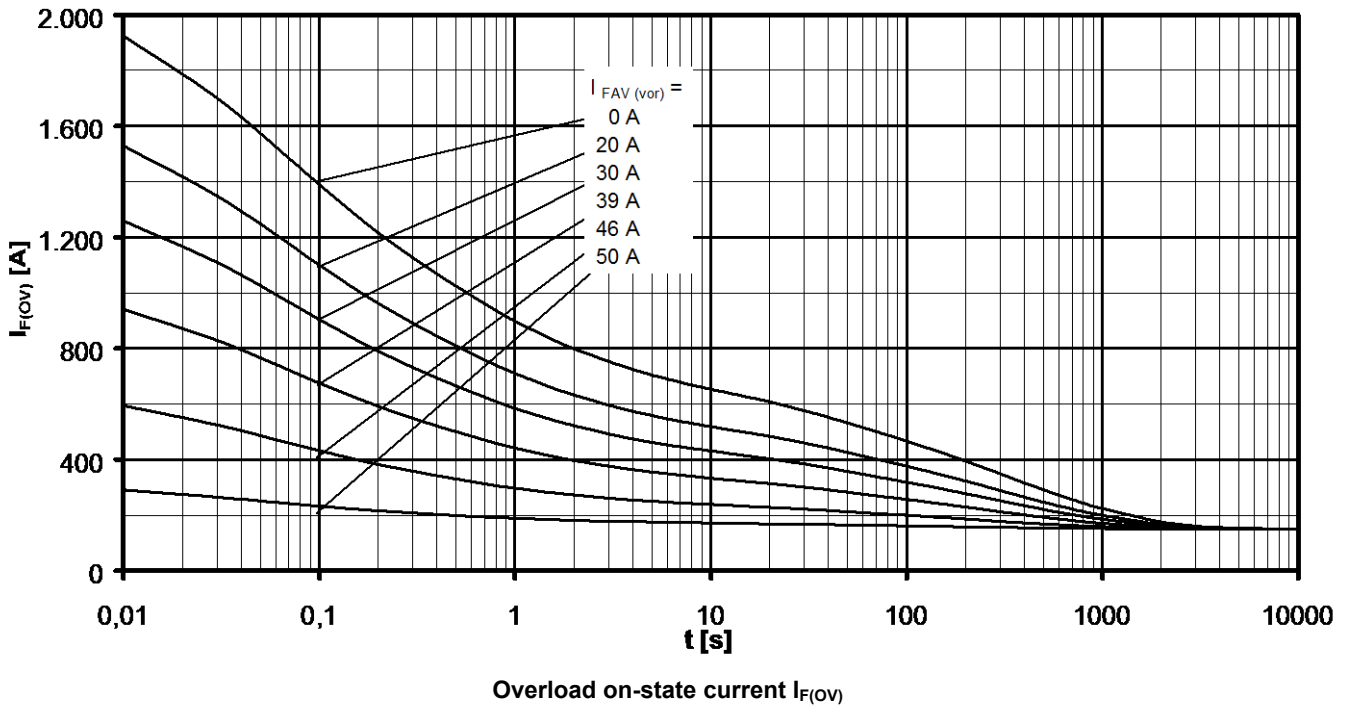

B6- Six-pulse bridge circuit, 120° rectangular Heatsink type KM17 (60W)

Natural cooling at $T_A = 45^\circ\text{C}$ Parameter: Pre-load current per arm $I_{FAV(vor)}$