



## Key Parameters

$I_{F(AV)M}$	=	171	A
$V_{RRM}$	=	1200	V
$I_{FSM}$	=	6600	A
$V_{T0}$	=	0.75	V
$r_T$	=	0.8	mΩ

## Properties

- International standard package
- High operation reliability
- Electrically insulated base plate

## MAXIMUM ALLOWABLE RATINGS

Symbols and parameters			Maximum Limits	Unit
$V_{RRM}$	Repetitive peak reverse voltage	$T_{vj} = -40^{\circ}\text{C} \dots T_{vj \text{ max}}$	1200	V
$V_{RSM}$	Non-repetitive peak reverse voltage	$T_{vj} = +25^{\circ}\text{C} \dots T_{vj \text{ max}}$	1300	V
$I_{FAVM}$	Average on-state current	$T_C = 100^{\circ}\text{C}$	171	A
$I_{FRMSM}$	Maximum RMS on-state current		270	A
$I_{FSM}$	Surge current	$T_{vj} = 25^{\circ}\text{C}, t_p = 10 \text{ ms}$	6600	A
		$T_{vj} = T_{vj \text{ max}}, t_p = 10 \text{ ms}$	5600	A
$I^2t$	Safety factor	$T_{vj} = 25^{\circ}\text{C}, t_p = 10 \text{ ms}$	218000	A <sup>2</sup> s
		$T_{vj} = T_{vj \text{ max}}, t_p = 10 \text{ ms}$	157000	A <sup>2</sup> s

## CHARACTERISTICS

Symbols and parameters			Value			Unit
			min	typ	max	
$V_F$	On-state voltage	$T_{vj} = T_{vj\ max}, I_F = 500\ A$			1.26	V
$V_{(TO)}$	Threshold voltage	$T_{vj} = T_{vj\ max}$			0.75	V
$r_T$	Slope resistance	$T_{vj} = T_{vj\ max}$			0.8	mΩ
$I_R$	Reverse current	$T_{vj} = T_{vj\ max}, V_R = V_{RRM}$			20	mA
$V_{ISOL}$	Insulation test voltage	RMS, f = 50Hz, t = 1 sec RMS, f = 50Hz, t = 1 min			3.0 2.5	kV

## THERMAL PARAMETERS

Symbols and parameters			Value	Unit
$R_{th(j-c)}$	Thermal resistance, junction to case	per Module, $\theta = 180^\circ\ sin$ per arm, $\theta = 180^\circ\ sin$ per Module, DC per arm, DC	0.130 0.260 0.126 0.252	°C/W
$R_{th(c-h)}$	Thermal resistance, case to heatsink	per Module per arm	0.03 0.06	°C/W
$T_{vj\ max}$	Maximum junction temperature		+150	°C
$T_{C\ op}$	Operating temperature range		-40...+150	°C
$T_{stg}$	Storage temperature range		-40...+150	°C

## MECHANICAL PARAMETERS

Symbols and parameters			Value	Unit
<b>M1</b>	Mounting torque	Tolerance $\pm 15\%$	6	Nm
<b>M2</b>	Terminal connection torque	Tolerance $\pm 10\%$	6	Nm
<b>W</b>	Weight		310	g
<b>a</b>	Vibration resistance	f = 50 Hz	50	m/s <sup>2</sup>

## DIMENSIONS

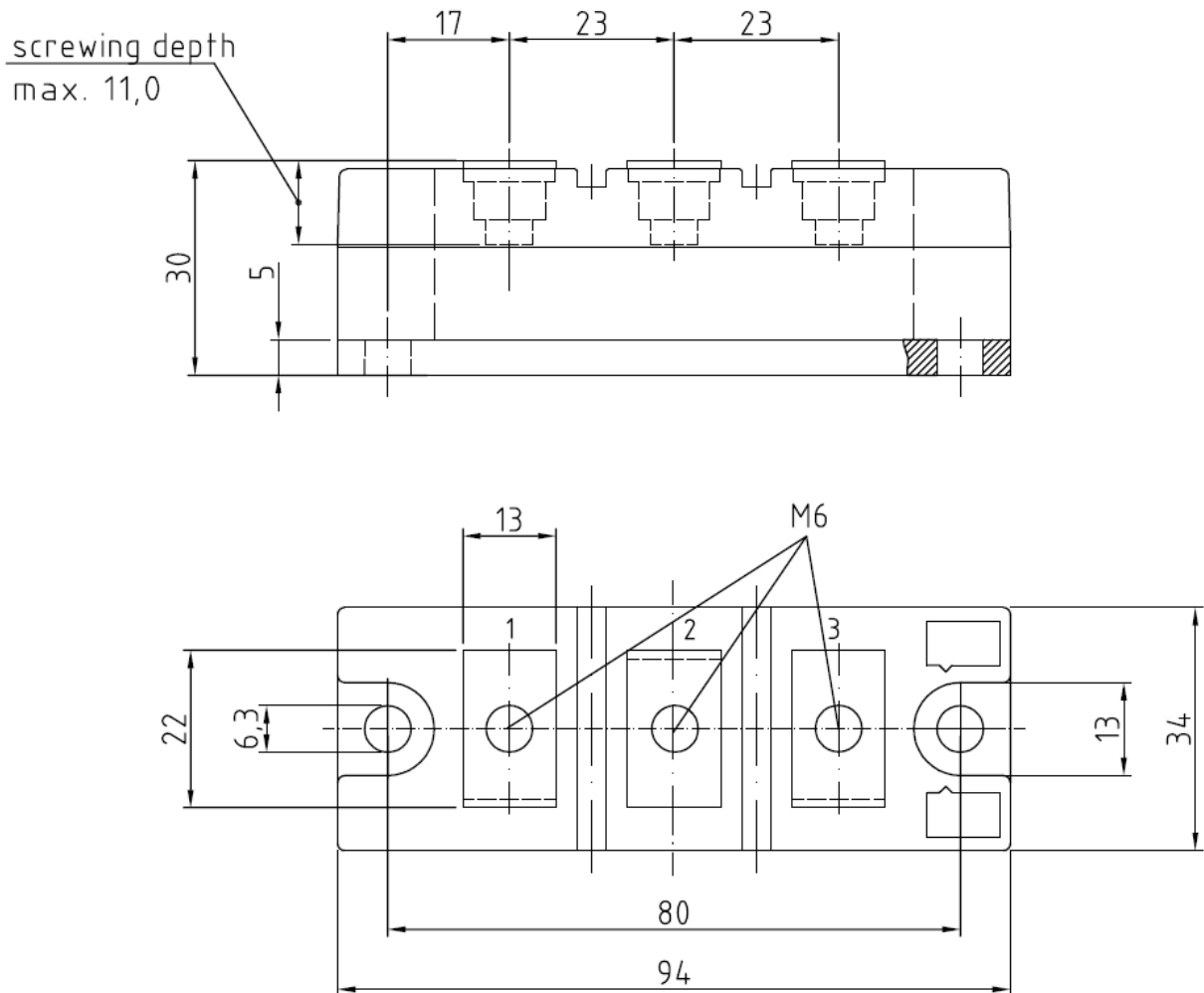

## TOPOLOGY OF INTERNAL CONNECTION

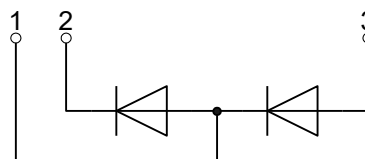

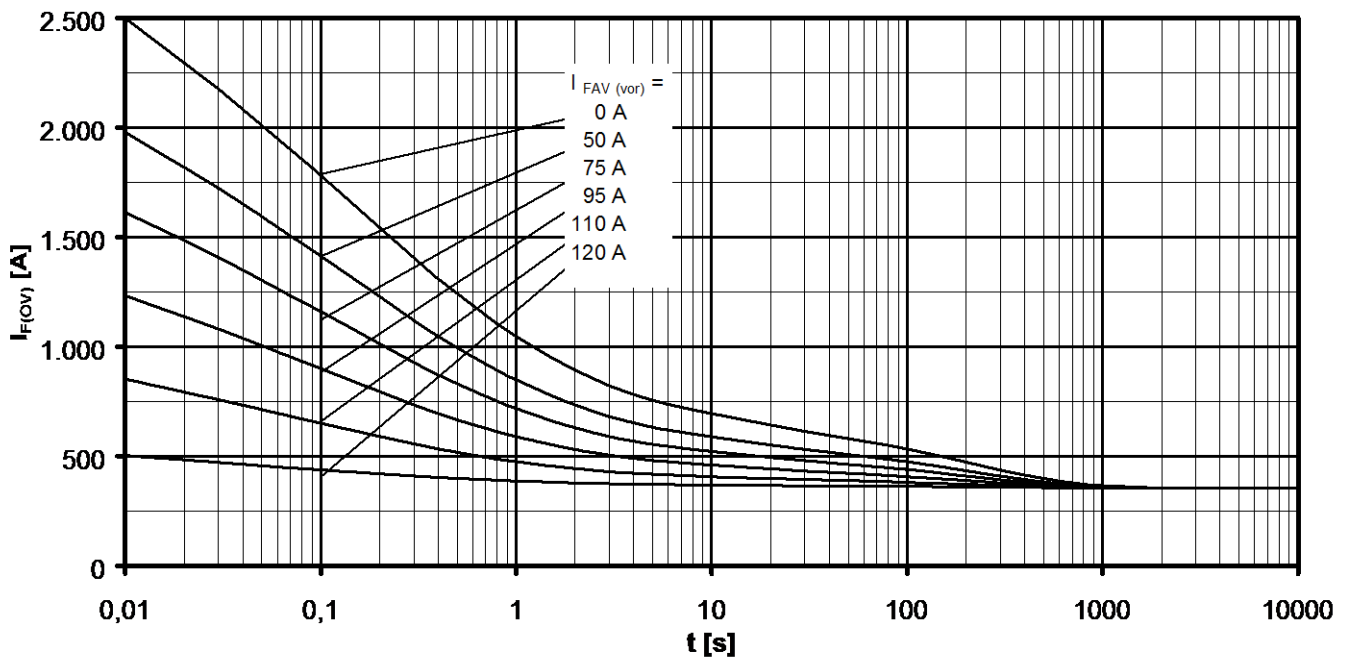

Overload on-state current  $I_{F(ov)}$

B6- Six-pulse bridge circuit 120° rectangular

Heatsink type KM17 (Papst 4650) Forced cooling at  $T_A = 35^\circ\text{C}$

Parameter: Pre-load current per arm  $I_{FAV(vor)}$

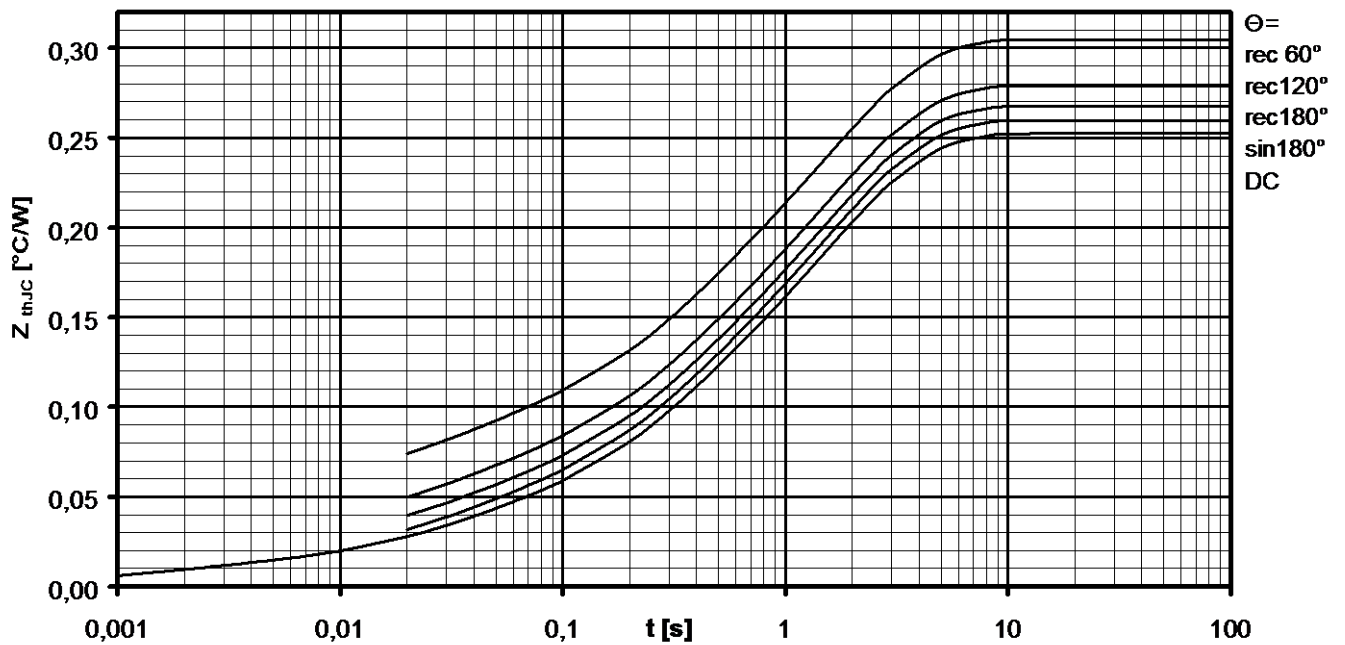

Transient thermal impedance per arm  $Z_{thJC} = f(t)$

Parameter: Current conduction angle  $\Theta$

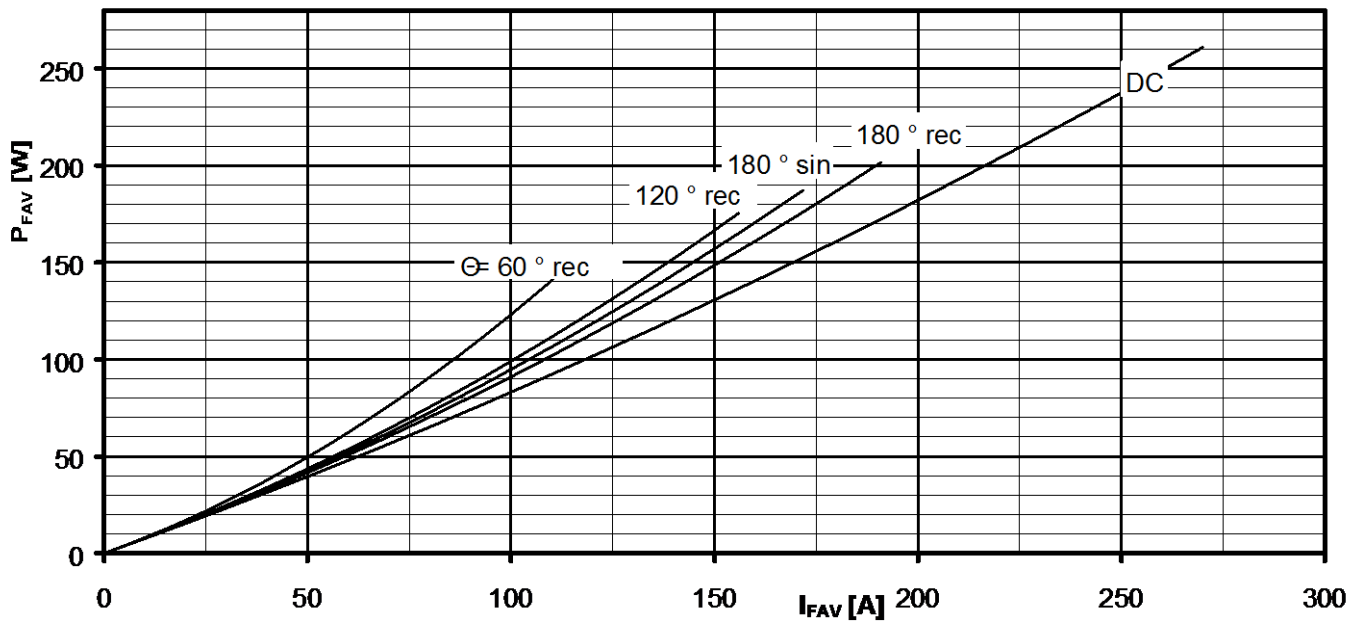

On-state power loss per arm  $P_{FAV} = f(I_{FAV})$

Parameter: Current conduction angle  $\Theta$

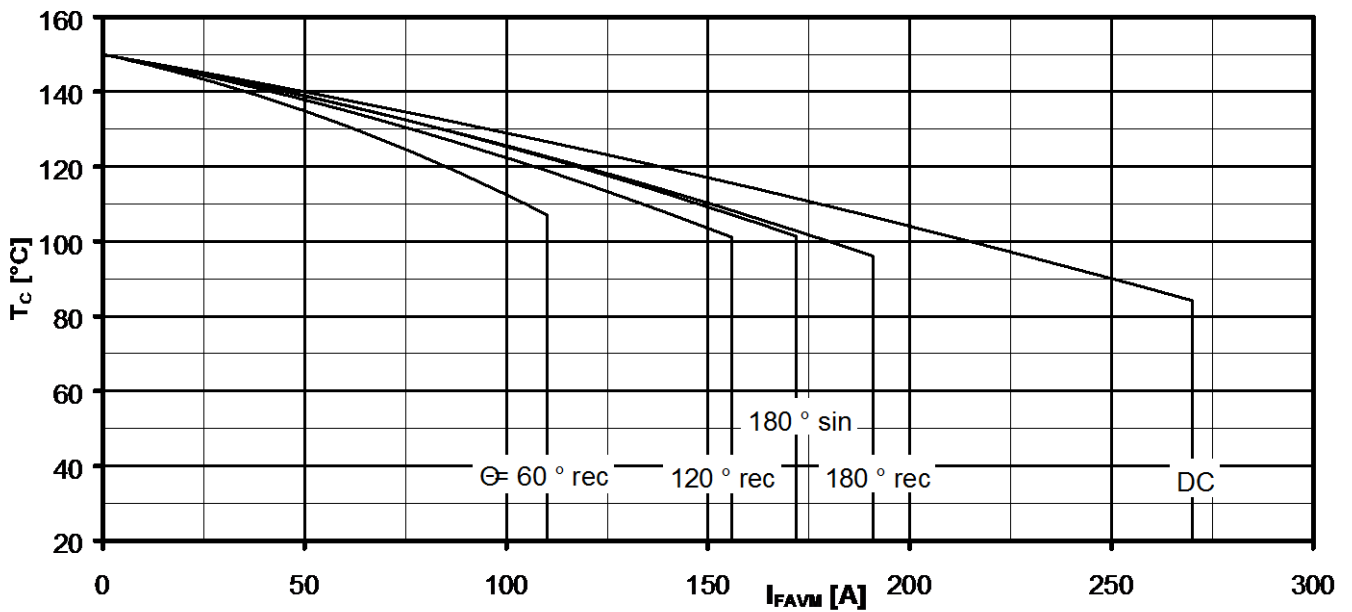

Maximum allowable case temperature  $T_C = f(I_{FAVM})$

Current load per arm

Calculation base  $P_{TAV}$

Parameter: Current conduction angle  $\Theta$

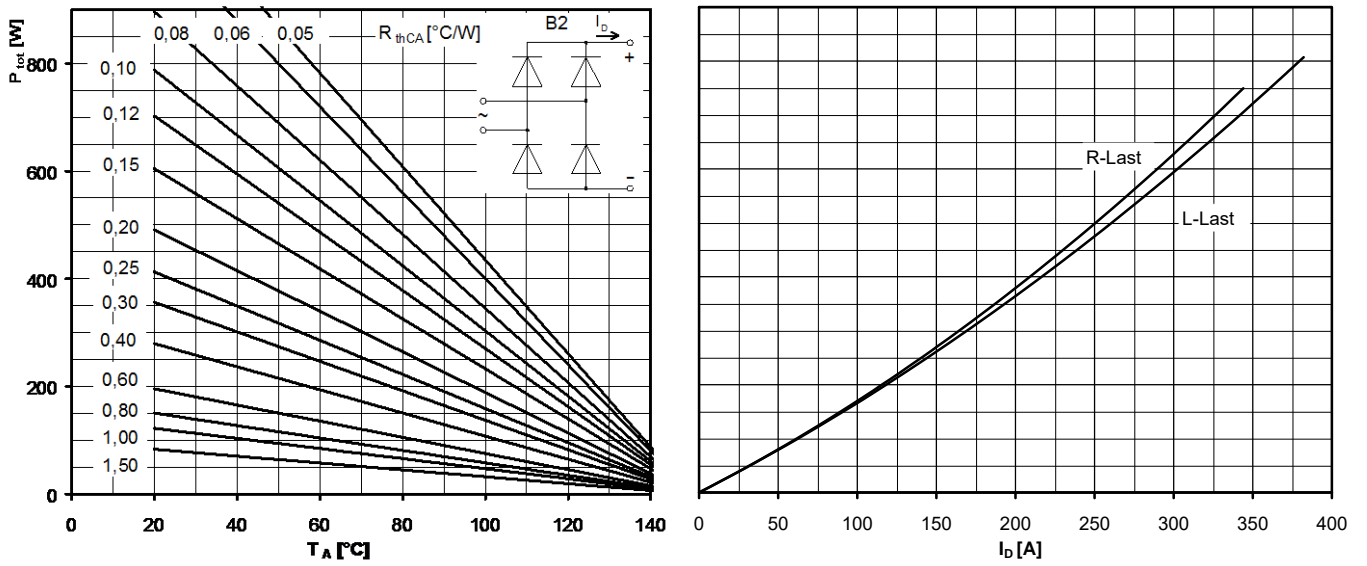

Maximum rated output current  $I_b$

B2- Two-pulse bridge circuit

Total power dissipation at circuit  $P_{tot}$

Parameter:

Thermal resistance cases to ambient  $R_{thCA}$

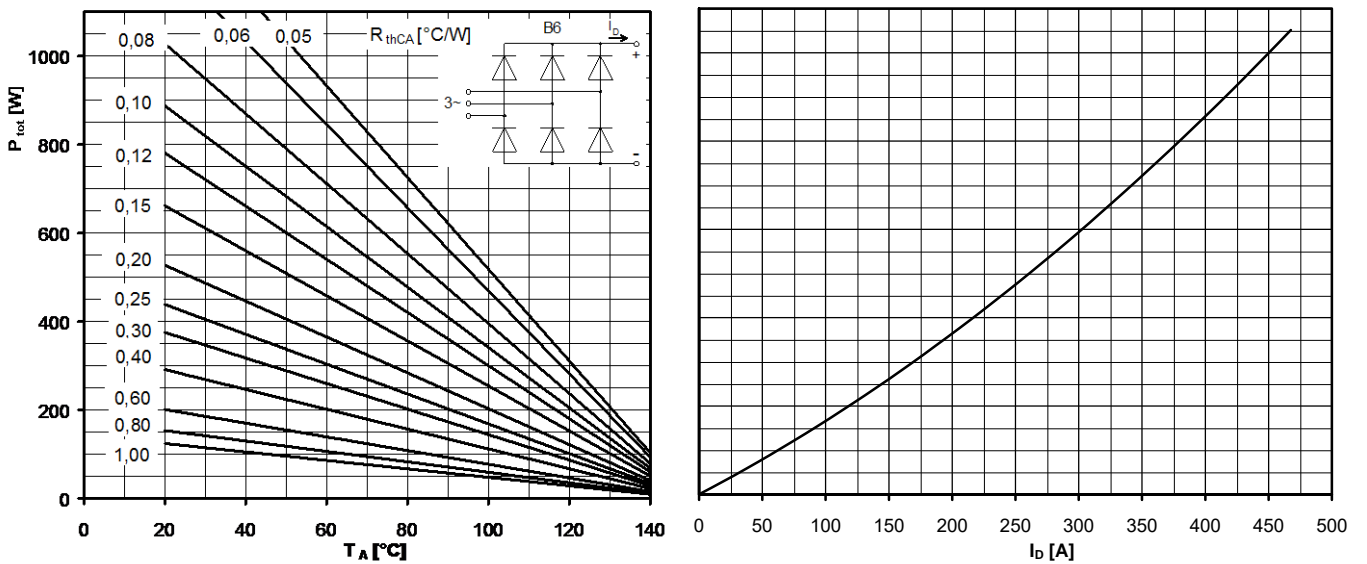

Maximum rated output current  $I_b$

B6- Six-pulse bridge circuit

Total power dissipation at circuit  $P_{tot}$

Parameter:

Thermal resistance cases to ambient  $R_{thCA}$

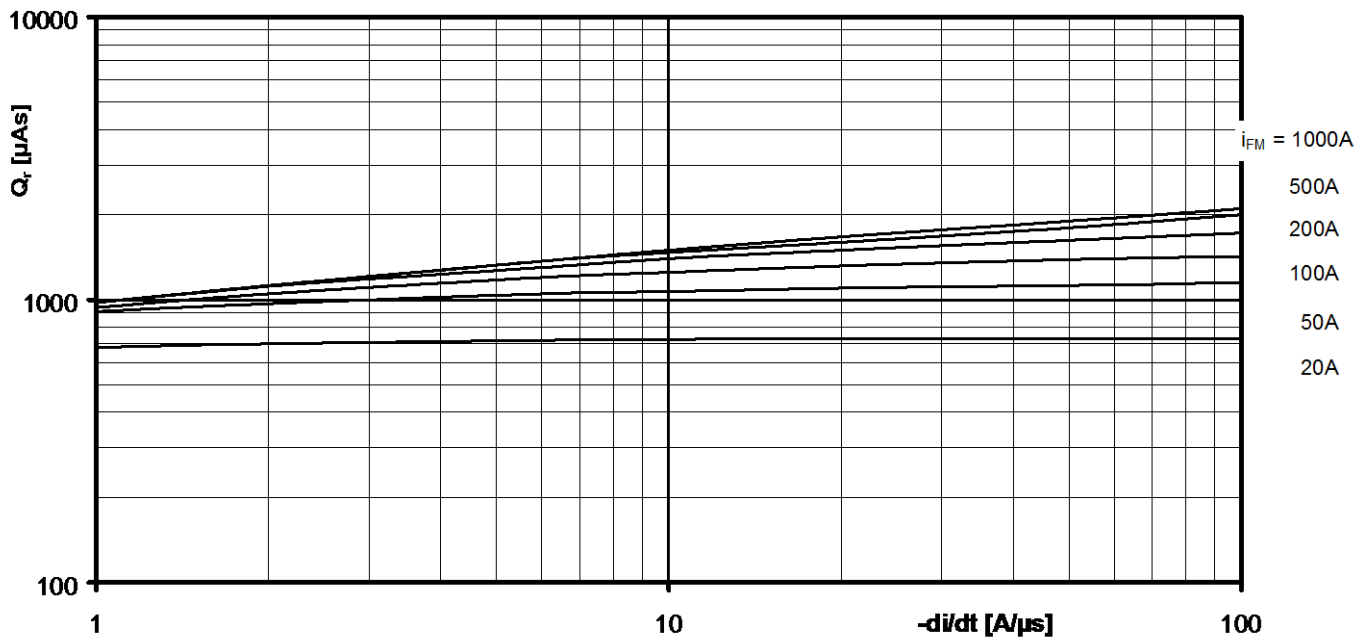

Recovered charge  $Q_r = f(-di/dt)$

$T_{vj} = T_{vjmax}$ ,  $v_R \leq 0,5 V_{RRM}$ ,  $v_{RM} = 0,8 V_{RRM}$

Parameter: On-state current  $i_{FM}$

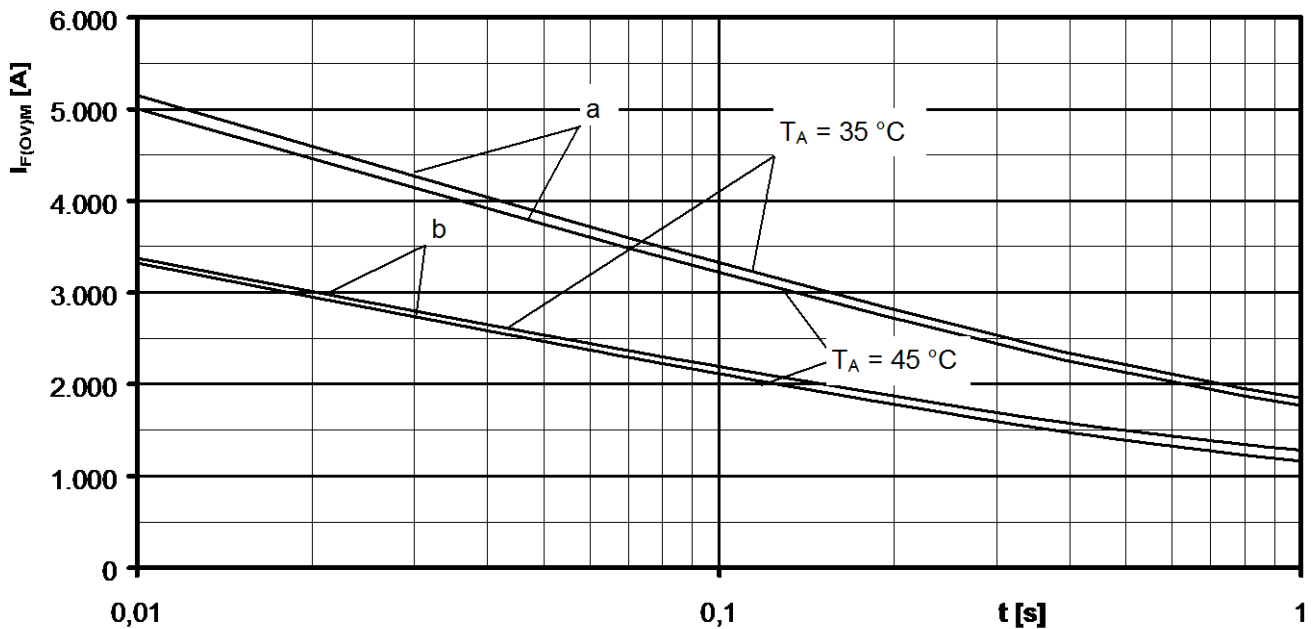

Maximum overload on-state current per arm  $I_{F(OV)M} = f(t)$ ,  $v_{RM} = 0,8 V_{RRM}$

a: No-load conditions

b: Pre-load current per arm  $I_{F(AV(vor))} = I_{F(AVM)}$

$T_a = 35^\circ\text{C}$ , Forced air cooling Heatsink type: KM17 (Papst 4650)

$T_a = 45^\circ\text{C}$ , Natural air cooling Heatsink type: KM17 (60W)

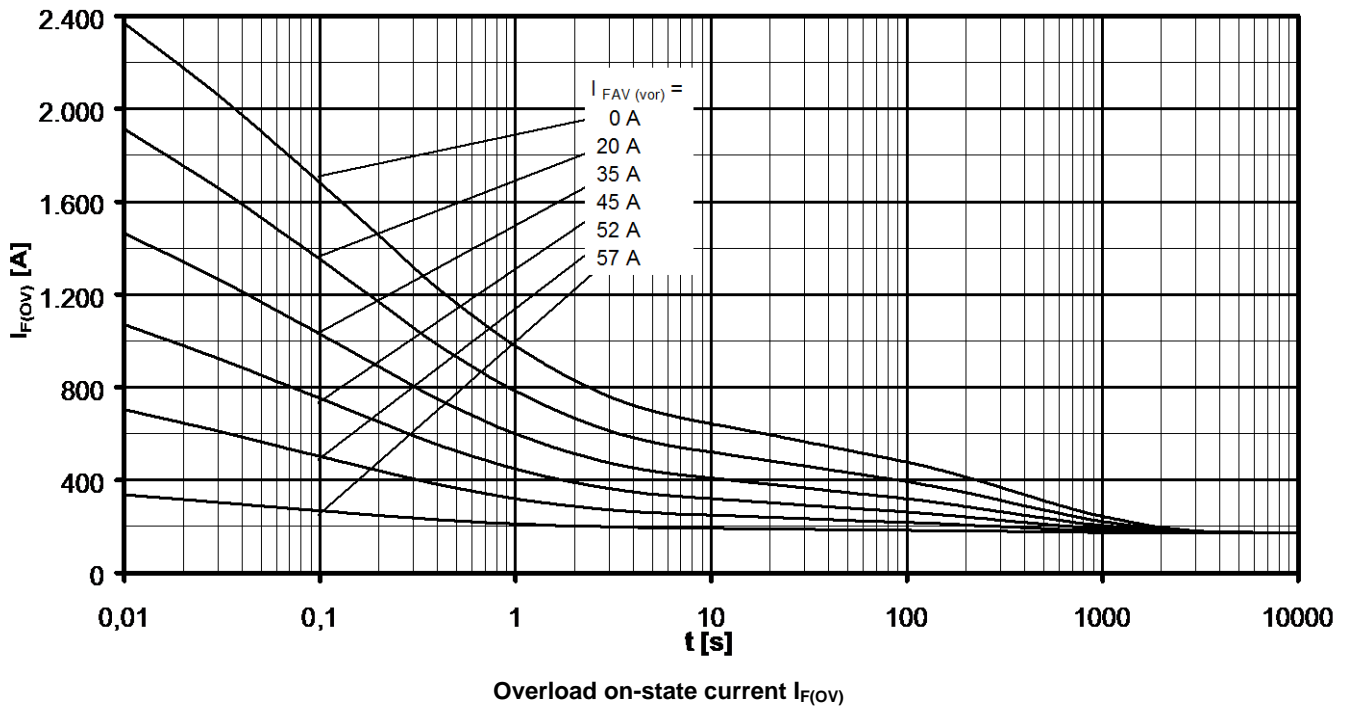

B6- Six-pulse bridge circuit, 120° rectangular Heatsink type KM17 (60W)

Natural cooling at  $T_A = 45^\circ\text{C}$

Parameter: Pre-load current per arm  $I_{FAV(vor)}$