



Key Parameters

$I_{F(AV)M}$	=	130	A
V_{RRM}	=	1600	V
I_{FSM}	=	2500	A
V_{T0}	=	0.87	V
r_T	=	2.54	mΩ

Properties

- International standard package
- High operation reliability
- Electrically insulated base plate

MAXIMUM ALLOWABLE RATINGS

Symbols and parameters			Maximum Limits	Unit
V_{RRM}	Repetitive peak reverse voltage	$T_{vj} = -40^{\circ}\text{C} \dots T_{vj \text{ max}}$	1600	V
V_{RSM}	Non-repetitive peak reverse voltage	$T_{vj} = +25^{\circ}\text{C} \dots T_{vj \text{ max}}$	1700	V
I_{FAVM}	Average on-state current	$T_C = 100^{\circ}\text{C}$	134	A
I_{FRMSM}	Maximum RMS on-state current		210	A
I_{FSM}	Surge current	$T_{vj} = 25^{\circ}\text{C}, t_p = 10 \text{ ms}$	2500	A
		$T_{vj} = T_{vj \text{ max}}, t_p = 10 \text{ ms}$	2000	A
I^2t	Safety factor	$T_{vj} = 25^{\circ}\text{C}, t_p = 10 \text{ ms}$	31250	A ² s
		$T_{vj} = T_{vj \text{ max}}, t_p = 10 \text{ ms}$	20000	A ² s

CHARACTERISTICS

Symbols and parameters			Value			Unit
			min	typ	max	
V_F	On-state voltage	$T_{vj} = 25^\circ\text{C}, I_F = 300\text{ A}$			1.6	V
$V_{(TO)}$	Threshold voltage	$T_{vj} = T_{vj\text{ max}}$			0.87	V
r_T	Slope resistance	$T_{vj} = T_{vj\text{ max}}$			2.45	mΩ
I_R	Reverse current	$T_{vj} = T_{vj\text{ max}}, V_R = V_{RRM}$			3	mA
V_{ISOL}	Insulation test voltage	RMS, $f = 50\text{ Hz}, t = 1\text{ sec}$ RMS, $f = 50\text{ Hz}, t = 1\text{ min}$			3.6 3.0	kV

THERMAL PARAMETERS

Symbols and parameters			Value	Unit
$R_{th(j-c)}$	Thermal resistance, junction to case	per Module, $\theta = 180^\circ\text{ sin}$	0.100	K/W
		per arm, $\theta = 180^\circ\text{ sin}$	0.200	
		per Module, DC	0.095	
		per arm, DC	0.190	
$R_{th(c-h)}$	Thermal resistance, case to heatsink	per Module	0.11	K/W
		per arm	0.22	
$T_{vj\text{ max}}$	Maximum junction temperature		+130	°C
$T_{C\text{ op}}$	Operating temperature range		-40...+125	°C
T_{stg}	Storage temperature range		-40...+125	°C

MECHANICAL PARAMETERS

Symbols and parameters			Value	Unit
M1	Mounting torque	Tolerance $\pm 15\%$	5	Nm
M2	Terminal connection torque	Tolerance $\pm 15\%$	3	Nm
W	Weight		75	g
a	Vibration resistance	$f = 50\text{ Hz}$	50	m/s ²

DIMENSIONS

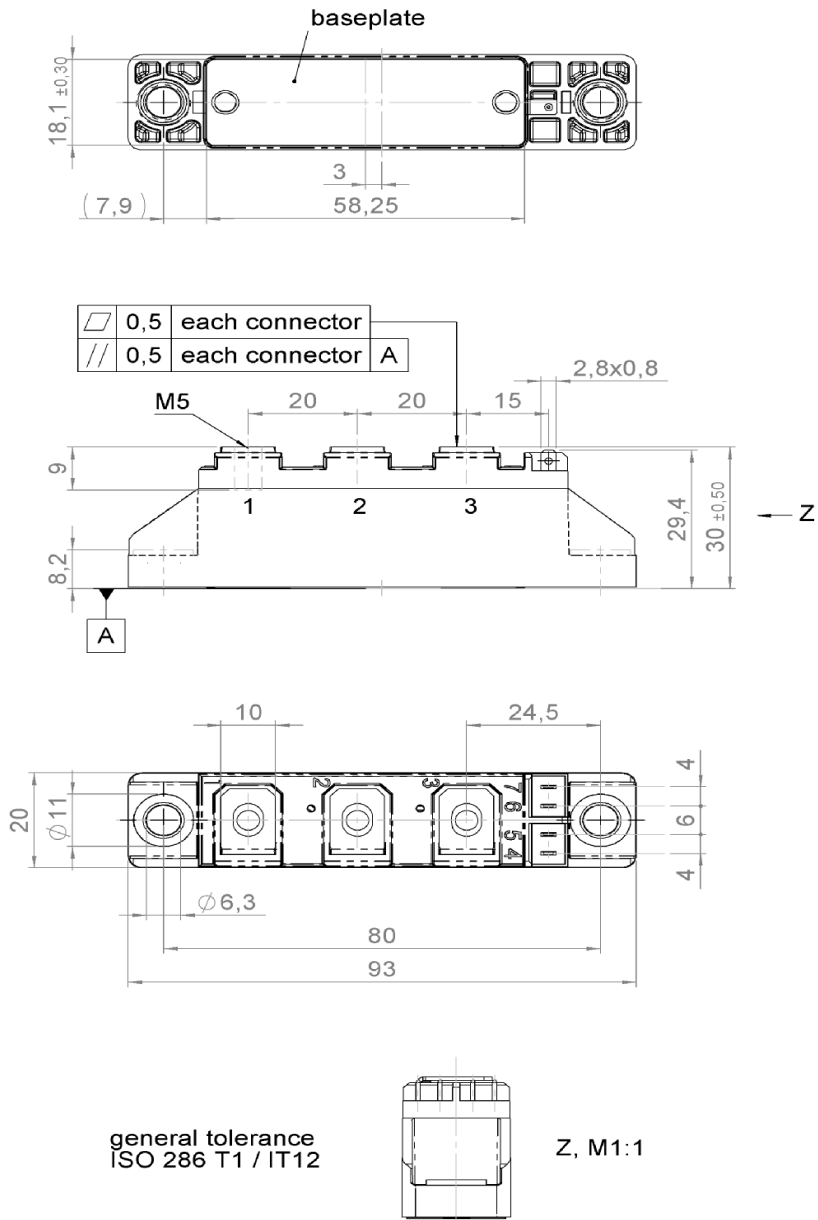

TOPOLOGY OF INTERNAL CONNECTION

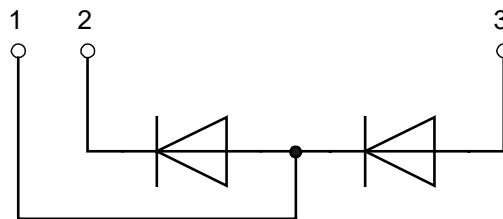

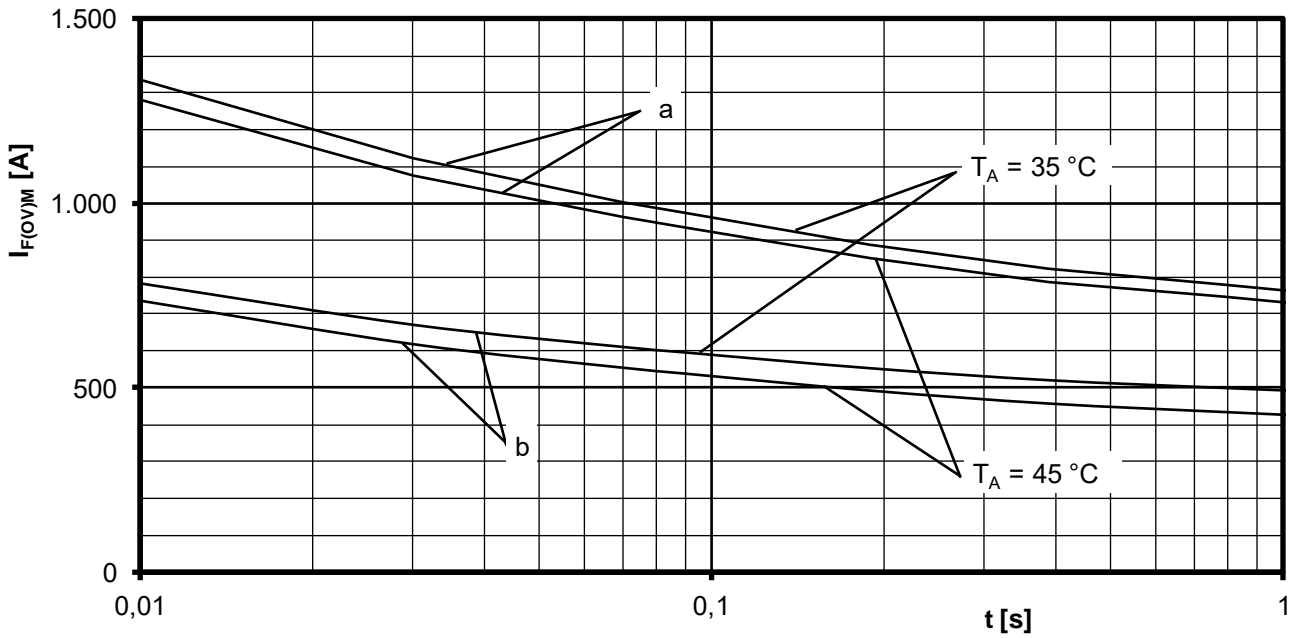

Maximum overload on-state current per arm $I_{F(OV)M} = f(t)$, $v_{RM} = 0,8 V_{RRM}$

a: No-load conditions

b: Pre-load current per arm $I_{FAV(vor)} = I_{FAVM}$

$T_a = 35\text{ °C}$, Forced air cooling Heatsink type: KM14 (Papst 4650)

$T_a = 45\text{ °C}$, Natural air cooling Heatsink type: KM17 (160W)

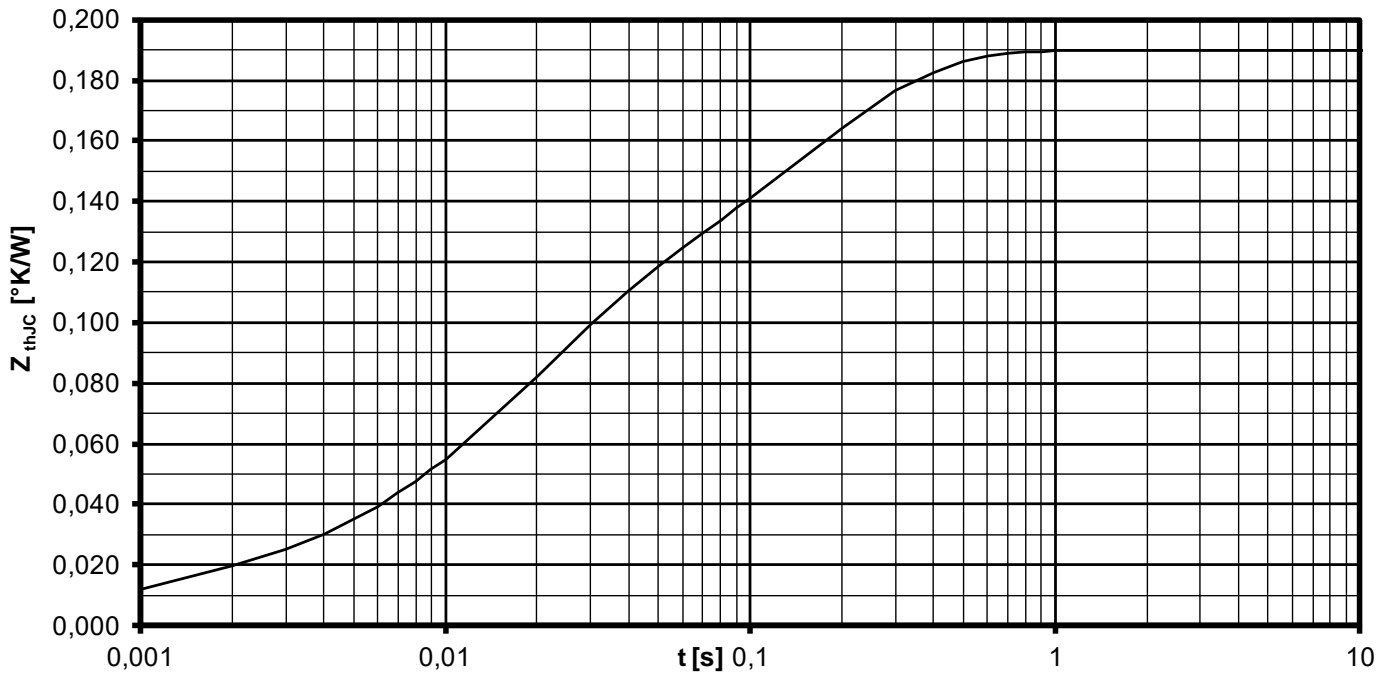

Transient thermal impedance per arm $Z_{thJC} = f(t)$

Parameter: Current conduction angle Θ

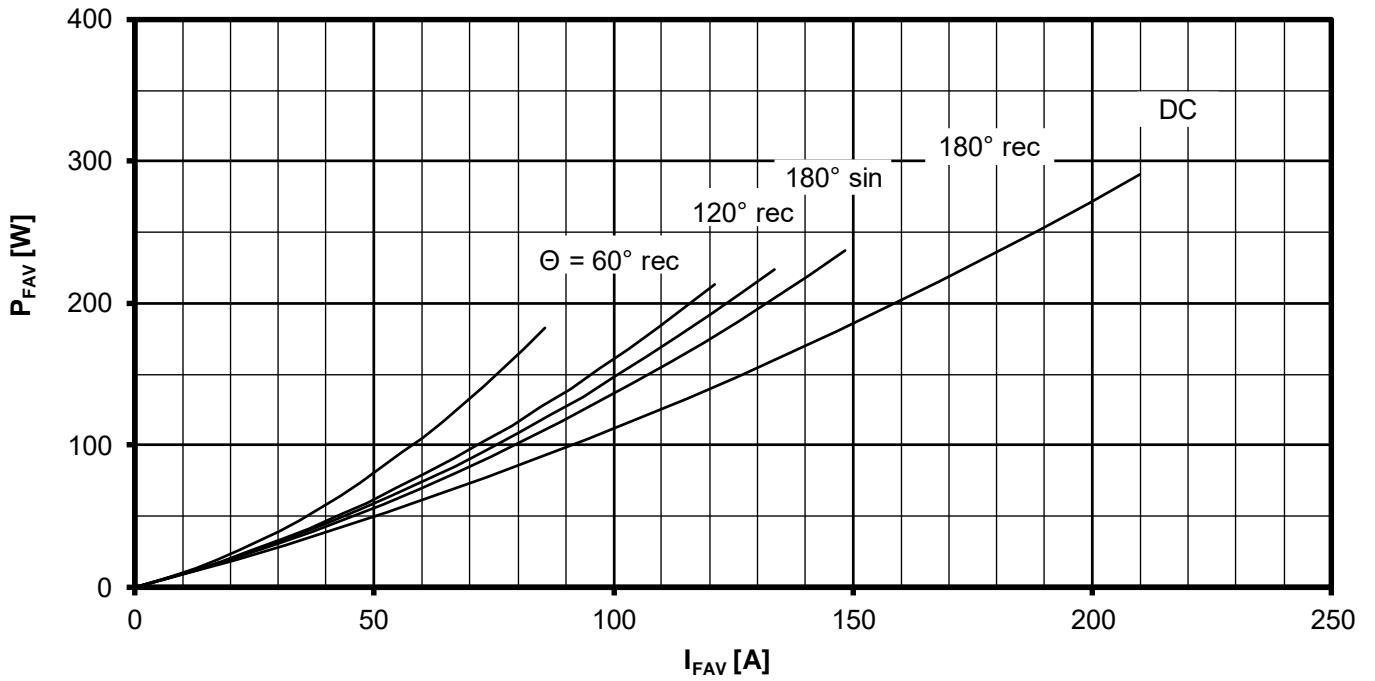

On-state power loss per arm $P_{FAV} = f(I_{FAV})$

Parameter: Current conduction angle Θ

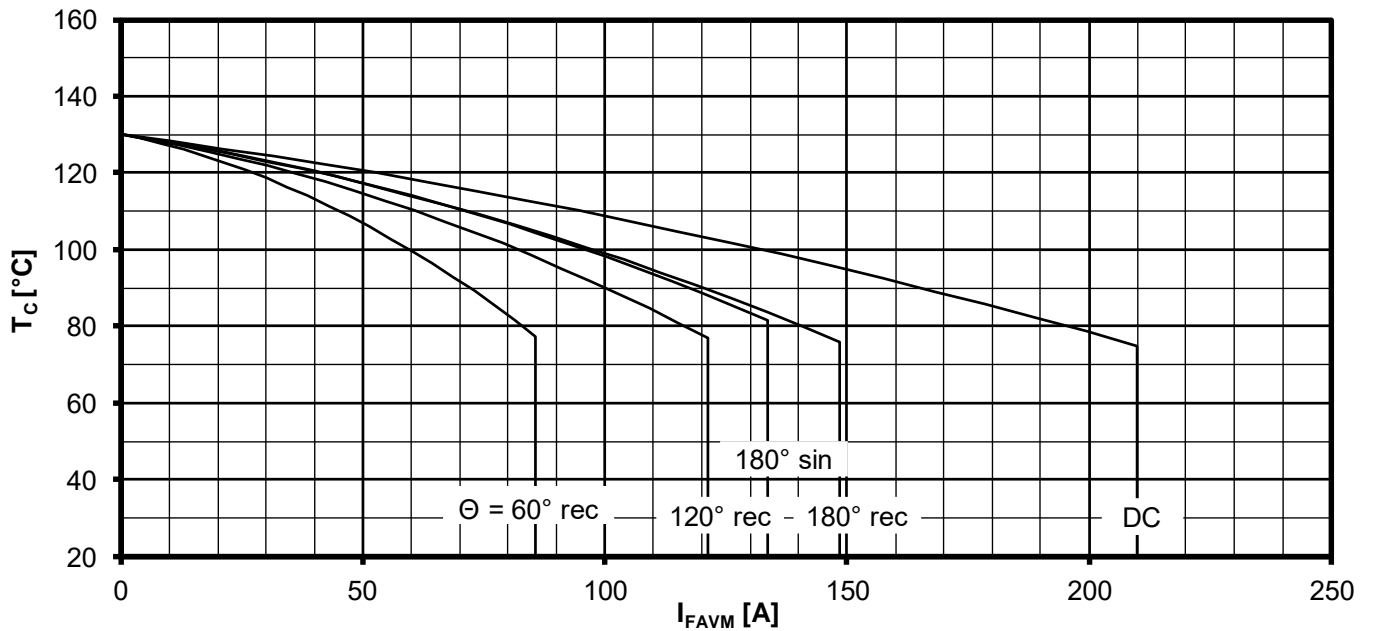

Maximum allowable case temperature $T_C = f(I_{FAVM})$

Current load per arm

Calculation base P_{TAV}

Parameter: Current conduction angle Θ

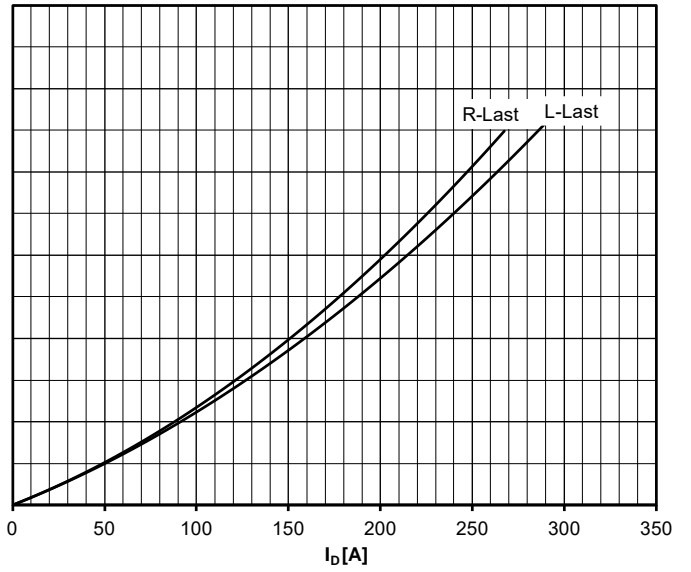
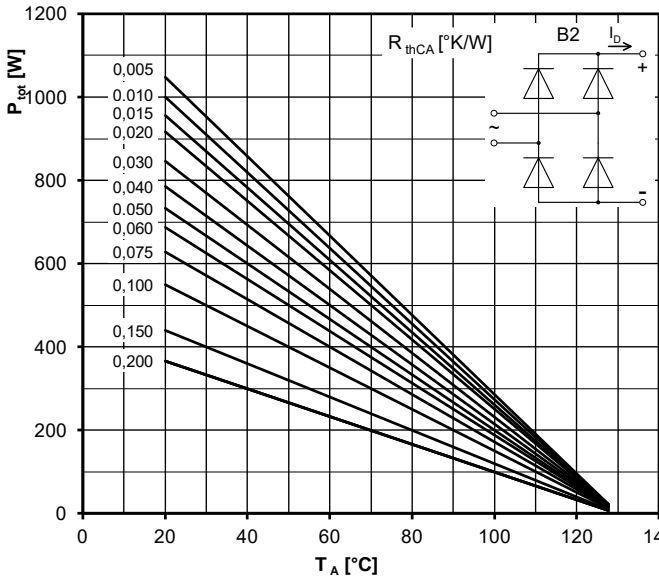

Maximum rated output current I_b

B2- Two-pulse bridge circuit

Total power dissipation at circuit P_{tot}

Parameter:

Thermal resistance cases to ambient R_{thCA}

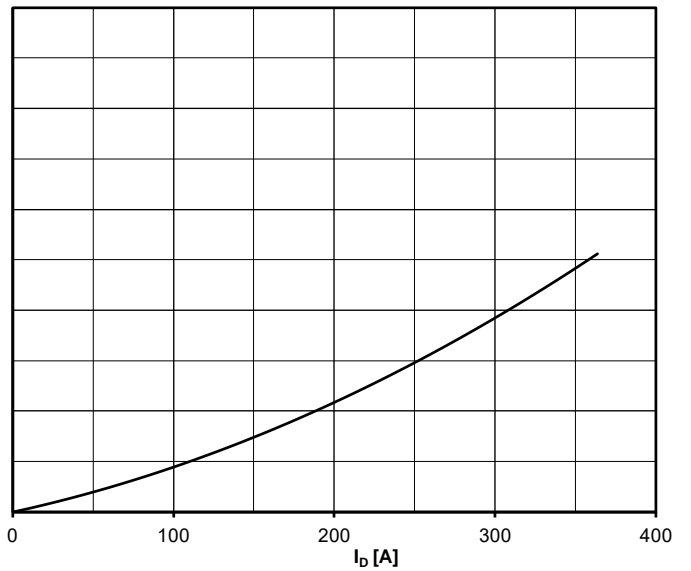
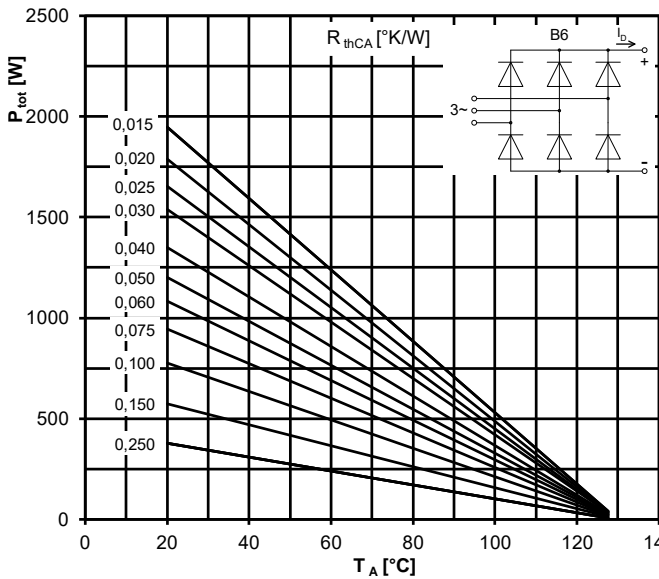

Maximum rated output current I_b

B6- Six-pulse bridge circuit

Total power dissipation at circuit P_{tot}

Parameter:

Thermal resistance cases to ambient R_{thCA}