

Key Parameters

V_{DRM}	=	1600 V
I_{TAVM}	=	570 A
t_q	=	20 μ s
I_{TSM}	=	8000 A
V_{TO}	=	1.10 V
r_T	=	0.750 m Ω

Fast Switching Thyristor

5STF 06D1620

Doc. No. 5SYA 1033-01 Apr.96

Features

- Patented free-floating silicon technology
- Designed for traction and industrial applications
- Optimum switching performance

Blocking

Part number	5STF 06D1620	5STF 06D1420	5STF 06D1220	Conditions
V_{DRM} V_{RRM}	1600 V	1400 V	1200 V	$f = 50\text{Hz}$, $t_p = 10\text{ms}$
V_{RSM1}	1700 V	1500 V	1300 V	$t_p = 5\text{ms}$, single pulse
I_{DRM}	$\leq 100 \text{ mA}$			V_{DRM}
I_{RRM}	$\leq 100 \text{ mA}$			V_{RRM}
dv/dt_{crit}	500 V/ μ s			@ Exp.to 0.67x V_{DR}
$T_{vj} = 125^\circ\text{C}$				

Mechanical data

F_m	Mounting force	nom	10 kN
		min	8 kN
		max	12 kN
a	Acceleration Device clamped		100 m/s ²
m	Weight		0.30 kg
D_s	Surface creepage distance		25 mm
D_a	Air strike distance		14 mm

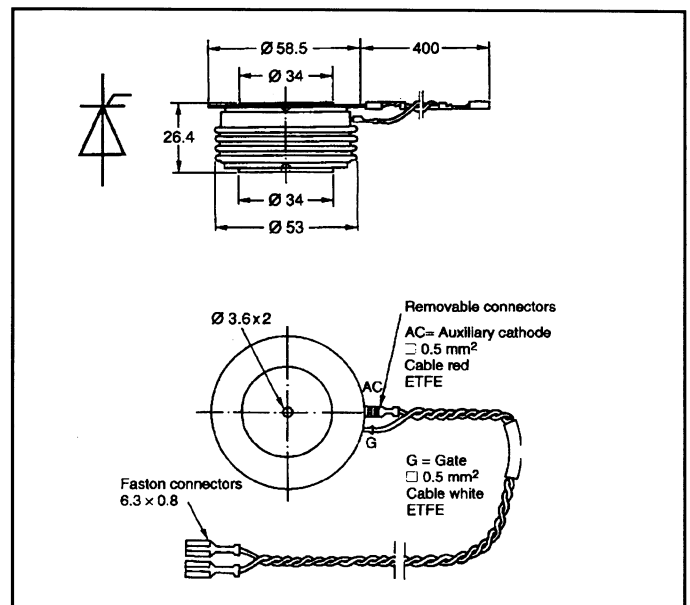

On-state

I_{TAVM}	Max. average on-state current	570 A	Half sine wave, $T_c = 70^\circ\text{C}$	
I_{TRMS}	Max. RMS on-state current	890 A		
I_{TSM}	Max. peak non-repetitive surge current	8000 A	$t_p = 10\text{ ms}$	$T_{vj} = 125^\circ\text{C}$
		8700 A	$t_p = 8.3\text{ ms}$	
I^2t	Limiting load integral	320 kA ² s	$t_p = 10\text{ ms}$	
		310 kA ² s	$t_p = 8.3\text{ ms}$	
V_T	On-state voltage	1.85 V	$I_T = 1000\text{ A}$	
V_{TO}	Threshold voltage	1.10 V		
r_T	Slope resistance	0.750 m Ω	$I_T = 330 - 1000\text{ A}$	
I_H	Holding current	30-60 mA	$T_{vj} = 25^\circ\text{C}$	
		15-50 mA	$T_{vj} = 125^\circ\text{C}$	
I_L	Latching current	150-500 mA	$T_{vj} = 25^\circ\text{C}$	
		50-300 mA	$T_{vj} = 125^\circ\text{C}$	

Switching

di/dt_{crit}	Critical rate of rise of on-state current	300 A/ μs	Cont.	$V_D \leq 0.67 \times V_{DRM}$ $T_{vj} = 125^\circ\text{C}$ $I_{TRM} = 1500\text{ A}$ $f = 50\text{ Hz}$ $I_{FG} = 2.0\text{ A}$ $t_r = 0.5\mu\text{s}$
		600 A/ μs	60 sec.	
t_d	Delay time	$\leq 2.0\ \mu\text{s}$	$V_D = 0.4 \times V_{DRM}$	$I_{FG} = 2.0\text{ A}$ $t_r = 0.5\mu\text{s}$
t_q	Turn-off time	$\leq 20\ \mu\text{s}$	$V_D \leq 0.67 \times V_{DRM}$ $dv_D/dt = 20\text{ V}/\mu\text{s}$	$I_{TRM} = 1500\text{ A}$ $T_{vj} = 125^\circ\text{C}$ $V_R > 100\text{ V}$
Q	Recovery charge	min	150 μAs	$di_T/dt = -20\text{ A}/\mu\text{s}$
		max	300 μAs	

Triggering

V_{GT}	Gate trigger voltage	2.6 V	$T_{vj} = 25^\circ\text{C}$
I_{GT}	Gate trigger current	400 mA	$T_{vj} = 25^\circ\text{C}$
V_{GD}	Gate non-trigger voltage	0.3 V	$V_D = 0.4 \times V_{DRM}$
I_{GD}	Gate non-trigger DC current	10 mA	$V_D = 0.4 \times V_{DRM}$
V_{FGM}	Peak forward gate voltage	12 V	
I_{FGM}	Peak forward gate current	10 A	
V_{RGM}	Peak reverse gate voltage	10 V	
P_G	Gate power losses	3 W	

Thermal

$T_{vj \text{ max}}$	Max. junction temperature	125 °C	
$T_{vj \text{ stg}}$	Storage temperature range	-40...150°C	
R_{thJC}	Thermal resistance junction to case	70 K/kW	Anode side cooled
		90 K/kW	Cathode side cooled
		40 K/kW	Double side cooled
R_{thCH}	Thermal resistance case to heat sink	30 K/kW	Single side cooled
		15 K/kW	Double side cooled

Analytical function for transient thermal impedance:

$$Z_{thJC} = \sum_{i=1}^n R_i(1-e^{-t/\tau_i})$$

i	1	2	3	4
R_i (K/W)	0.0146	0.0242	0.0011	
τ_i (s)	1.5606	0.1698	0.0028	

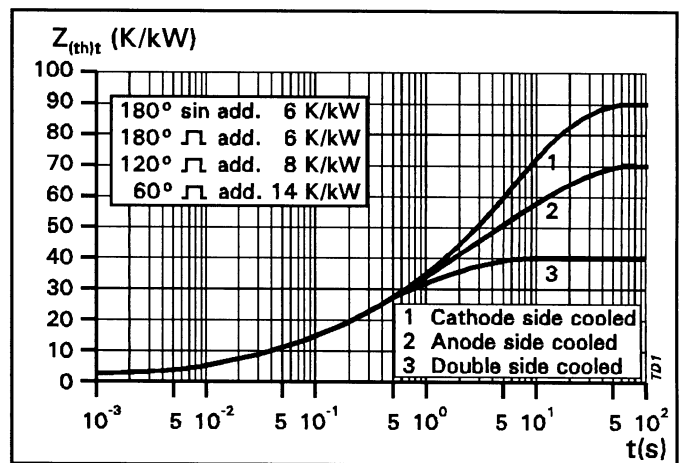

Fig.1 Transient thermal impedance, junction to case.

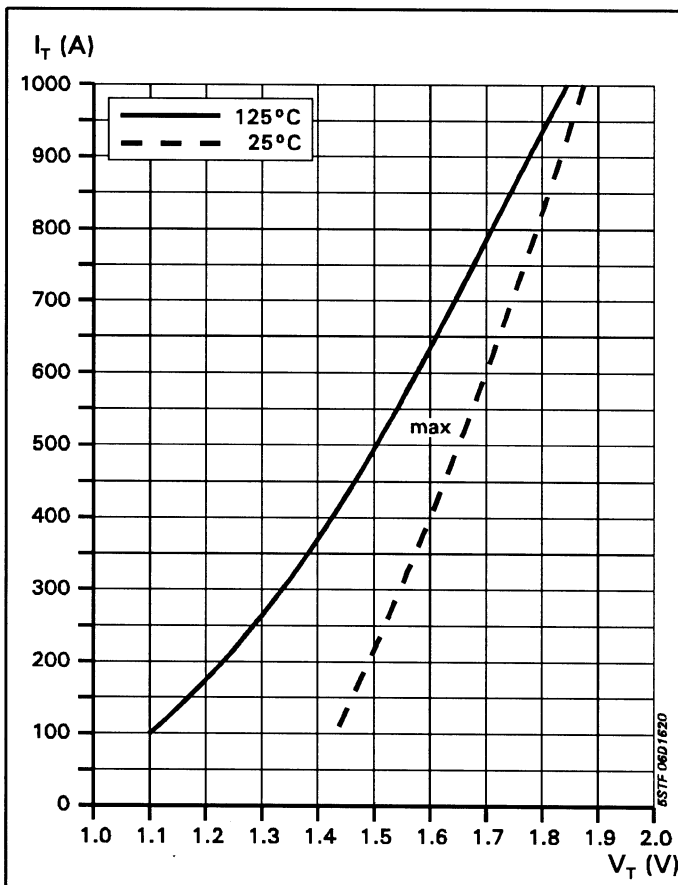

Fig.2 On-state characteristics.

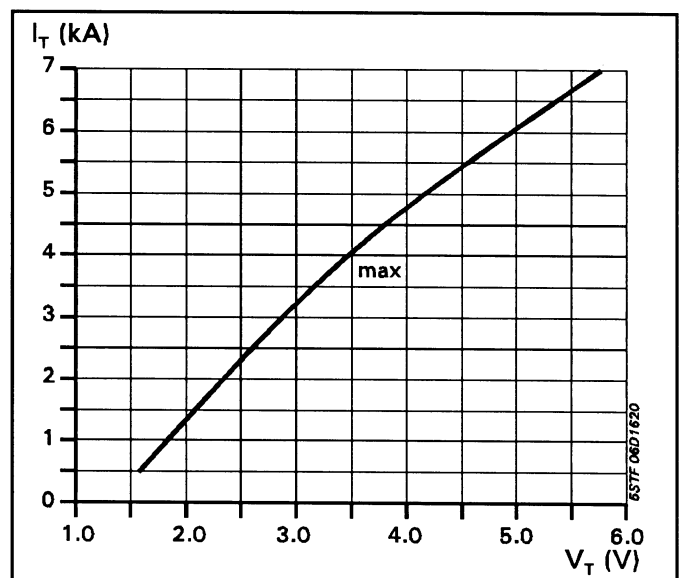

Fig.3 On-state characteristics.

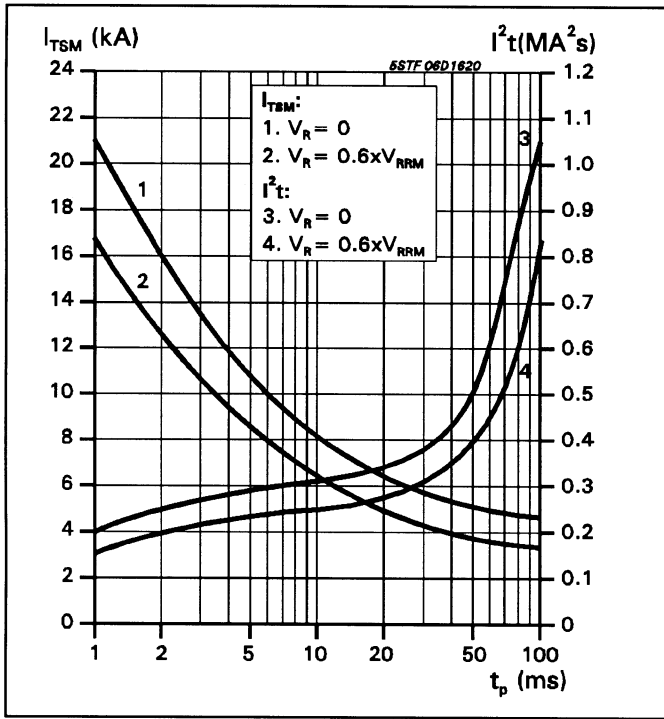

Fig.4 Surge on-state current vs pulse length. Half-sine wave.

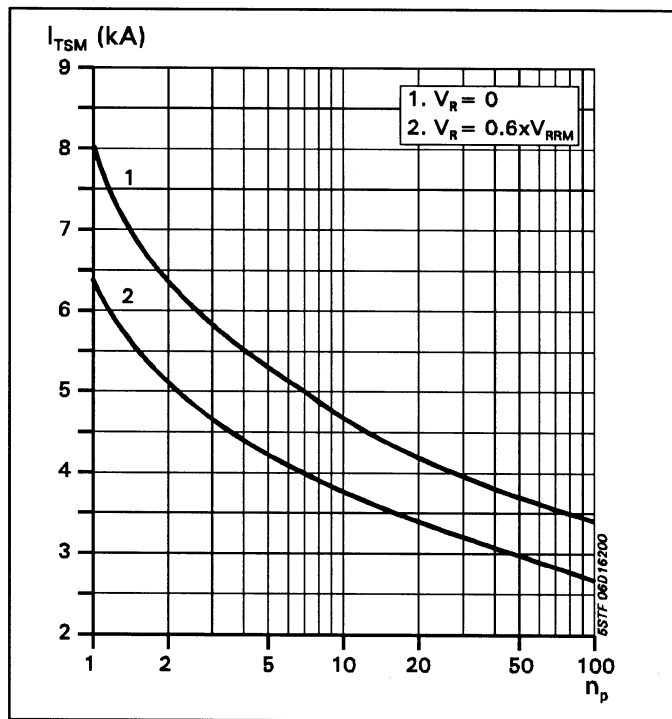

Fig.5 Surge on-state current vs number of pulses. Half-sine wave, 10ms, 50Hz.

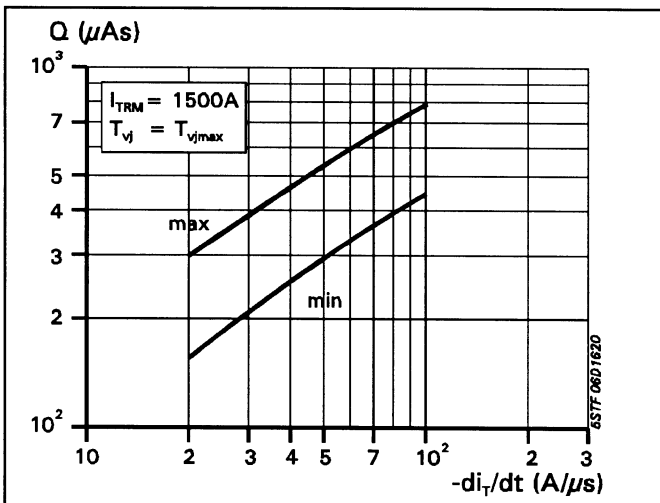

Fig.6 Recovery charge vs decay rate of on-state current.

