



# 5SDF 12T2505

Old part no. DM 818C-1200-25

## Fast Recovery Diode

### Properties

- Optimized recovery characteristics
- Industry standard housing

### Applications

- suited for GTO applications
- Snubber diode
- Freewheeling diode

### Key Parameters

$V_{RRM}$	=	2 500	V
$I_{FAVm}$	=	1 256	A
$I_{FSM}$	=	19 000	A
$V_{TO}$	=	1.195	V
$r_T$	=	0.245	mΩ

### Types

	$V_{RRM}$
<b>5SDF 12T2505</b>	<b>2500 V</b>
Conditions: $T_j = -40 \div 125 \text{ }^\circ\text{C}$ , half sine waveform, $f = 50 \text{ Hz}$	

### Mechanical Data

$F_m$	Mounting force	$22 \pm 2 \text{ kN}$
$m$	Weight	<b>0.44 kg</b>
$D_s$	Surface creepage distance	<b>22 mm</b>
$D_a$	Air strike distance	<b>14 mm</b>

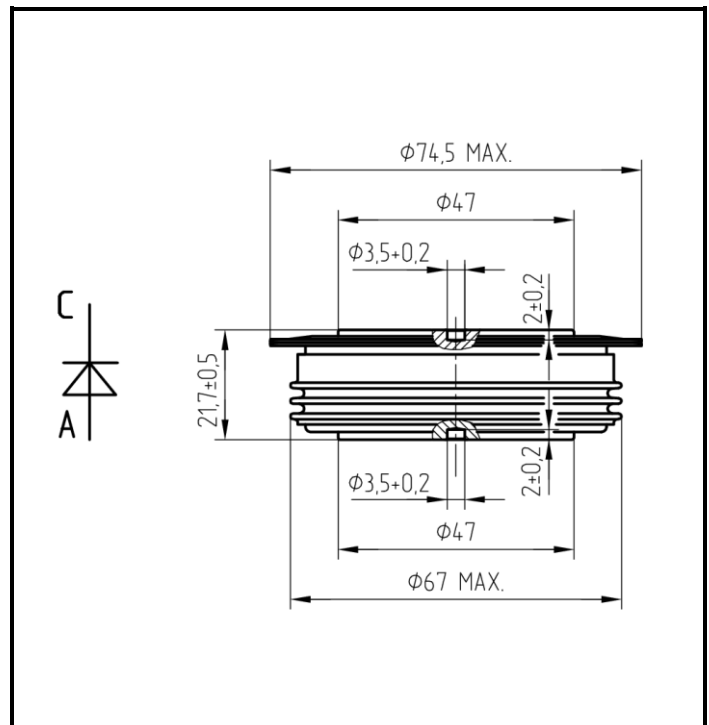


Fig. 1 Case



ABB s.r.o.

Novodvorska 1768/138a, 142 21 Praha 4, Czech Republic

tel.: +420 261 306 250, <http://www.abb.com/semiconductors>

<b>Maximum Ratings</b>		<b>Maximum Limits</b>	<b>Unit</b>	
$V_{RRM}$	<b>Repetitive peak reverse voltage</b> $T_j = -40 \div 125 \text{ }^\circ\text{C}$	<b>2 500</b>	<b>V</b>	
$I_{FAVm}$	<b>Average forward current</b> $T_c = 85 \text{ }^\circ\text{C}$	<b>1 256</b>	<b>A</b>	
$I_{FRMS}$	<b>RMS forward current</b> $T_c = 85 \text{ }^\circ\text{C}$	<b>1 973</b>	<b>A</b>	
$I_{RRM}$	<b>Repetitive reverse current</b> $V_R = V_{RRM}$	<b>50</b>	<b>mA</b>	
$I_{FSM}$	<b>Non repetitive peak surge current</b> $V_R = 0 \text{ V, half sine pulse}$	$t_p = 8.3 \text{ ms}$	<b>20 300</b>	<b>A</b>
		$t_p = 10 \text{ ms}$	<b>19 000</b>	<b>A</b>
$I^2t$	<b>Limiting load integral</b> $V_R = 0 \text{ V, half sine pulse}$	$t_p = 8.3 \text{ ms}$	<b>1 710 000</b>	<b>A<sup>2</sup>s</b>
		$t_p = 10 \text{ ms}$	<b>1 805 000</b>	<b>A<sup>2</sup>s</b>
$T_{jmin} - T_{jmax}$	<b>Operating temperature range</b>	<b>-40 <math>\div</math> 125</b>	<b><math>^\circ\text{C}</math></b>	
$T_{STG}$	<b>Storage temperature range</b>	<b>-40 <math>\div</math> 125</b>	<b><math>^\circ\text{C}</math></b>	

Unless otherwise specified  $T_j = 125 \text{ }^\circ\text{C}$

Characteristics		Value			Unit
		min	typ	max	
$V_{T0}$	<b>Threshold voltage</b>			1.195	V
$r_T$	<b>Forward slope resistance</b> $I_{F1} = 1\ 885\ A, I_{F2} = 5\ 655\ A$			0.245	m $\Omega$
$V_{FM}$	<b>Maximum forward voltage</b> $I_{FM} = 2\ 000\ A$			1.690	V
$Q_{rr}$	<b>Recovered charge</b> $V_R = 100\ V, I_{FM} = 1000\ A, di/dt = -80\ A/\mu s$		500	700	$\mu C$
$I_{rrM}$	<b>Reverse recovery maximum current</b> <i>the same conditions as at <math>Q_{rr}</math></i>		160	230	A
$t_{rr}$	<b>Reverse recovery time</b> <i>the same conditions as at <math>Q_{rr}</math></i>			5.0	$\mu s$
<b>S</b>	<b>Soft factor, <math>S = t_s / t_f</math></b> $I_{FM} = 1\ 000\ A, di_f/dt = -200\ A/\mu s, V_R = 400\ V$		2.0		-
$I_{rrM}$	<b>Reverse recovery maximum current</b> <i>the same conditions as at S</i>			400	A
$V_{rrM}$	<b>Reverse recovery maximum voltage</b> <i>the same conditions as at S</i>			1 100	V

Unless otherwise specified  $T_j = 125\ ^\circ C$

Thermal Parameters			Value	Unit
$R_{thjc}$	Thermal resistance junction to case	double side cooling	15	K/kW
		anode side cooling	24	
		cathode side cooling	40	
$R_{thch}$	Thermal resistance case to heatsink	double side cooling	4	K/kW
		single side cooling	8	

Transient Thermal Impedance						
<b>Analytical function for transient thermal impedance</b>  $Z_{thjc} = \sum_{i=1}^5 R_i (1 - \exp(-t/\tau_i))$	$i$	1	2	3	4	5
	$\tau_i$ (s)	0.6937	0.2040	0.0452	0.0040	0.0005
	$R_i$ (K/kW)	6.04	3.83	3.76	1.31	0.07
Conditions: $F_m = 22 \pm 2$ kN, Double side cooled						
<b>Correction for periodic waveforms</b>						
180° sine: 1.3 K/kW 180° rectangular: 1.7 K/kW 120° rectangular: 2.9 K/kW 60° rectangular: 4.8 K/kW	Fig. 2 Dependence transient thermal impedance junction to case on square pulse					

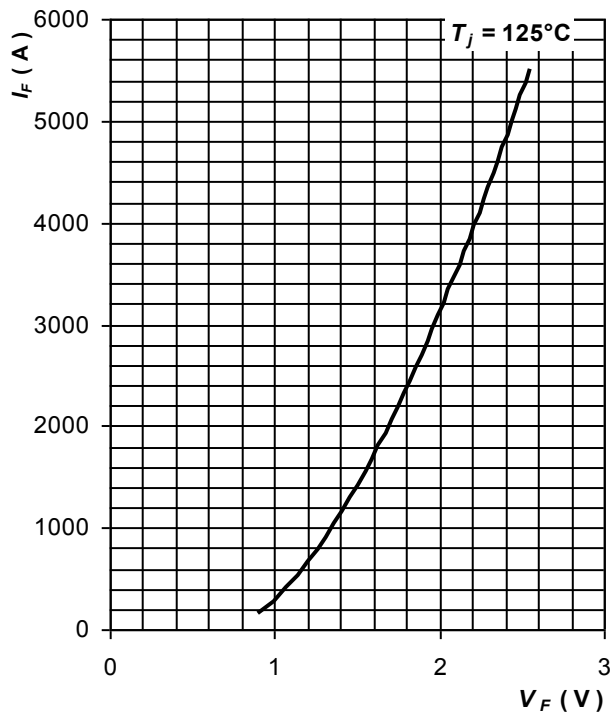
**Forward Characteristics**

Fig. 3 Maximum forward voltage drop characteristics

**Surge Characteristics**

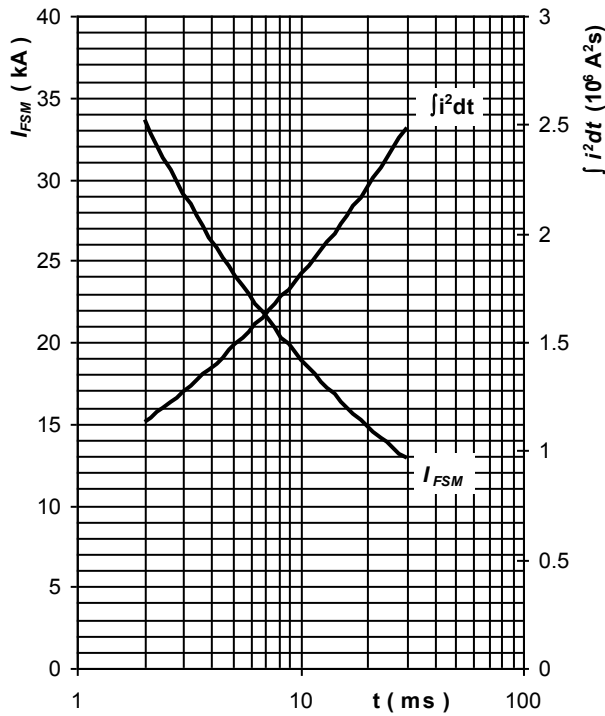


Fig. 4 Surge forward current vs. pulse length, half sine wave, single pulse,  $V_R = 0\text{ V}$ ,  $T_j = T_{jmax}$

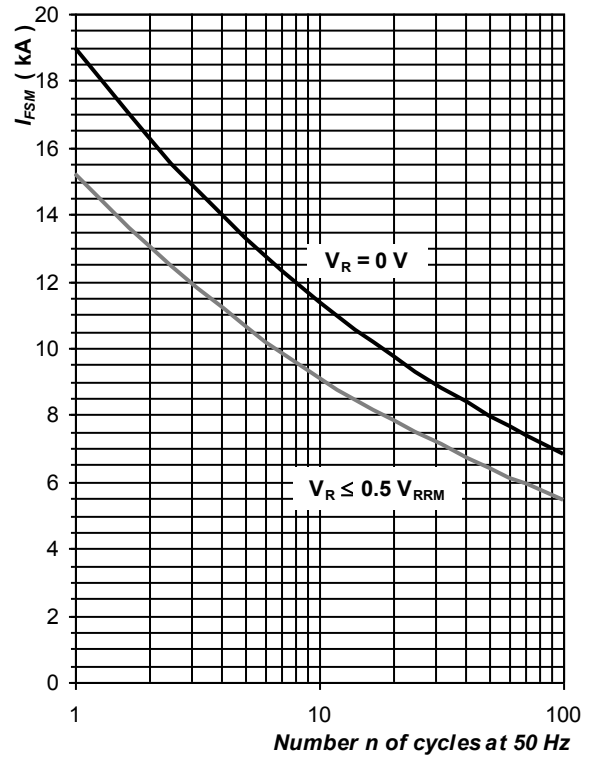


Fig. 5 Surge forward current vs. number of pulses, half sine wave,  $T_j = T_{jmax}$

**Power Loss and Maximum Case Temperature Characteristics**

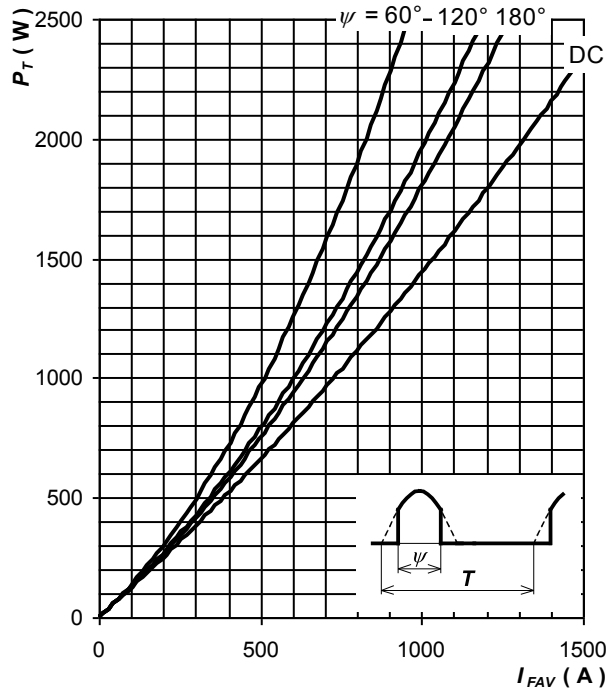


Fig. 6 Forward power loss vs. average forward current, sine waveform,  $f = 50$  Hz,  $T = 1/f$

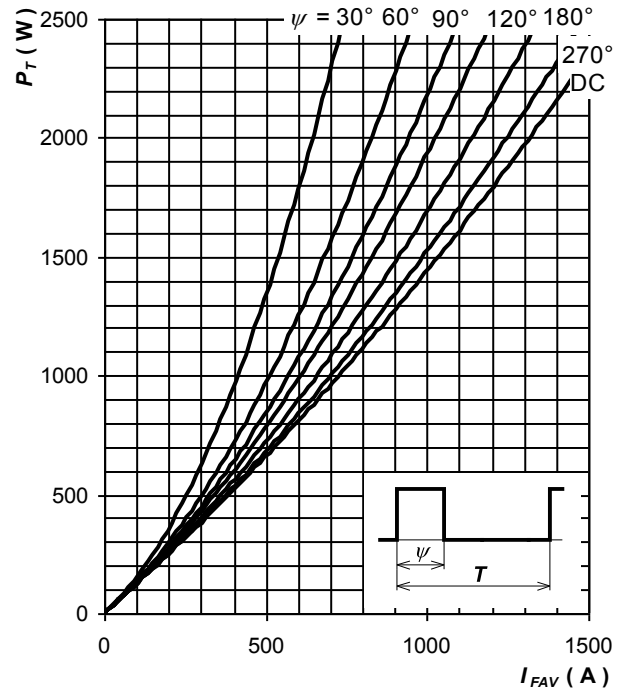


Fig. 7 Forward power loss vs. average forward current, square waveform,  $f = 50$  Hz,  $T = 1/f$

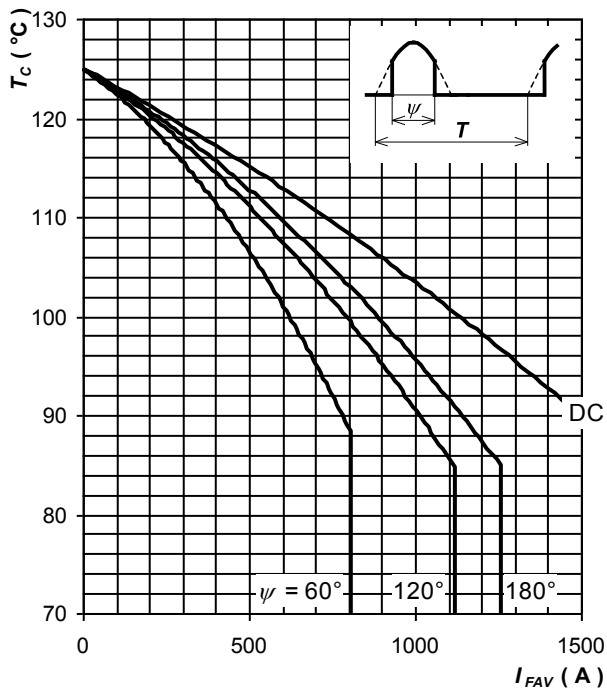


Fig. 8 Max. case temperature vs. aver. forward current, sine waveform,  $f = 50$  Hz,  $T = 1/f$

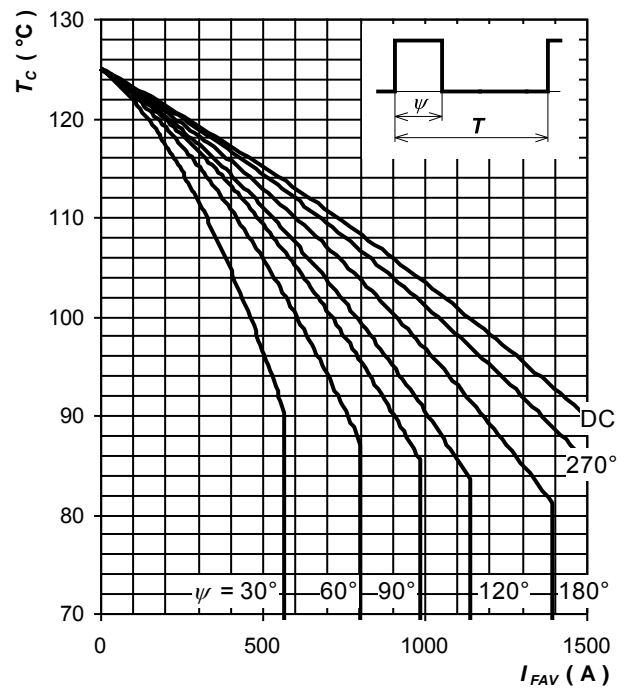


Fig. 9 Max. case temperature vs. aver. forward current, square waveform,  $f = 50$  Hz,  $T = 1/f$

Note 2: Figures number 6 ÷ 9 have been calculated without considering any forward and reverse recovery losses. They are valid for  $f = 50$  or  $60$  Hz operation.

**Forward Recovery Characteristics**

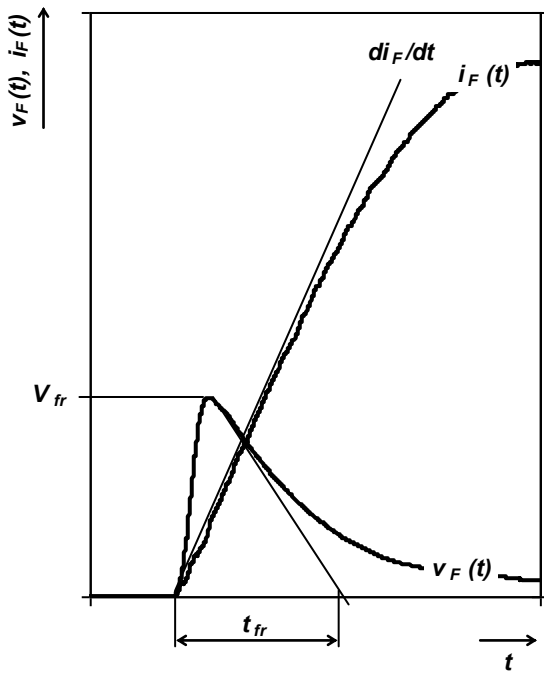


Fig. 10 Typical forward recovery voltage waveform when the diode is turned on with high  $di_F/dt$

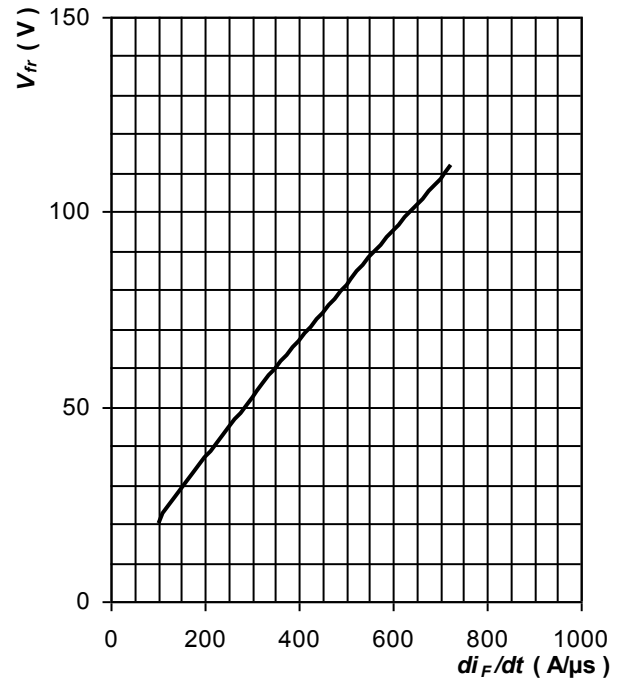


Fig. 11 Max. forward recovery voltage vs. rate of rise of forward current, trapezoid pulse,  $T_j = T_{jmax}$ ,  $t_{fr} \leq 10 \mu s$



**Reverse Recovery Characteristics**

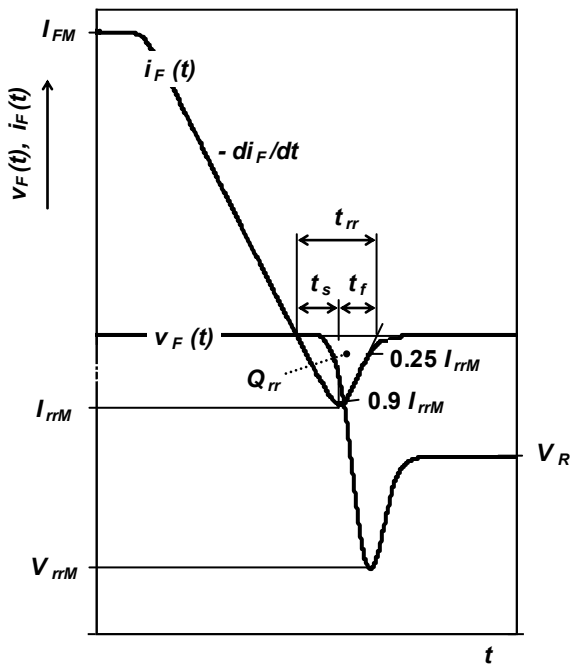


Fig. 12 Typical waveforms and definition of symbols at reverse recovery of a diode, inductive switching without RC snubber

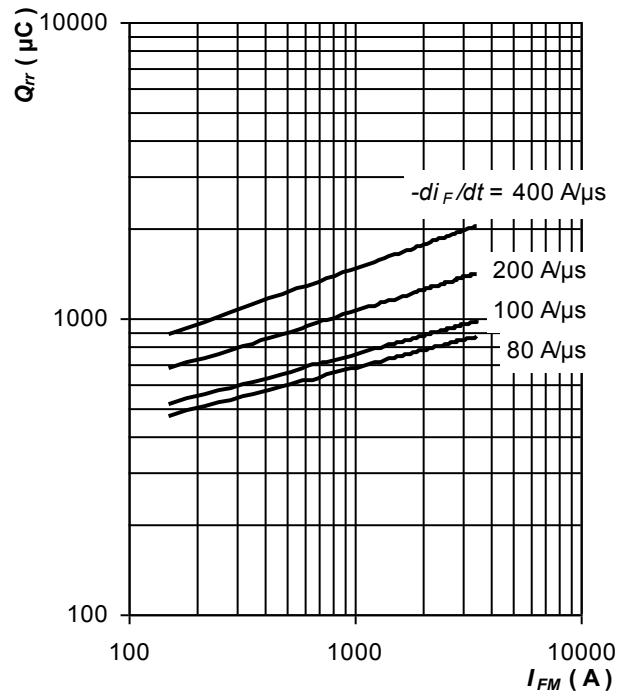


Fig. 13 Max. recovered charge vs. forward current, trapezoid pulse,  $T_j = T_{jmax}$

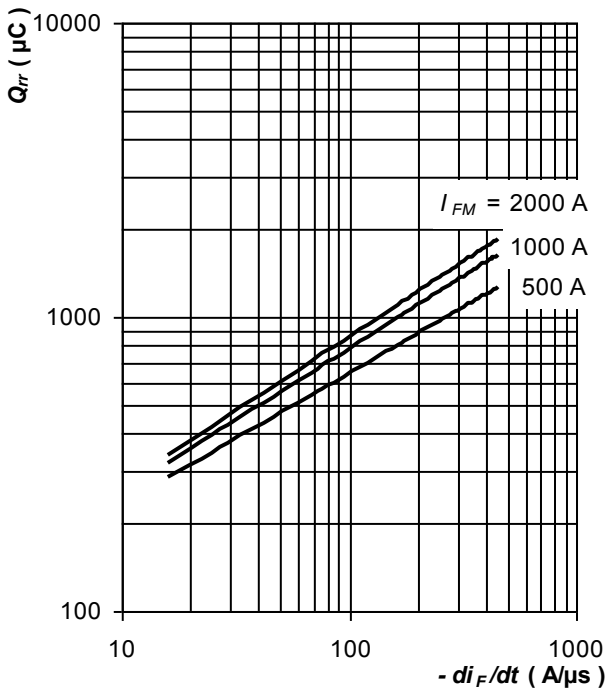


Fig. 14 Max. recovered charge vs. rate of fall of forward current, trapezoid pulse,  $T_j = T_{jmax}$

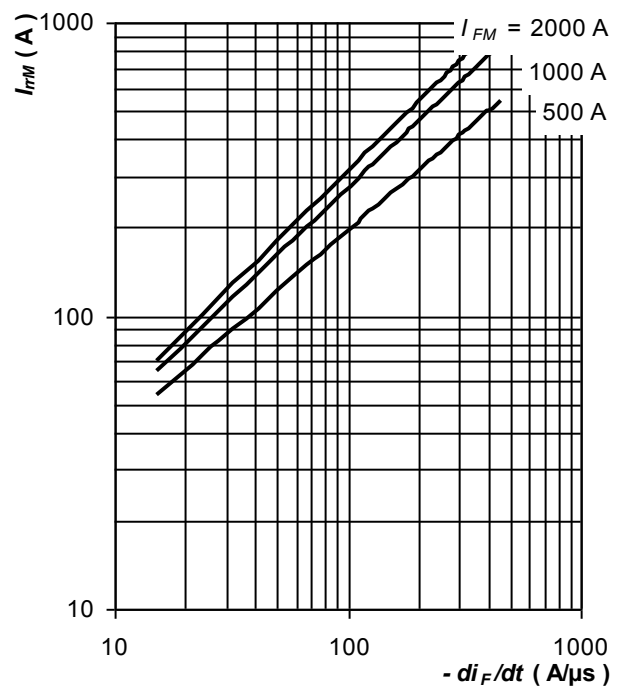


Fig. 15 Max. reverse recovery current vs. rate of fall of forward current, trapezoid pulse,  $T_j = T_{jmax}$

Notes:

ABB s.r.o., Novodvorska 1768/138a, 142 21 Praha 4, Czech Republic

ABB s.r.o. reserves the right to change the data contained herein at any time without notice