



5SDF 06T2504

Old part no. DM 827C-620-25

Fast Recovery Diode

Properties

- Optimized recovery characteristics
- Industry standard housing

Applications

- suited for GTO applications
- Snubber diode
- Freewheeling diode

Key Parameters

V_{RRM}	=	2 500	V
I_{FAVm}	=	615	A
I_{FSM}	=	10 000	A
V_{TO}	=	1.196	V
r_T	=	0.461	m Ω

Types

	V_{RRM}
5SDF 06T2504	2 500 V
Conditions:	$T_j = -40 \div 125$ °C, half sine waveform, $f = 50$ Hz

Mechanical Data

F_m	Mounting force	10 \pm 2 kN
m	Weight	0.20 kg
D_s	Surface creepage distance	20 mm
D_a	Air strike distance	14 mm

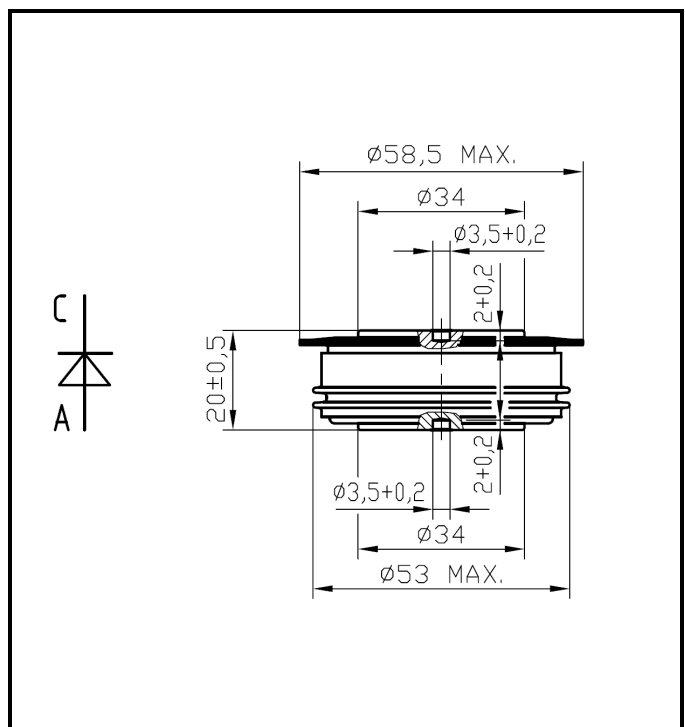


Fig. 1 Case



ABB s.r.o.

Novodvorska 1768/138a, 142 21 Praha 4, Czech Republic

tel.: +420 261 306 250, <http://www.abb.com/semiconductors>

Maximum Ratings		Maximum Limits	Unit	
V_{RRM}	Repetitive peak reverse voltage $T_j = -40 \div 125 \text{ }^\circ\text{C}$	2 500	V	
I_{FAVm}	Average forward current $T_c = 85 \text{ }^\circ\text{C}$	615	A	
I_{FRMS}	RMS forward current $T_c = 85 \text{ }^\circ\text{C}$	966	A	
I_{RRM}	Repetitive reverse current $V_R = V_{RRM}$	50	mA	
I_{FSM}	Non repetitive peak surge current $V_R = 0 \text{ V, half sine pulse}$	$t_p = 8.3 \text{ ms}$	10 700	A
		$t_p = 10 \text{ ms}$	10 000	A
$\int I^2 t$	Limiting load integral $V_R = 0 \text{ V, half sine pulse}$	$t_p = 8.3 \text{ ms}$	474 000	A²s
		$t_p = 10 \text{ ms}$	500 000	A²s
$T_{jmin} - T_{jmax}$	Operating temperature range	-40 \div 125	$^\circ\text{C}$	
T_{STG}	Storage temperature range	-40 \div 125	$^\circ\text{C}$	

Unless otherwise specified $T_j = 125 \text{ }^\circ\text{C}$

Characteristics		Value			Unit
		min	typ	max	
V_{T0}	Threshold voltage			1.196	V
r_T	Forward slope resistance $I_{F1} = 974 \text{ A}, I_{F2} = 2\,922 \text{ A}$			0.461	m Ω
V_{FM}	Maximum forward voltage $I_{FM} = 1\,000 \text{ A}$			1.660	V
Q_{rr}	Recovered charge $V_R = 100 \text{ V}, I_{FM} = 1000 \text{ A}, di/dt = -80 \text{ A}/\mu\text{s}$		260	400	μC
I_{rrM}	Reverse recovery maximum current <i>the same conditions as at Q_{rr}</i>		120	200	A
t_{rr}	Reverse recovery time <i>the same conditions as at Q_{rr}</i>			4.0	μs
S	Soft factor, $S = t_s / t_f$ $I_{FM} = 1\,000 \text{ A}, di_F/dt = -200 \text{ A}/\mu\text{s}, V_R = 400 \text{ V}$		2.0		-
I_{rrM}	Reverse recovery maximum current <i>the same conditions as at S</i>			400	A
V_{rrM}	Reverse recovery maximum voltage <i>the same conditions as at S</i>			1 100	V

Unless otherwise specified $T_j = 125 \text{ }^\circ\text{C}$

Thermal Parameters			Value	Unit
R_{thjc}	Thermal resistance junction to case	double side cooling	32	K/kW
		cathode side cooling	50	
		anode side cooling	88	
R_{thch}	Thermal resistance case to heatsink	double side cooling	8	K/kW
		single side cooling	16	

Transient Thermal Impedance														
Analytical function for transient thermal impedance $Z_{thjc} = \sum_{i=1}^5 R_i (1 - \exp(-t / \tau_i))$	i	1	2	3	4	5								
	τ_i (s)	0.7033	0.2185	0.0588	0.0042	0.0006								
	R_i (K/kW)	11.56	10.08	7.84	2.38	0.13								
Conditions: $F_m = 10 \pm 2$ kN, Double side cooled Correction for periodic waveforms	<table border="1"> <tbody> <tr> <td>180° sine:</td> <td>2.3 K/kW</td> </tr> <tr> <td>180° rectangular:</td> <td>3.1 K/kW</td> </tr> <tr> <td>120° rectangular:</td> <td>5.1 K/kW</td> </tr> <tr> <td>60° rectangular:</td> <td>8.7 K/kW</td> </tr> </tbody> </table>	180° sine:	2.3 K/kW	180° rectangular:	3.1 K/kW	120° rectangular:	5.1 K/kW	60° rectangular:	8.7 K/kW					
180° sine:	2.3 K/kW													
180° rectangular:	3.1 K/kW													
120° rectangular:	5.1 K/kW													
60° rectangular:	8.7 K/kW													
Fig. 2 Dependence transient thermal impedance junction to case on square pulse														

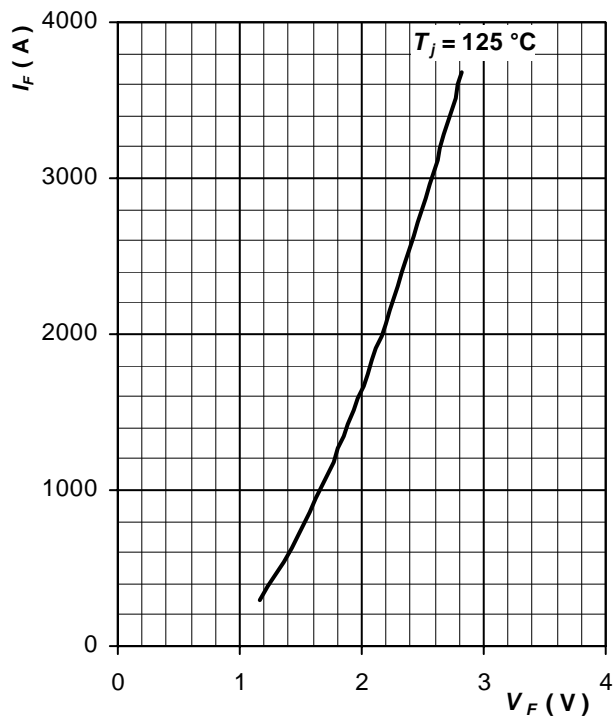
Forward Characteristics

Fig. 3 Maximum forward voltage drop characteristics

Surge Characteristics

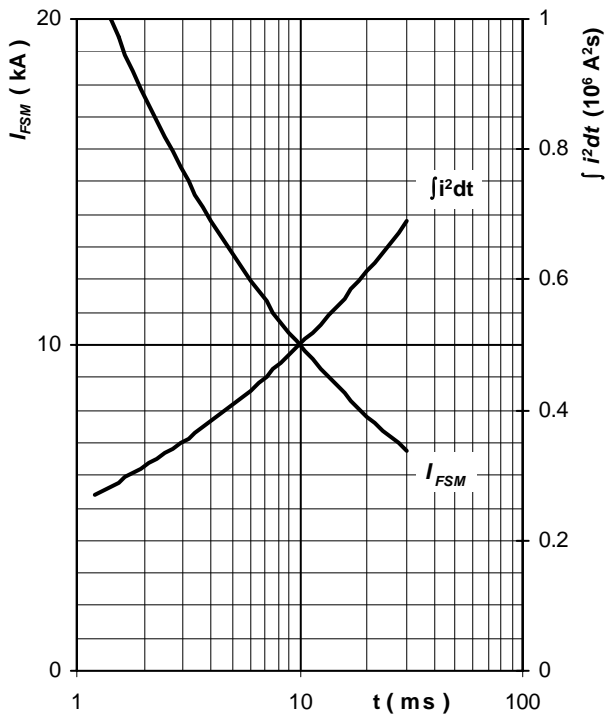


Fig. 4 Surge forward current vs. pulse length, half sine wave, single pulse, $V_R = 0$ V, $T_j = T_{jmax}$

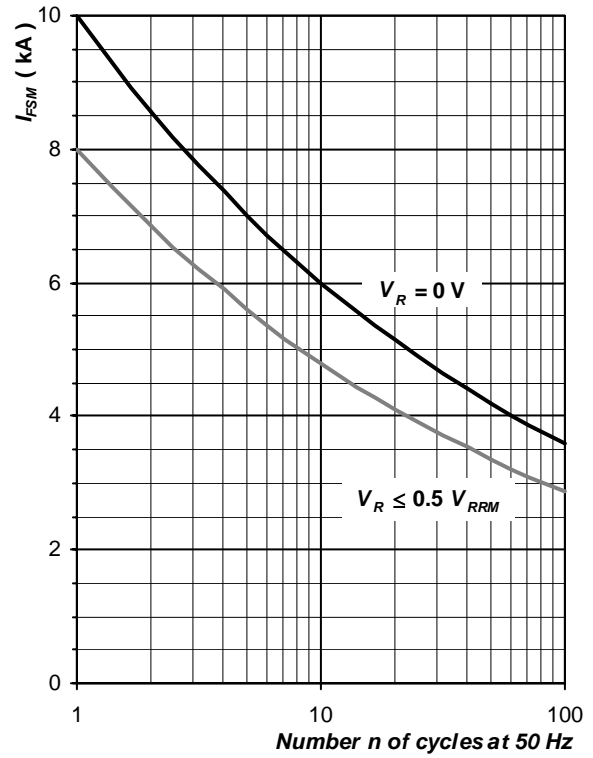


Fig. 5 Surge forward current vs. number of pulses, half sine wave, $T_j = T_{jmax}$

Power Loss and Maximum Case Temperature Characteristics

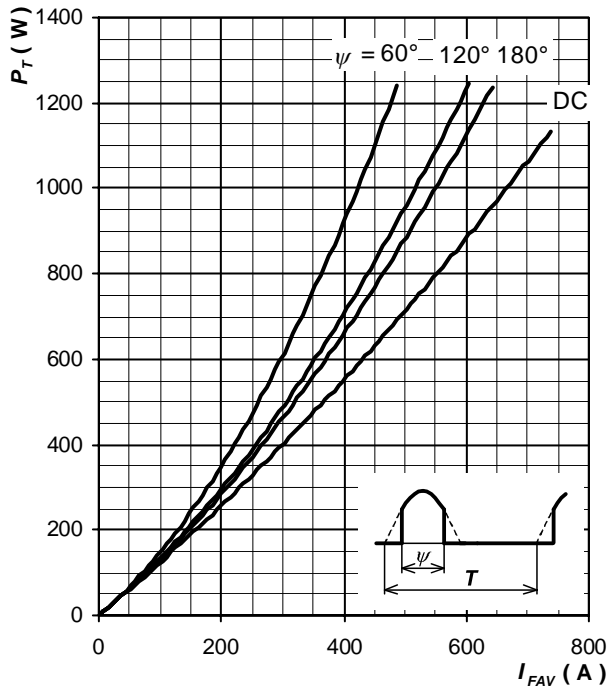


Fig. 6 Forward power loss vs. average forward current, sine waveform, $f = 50 \text{ Hz}$, $T = 1/f$

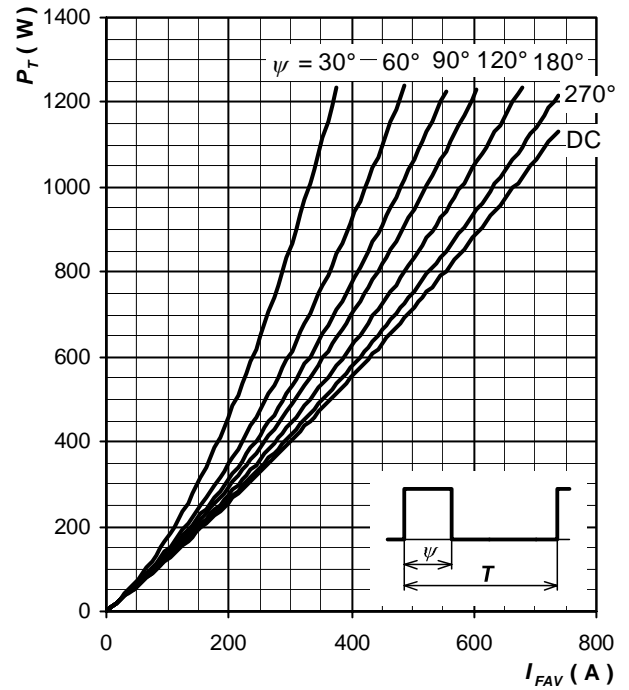


Fig. 7 Forward power loss vs. average forward current, square waveform, $f = 50 \text{ Hz}$, $T = 1/f$

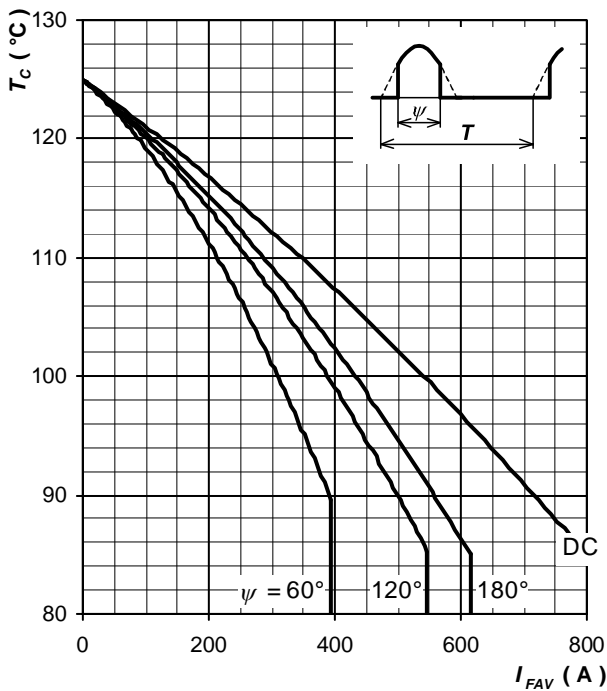


Fig. 8 Max. case temperature vs. aver. forward current, sine waveform, $f = 50 \text{ Hz}$, $T = 1/f$

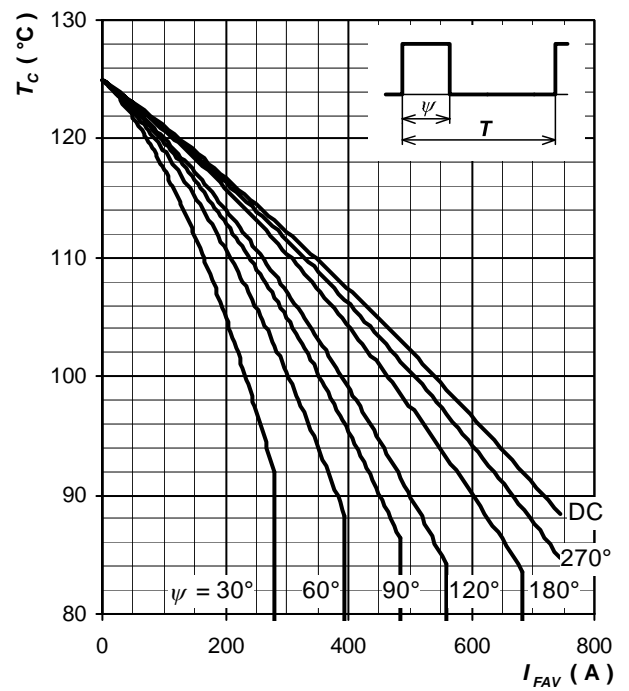


Fig. 9 Max. case temperature vs. aver. forward current, square waveform, $f = 50 \text{ Hz}$, $T = 1/f$

Note 2: Figures number 6 ÷ 9 have been calculated without considering any forward and reverse recovery losses. They are valid for $f = 50$ or 60 Hz operation.

Forward Recovery Characteristics

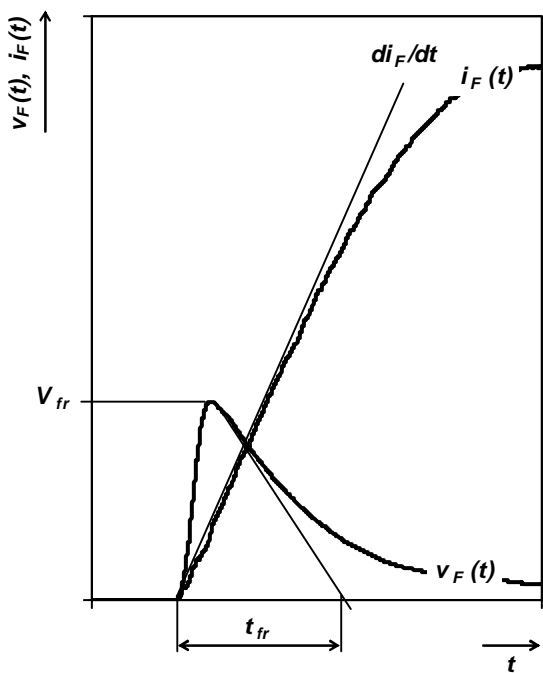


Fig. 10 Typical forward recovery voltage waveform when the diode is turned on with high di_F/dt

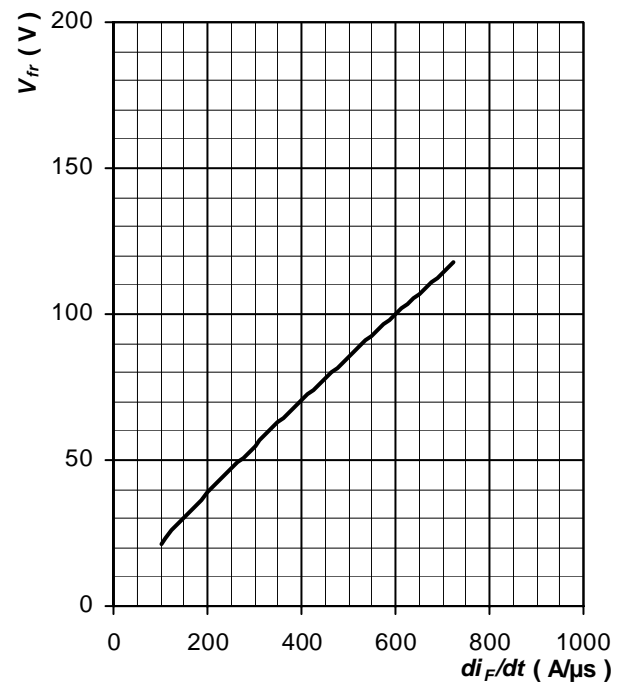


Fig. 11 Max. forward recovery voltage vs. rate of rise of forward current, trapezoid pulse, $T_j = T_{jmax}$, $t_{fr} \leq 10 \mu s$

Reverse Recovery Characteristics

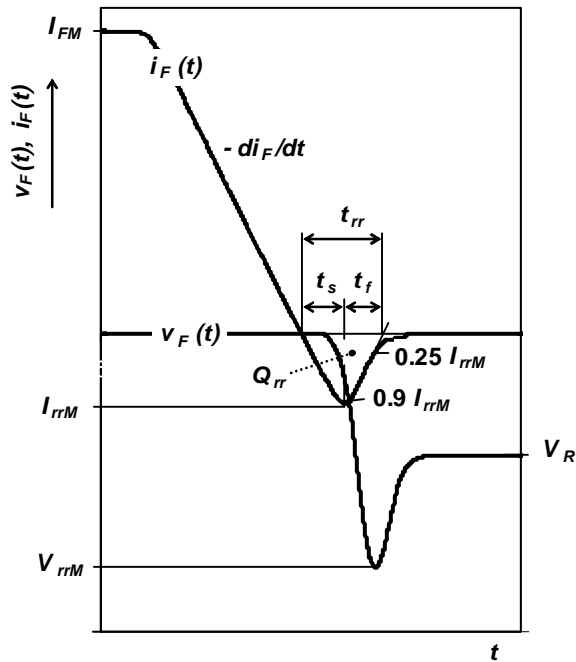


Fig. 12 Typical waveforms and definition of symbols at reverse recovery of a diode, inductive switching without RC snubber

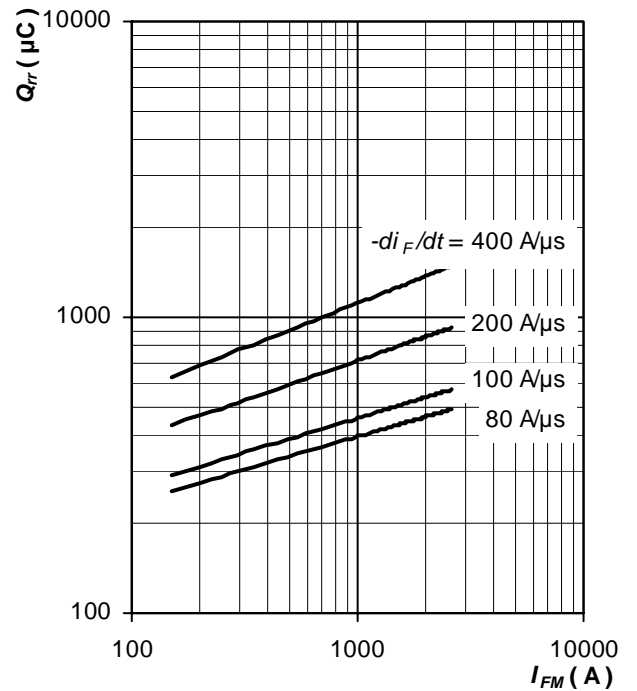


Fig. 13 Max. recovered charge vs. forward current, trapezoid pulse, $T_j = T_{jmax}$

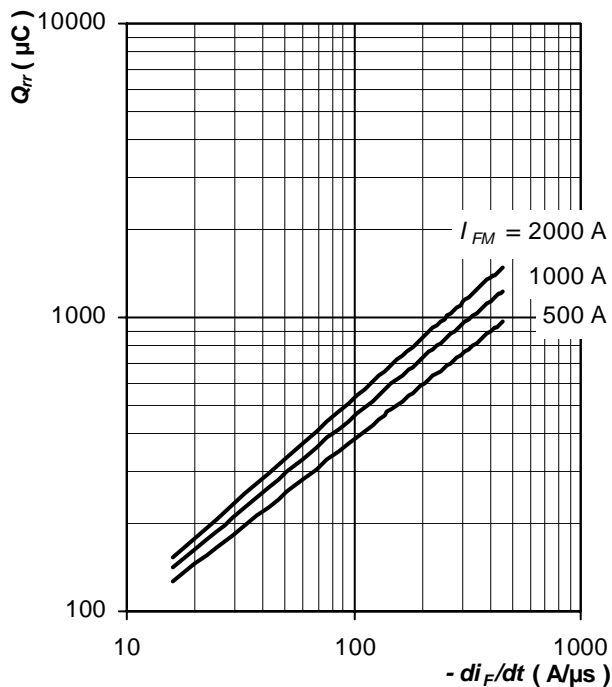


Fig. 14 Max. recovered charge vs. rate of fall of forward current, trapezoid pulse, $T_j = T_{jmax}$

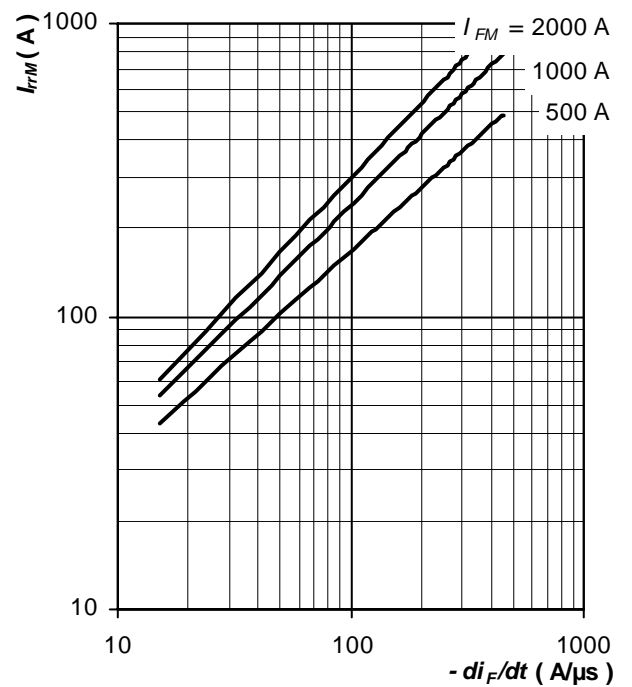


Fig. 15 Max. reverse recovery current vs. rate of fall of forward current, trapezoid pulse, $T_j = T_{jmax}$

Notes:

ABB s.r.o., Novodvorska 1768/138a, 142 21 Praha 4, Czech Republic

ABB s.r.o. reserves the right to change the data contained herein at any time without notice