



5SDF 04T4504

Old part no. DM 827C-360-45

Fast Recovery Diode

Properties

- § Optimized recovery characteristics
- § Industry standard housing

Applications

- § suited for GTO applications
- § Snubber diode
- § Freewheeling diode

Key Parameters

V_{RRM}	=	4 500	V
I_{FAVm}	=	361	A
I_{FSM}	=	6 000	A
V_{TO}	=	1.858	V
r_T	=	1.543	mΩ

Types

	V_{RRM}
5SDF 04T4504	4 500 V
5SDF 04T4004	4 000 V
Conditions: $T_j = -40 \div 125$ °C, half sine waveform, $f = 50$ Hz	

Mechanical Data

F_m	Mounting force	10 ± 2 kN
m	Weight	0.20 kg
D_s	Surface creepage distance	20 mm
D_a	Air strike distance	14 mm

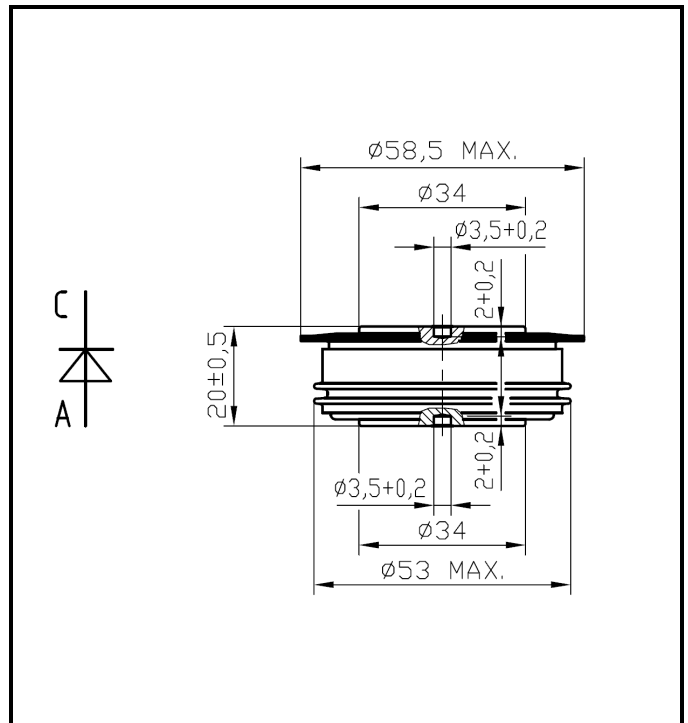


Fig. 1 Case



ABB s.r.o.

Novodvorska 1768/138a, 142 21 Praha 4, Czech Republic

tel.: +420 261 306 250, <http://www.abb.com/semiconductors>

Maximum Ratings			Maximum Limits	Unit
V_{RRM}	Repetitive peak reverse voltage $T_j = -40 \div 125 \text{ }^\circ\text{C}$	5SDF 04T4504 5SDF 04T4004	4 500 4 000	V
I_{FAVm}	Average forward current $T_c = 85 \text{ }^\circ\text{C}$		361	A
I_{FRMS}	RMS forward current $T_c = 85 \text{ }^\circ\text{C}$		567	A
I_{RRM}	Repetitive reverse current $V_R = V_{RRM}$		50	mA
I_{FSM}	Non repetitive peak surge current $V_R = 0 \text{ V, half sine pulse}$	$t_p = 8.3 \text{ ms}$	6 400	A
		$t_p = 10 \text{ ms}$	6 000	A
$\int i^2 t$	Limiting load integral $V_R = 0 \text{ V, half sine pulse}$	$t_p = 8.3 \text{ ms}$	170 000	A²s
		$t_p = 10 \text{ ms}$	180 000	A²s
$T_{jmin} - T_{jmax}$	Operating temperature range		-40 \div 125	$^\circ\text{C}$
T_{STG}	Storage temperature range		-40 \div 125	$^\circ\text{C}$

Unless otherwise specified $T_j = 125 \text{ }^\circ\text{C}$

Characteristics		Value			Unit
		min	typ	max	
V_{T0}	Threshold voltage			1.858	V
r_T	Forward slope resistance $I_{F1} = 565 \text{ A}, I_{F2} = 1\,696 \text{ A}$			1.543	mW
V_{FM}	Maximum forward voltage $I_{FM} = 1\,000 \text{ A}$			3.500	V
Q_{rr}	Recovered charge $V_R = 100 \text{ V}, I_{FM} = 1000 \text{ A}, di/dt = -80 \text{ A}/\mu\text{s}$		260	400	μC
I_{rrM}	Reverse recovery maximum current <i>the same conditions as at Q_{rr}</i>		120	200	A
t_{rr}	Reverse recovery time <i>the same conditions as at Q_{rr}</i>	group of t_{rr} L N P		3.2 4.0 5.0	μs
S	Soft factor, $S = t_s / t_f$ $I_{FM} = 1\,000 \text{ A}, di_F/dt = -200 \text{ A}/\mu\text{s}, V_R = 400 \text{ V}$		2.0		-
I_{rrM}	Reverse recovery maximum current <i>the same conditions as at S</i>			400	A
V_{rrM}	Reverse recovery maximum voltage <i>the same conditions as at S</i>			1\,100	V

Unless otherwise specified $T_j = 125 \text{ }^\circ\text{C}$

Thermal Parameters			Value	Unit
R_{thjc}	Thermal resistance junction to case	double side cooling	32	K/kW
		cathode side cooling	50	
		anode side cooling	88	
R_{thch}	Thermal resistance case to heatsink	double side cooling	8	K/kW
		single side cooling	16	

Transient Thermal Impedance

Analytical function for transient thermal impedance

$$Z_{thjc} = \sum_{i=1}^5 R_i (1 - \exp(-t / \tau_i))$$

Conditions:
 $F_m = 10 \pm 2$ kN, Double side cooled

Correction for periodic waveforms

180° sine:	2.3 K/kW
180° rectangular:	3.1 K/kW
120° rectangular:	5.1 K/kW
60° rectangular:	8.7 K/kW

i	1	2	3	4	5
τ_i (s)	0.7033	0.2185	0.0588	0.0042	0.0006
R_i (K/kW)	11.56	10.08	7.84	2.38	0.13

Fig. 2 Dependence transient thermal impedance junction to case on square pulse

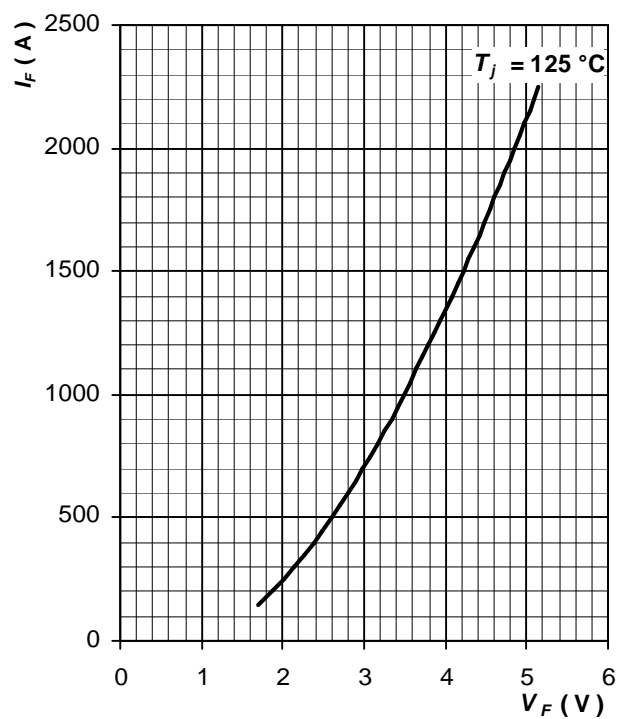
Forward Characteristics

Fig. 3 Maximum forward voltage drop characteristics

Surge Characteristics

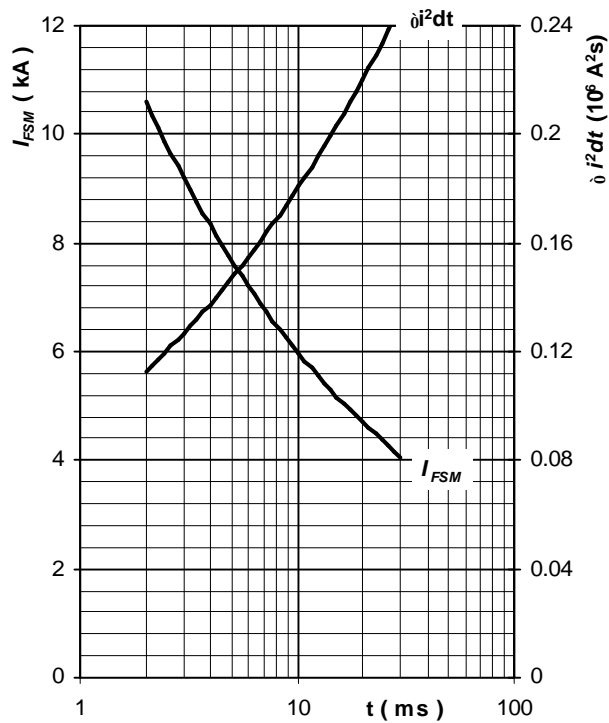


Fig. 4 Surge forward current vs. pulse length, half sine wave, single pulse, $V_R = 0 \text{ V}$, $T_j = T_{jmax}$

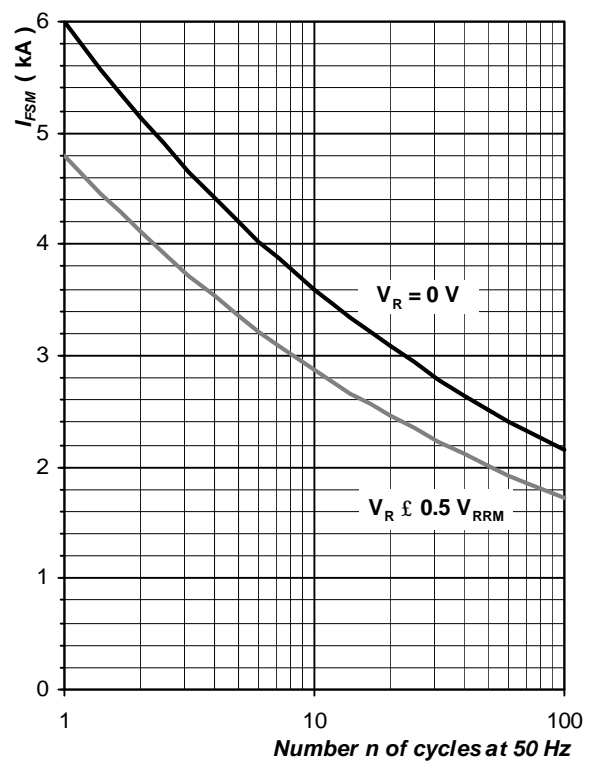


Fig. 5 Surge forward current vs. number of pulses, half sine wave, $T_j = T_{jmax}$

Power Loss and Maximum Case Temperature Characteristics

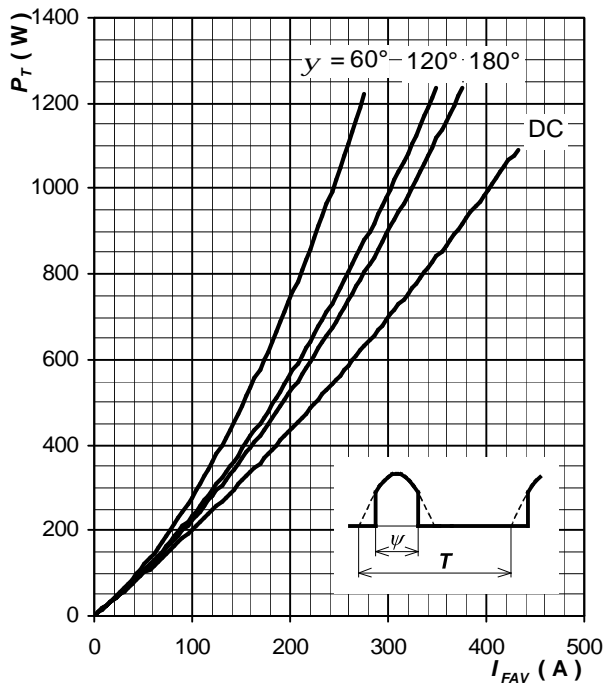


Fig. 6 Forward power loss vs. average forward current, sine waveform, $f = 50 \text{ Hz}$, $T = 1/f$

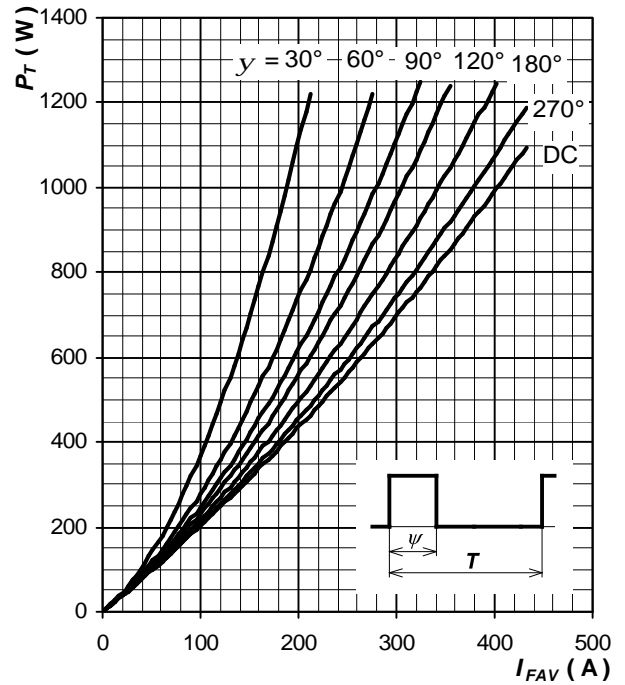


Fig. 7 Forward power loss vs. average forward current, square waveform, $f = 50 \text{ Hz}$, $T = 1/f$

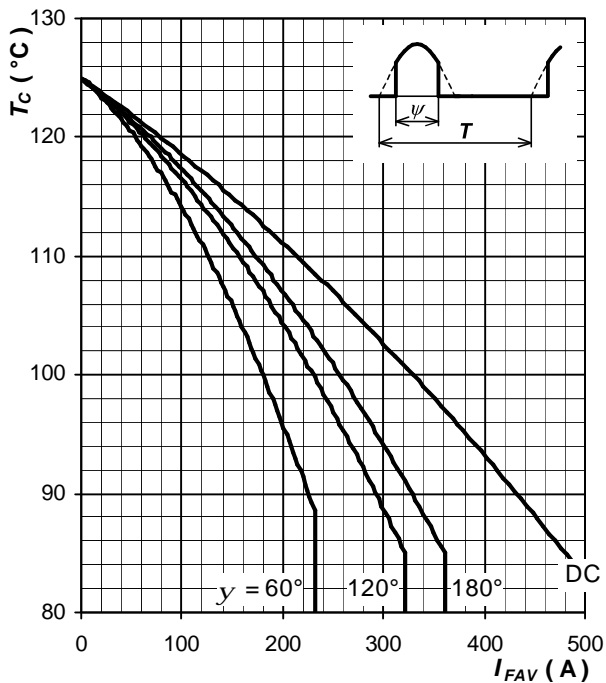


Fig. 8 Max. case temperature vs. aver. forward current, sine waveform, $f = 50 \text{ Hz}$, $T = 1/f$

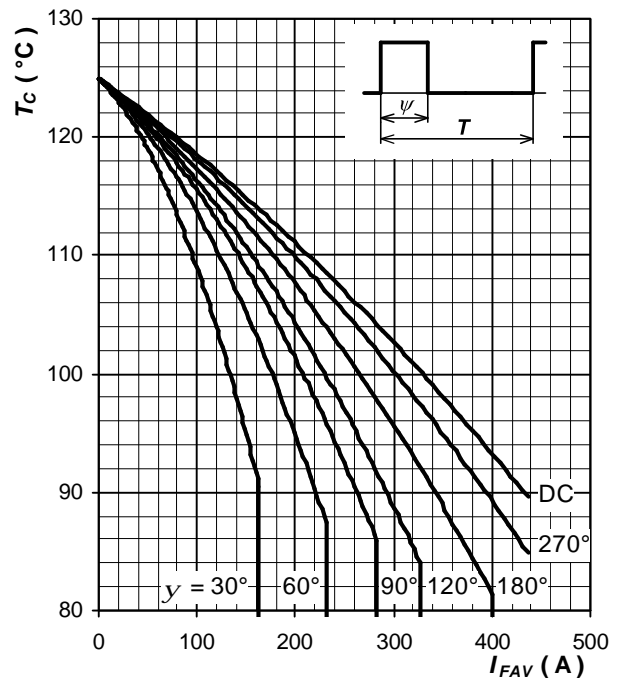


Fig. 9 Max. case temperature vs. aver. forward current, square waveform, $f = 50 \text{ Hz}$, $T = 1/f$

Note 2: Figures number 6 , 9 have been calculated without considering any forward and reverse recovery losses. They are valid for $f = 50$ or 60 Hz operation.

Forward Recovery Characteristics

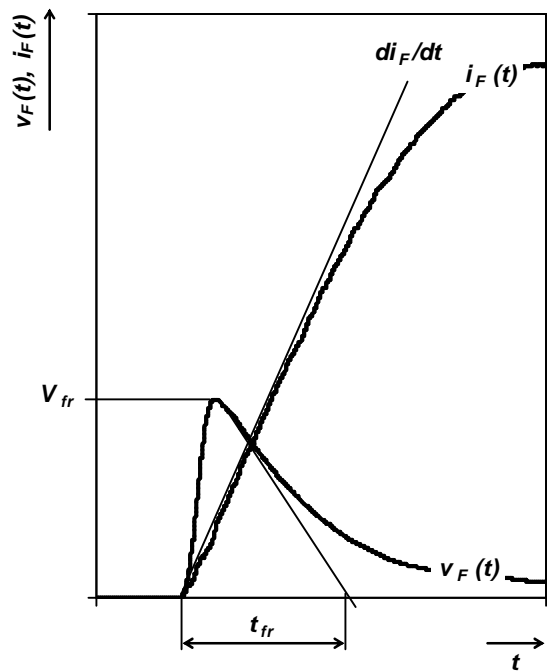


Fig. 10 Typical forward recovery voltage waveform when the diode is turned on with high di_F/dt

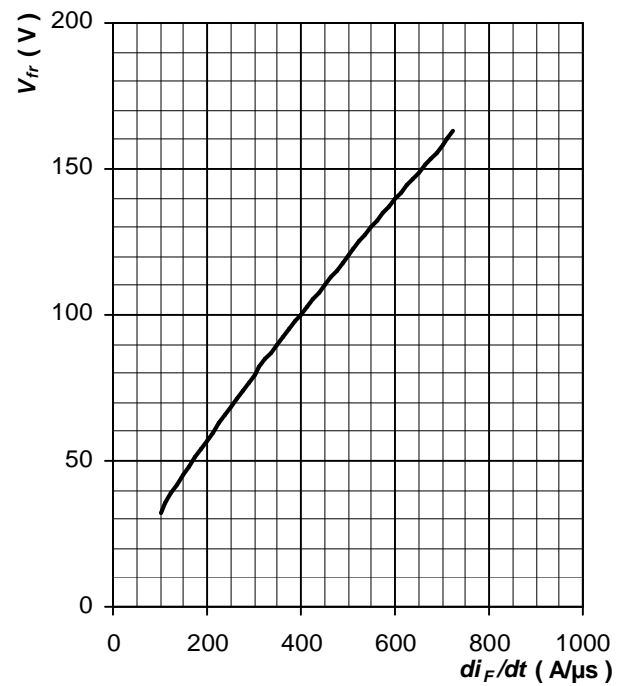


Fig. 11 Max. forward recovery voltage vs. rate of rise of forward current, trapezoid pulse, $T_j = T_{jmax}$, $t_{fr} \leq 10 \mu s$

Reverse Recovery Characteristics

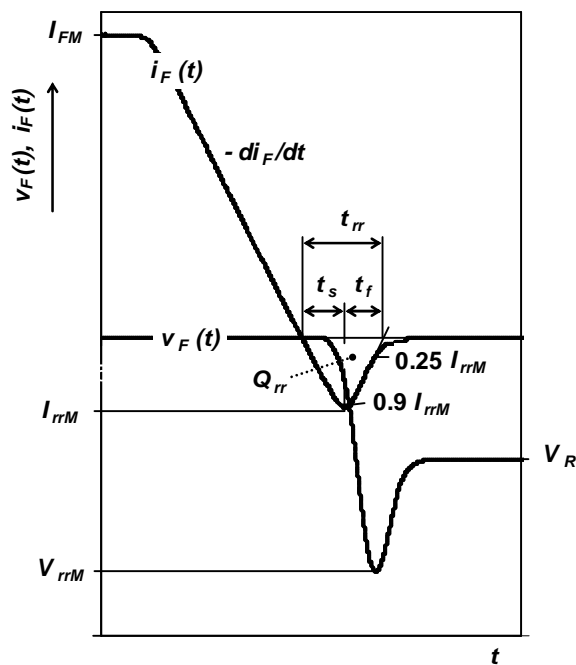


Fig. 12 Typical waveforms and definition of symbols at reverse recovery of a diode, inductive switching without RC snubber

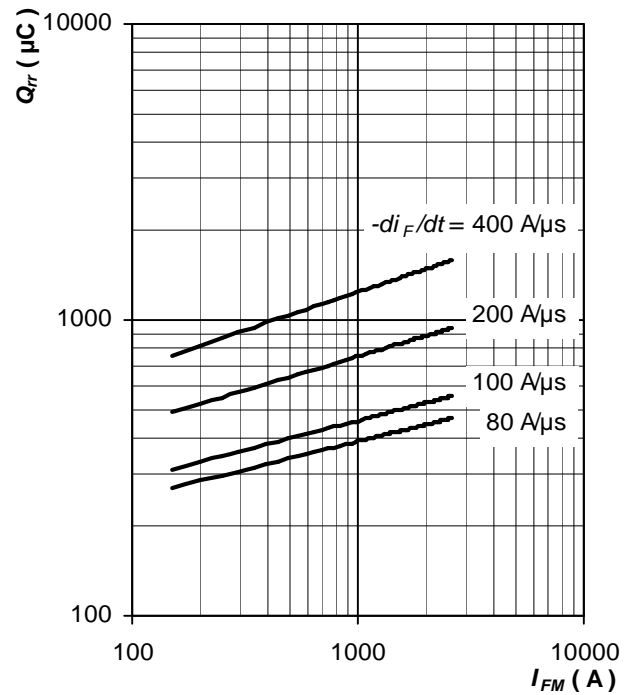


Fig. 13 Max. recovered charge vs. forward current, trapezoid pulse, $T_j = T_{jmax}$

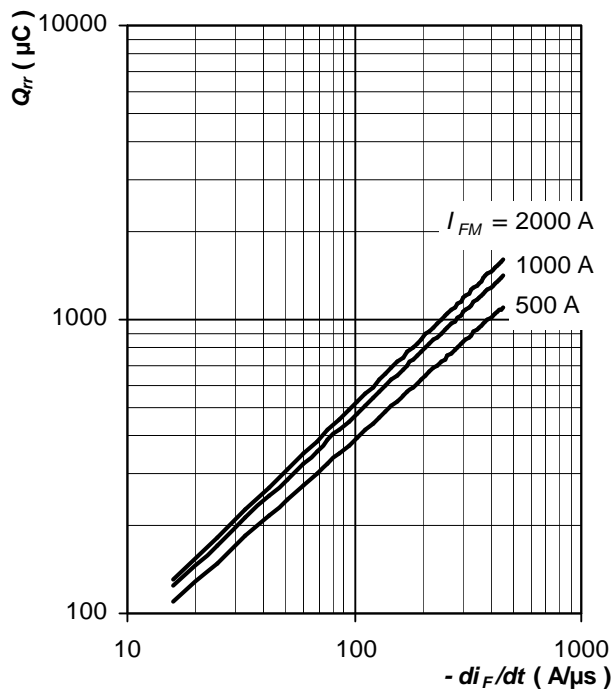


Fig. 14 Max. recovered charge vs. rate of fall of forward current, trapezoid pulse, $T_j = T_{jmax}$

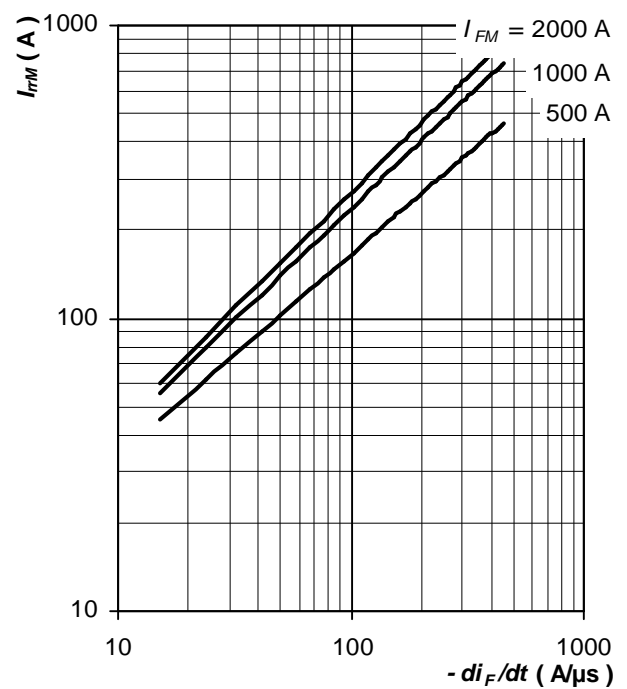


Fig. 15 Max. reverse recovery current vs. rate of fall of forward current, trapezoid pulse, $T_j = T_{jmax}$