

V_{RRM}	=	4500 V
I_{FAVM}	=	275 A
I_{FSM}	=	5 kA
V_{F0}	=	2.15 V
r_F	=	2.8 m Ω
V_{DClink}	=	2800 V

Fast Recovery Diode

5SDF 03D4502

PRELIMINARY

Doc. No. 5SYA1117-02 Sep. 01

- Patented free-floating technology
- Industry standard housing
- Cosmic radiation withstand rating
- Low on-state and switching losses
- Optimized to use in snubberless operation

Blocking

V_{RRM}	Repetitive peak reverse voltage	4500 V	Half sine wave, $t_p = 10$ ms, $f = 50$ Hz	
I_{RRM}	Repetitive peak reverse current	≤ 20 mA	$V_R = V_{RRM}$, $T_J = 115^\circ\text{C}$	
V_{DClink}	Permanent DC voltage for 100 FIT failure rate	2800 V	100% Duty	Ambient cosmic radiation at sea level in open air.
V_{DClink}	Permanent DC voltage for 100 FIT failure rate	3200 V	5% Duty	

Mechanical data (see Fig. 7)

F_m	Mounting force	min.	14 kN	
		max.	18 kN	
a	Acceleration: Device unclamped Device clamped		50 m/s ²	
			200 m/s ²	
m	Weight		0.25 kg	
D_s	Surface creepage distance	\geq	30 mm	
D_a	Air strike distance	\geq	20 mm	

ABB Semiconductors AG reserves the right to change specifications without notice.



On-state (see Fig. 1, 2)

I_{FAVM}	Max. average on-state current	275 A	Half sine wave, $T_c = 70^\circ\text{C}$	
I_{FRMS}	Max. RMS on-state current	435 A		
I_{FSM}	Max. peak non-repetitive surge current	5 kA	$t_p = 10\text{ ms}$	Before surge: $T_c = T_j = 115^\circ\text{C}$
		10 kA	$t_p = 1\text{ ms}$	
$\int I^2 dt$	Max. surge current integral	$\cdot 10^3\text{ A}^2\text{s}$	$t_p = 10\text{ ms}$	After surge: $V_R \approx 0\text{ V}$
		$50 \cdot 10^3\text{ A}^2\text{s}$	$t_p = 1\text{ ms}$	
V_F	Forward voltage drop	$\leq 3.9\text{ V}$	$I_F = 630\text{ A}$	$T_j = 115^\circ\text{C}$
V_{F0}	Threshold voltage	2.15 V	Approximation for	
r_F	Slope resistance	2.8 m Ω	$I_F = 200 \dots 1000\text{ A}$	

Turn-on

V_{fr}	Peak forward recovery voltage	$\leq 370\text{ V}$	$di/dt = 1000\text{ A}/\mu\text{s}$, $T_j = 115^\circ\text{C}$
----------	-------------------------------	---------------------	---

Turn-off (see Fig. 3, 4)

di/dt_{crit}	Max. decay rate of on-state current	$\leq 300\text{ A}/\mu\text{s}$	$I_F = 630\text{ A}$, $V_{Dclink} = 2800\text{ V}$	$T_j = 115^\circ\text{C}$
I_{rr}	Reverse recovery current	$\leq 355\text{ A}$		
Q_{rr}	Reverse recovery charge	$\leq 930\text{ }\mu\text{C}$		
E_{rr}	Turn-off energy	$\leq 1.8\text{ J}$		

Thermal

T_j	Operating junction temperature range	-40...115 $^\circ\text{C}$		
T_{stg}	Storage temperature range	-40...125 $^\circ\text{C}$		
R_{thJC}	Thermal resistance junction to case	$\leq 80\text{ K/KW}$	Anode side cooled	$F_m = 14 \dots 18\text{ kN}$
		$\leq 80\text{ K/KW}$	Cathode side cooled	
		$\leq 40\text{ K/KW}$	Double side cooled	
R_{thCH}	Thermal resistance case to heatsink	$\leq 16\text{ K/KW}$	Single side cooled	
		$\leq 8\text{ K/KW}$	Double side cooled	

Analytical function for transient thermal impedance.

$$Z_{thJC}(t) = \sum_{i=1}^n R_i (1 - e^{-t/\tau_i})$$

i	1	2	3	4
$R_i(\text{K/KW})$	20.95	10.57	7.15	1.33
$\tau_i(\text{s})$	0.396	0.072	0.009	0.0044
$F_m = 14 \dots 18\text{ kN}$ Double side cooled				

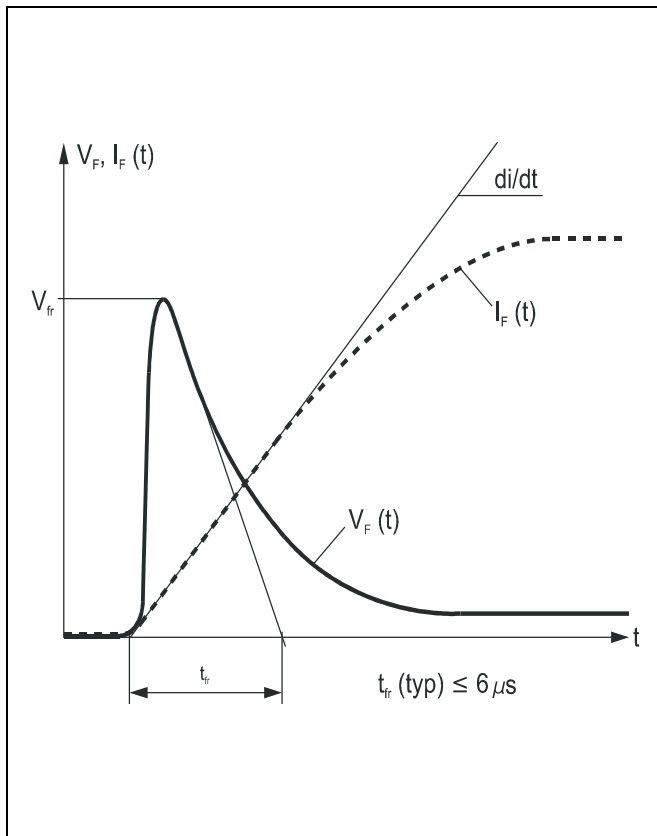

Fig. 1 Typical forward voltage waveform when the diode is turned on with high di/dt.

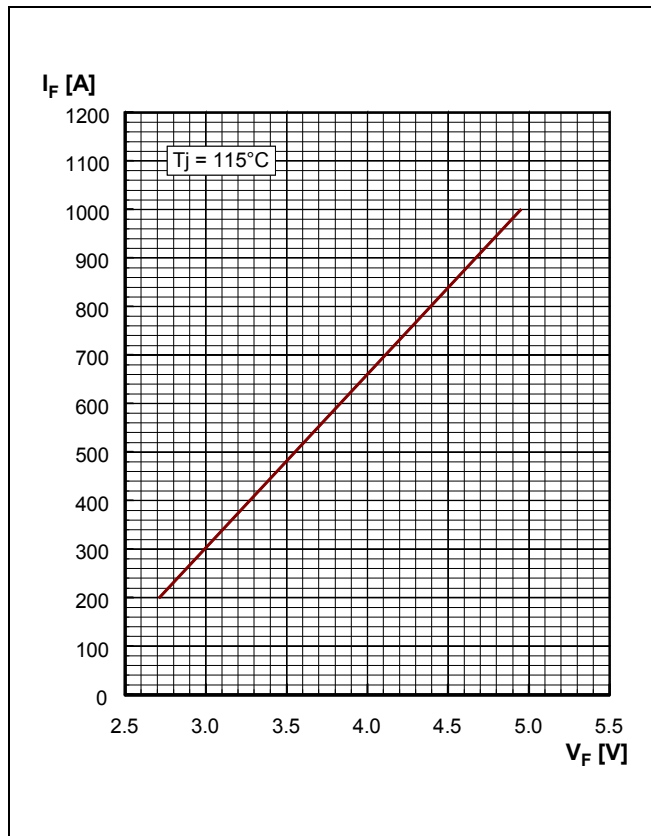

Fig. 2 Forward current vs. forward voltage.

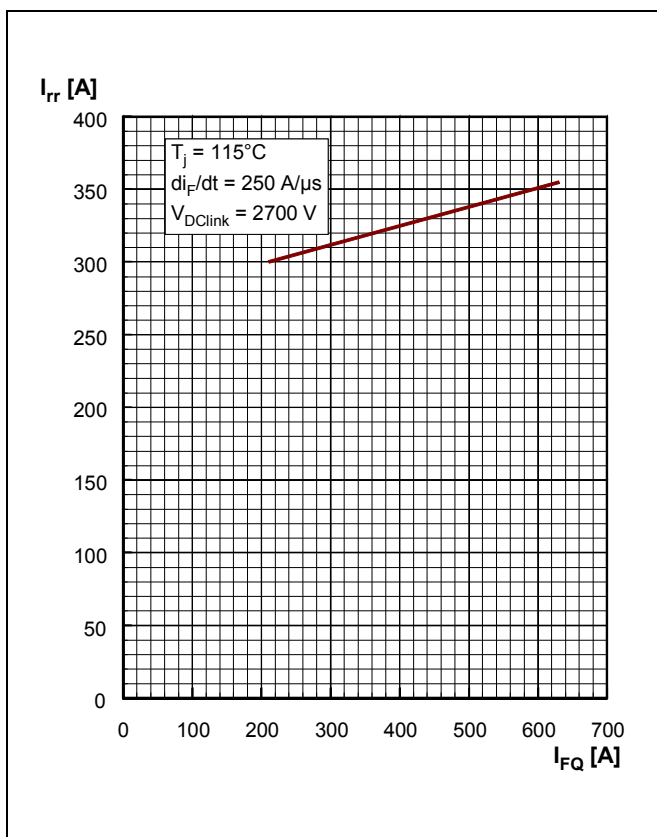

Fig. 3 Diode reverse recovery current vs. turn-off current.

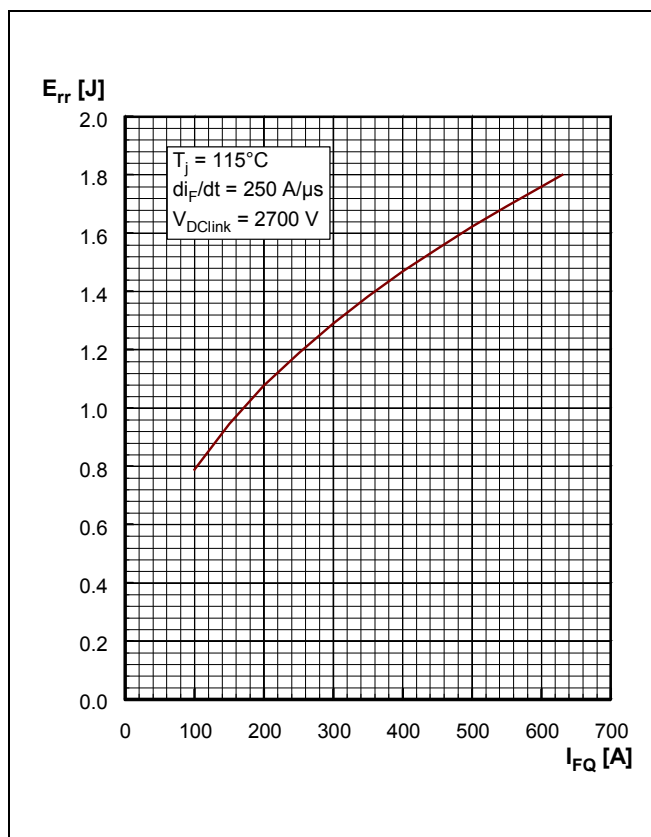

Fig. 4 Diode turn-off energy per pulse vs. turn-off current.

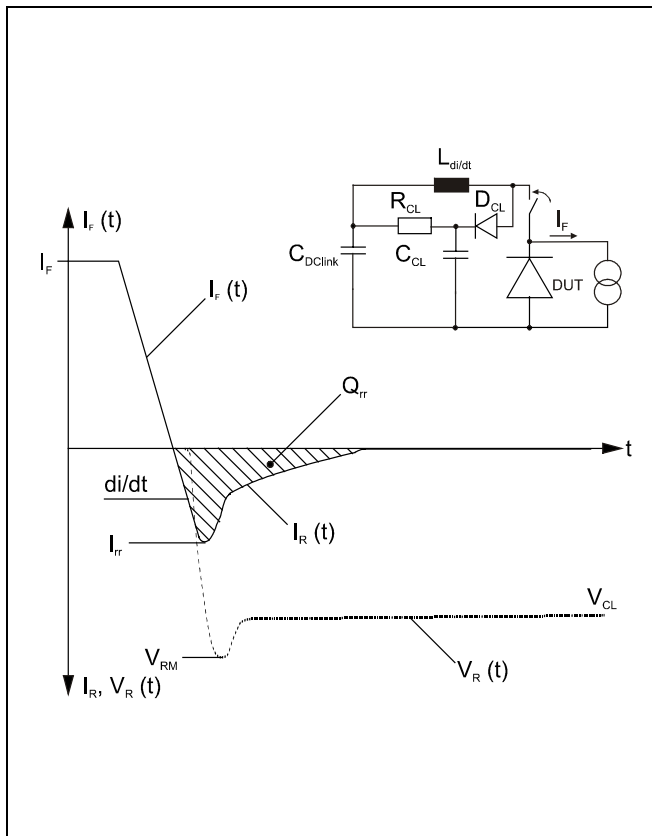

Fig. 5 Typical current and voltage waveforms at turn-off in a circuit with voltage clamp.

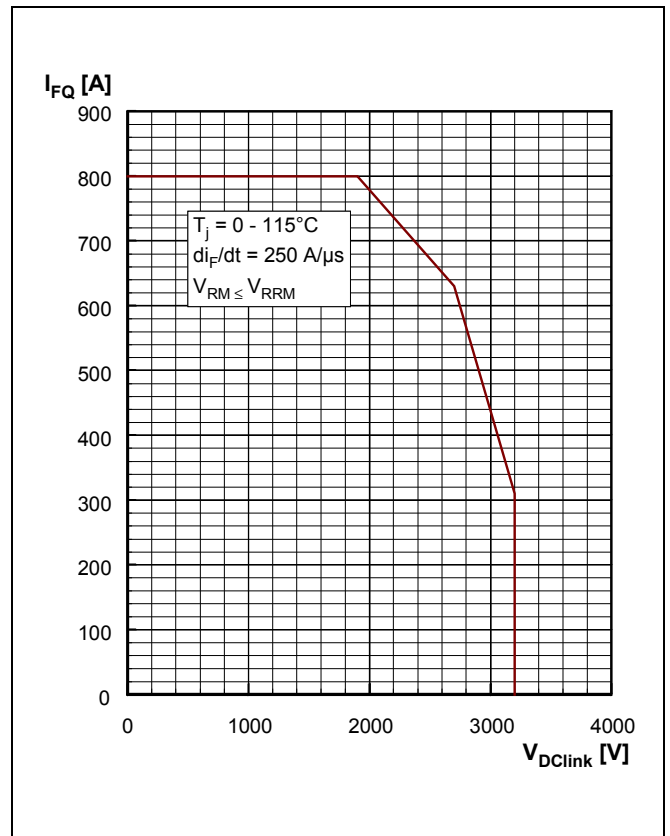

Fig. 6 Max. repetitive diode forward current.

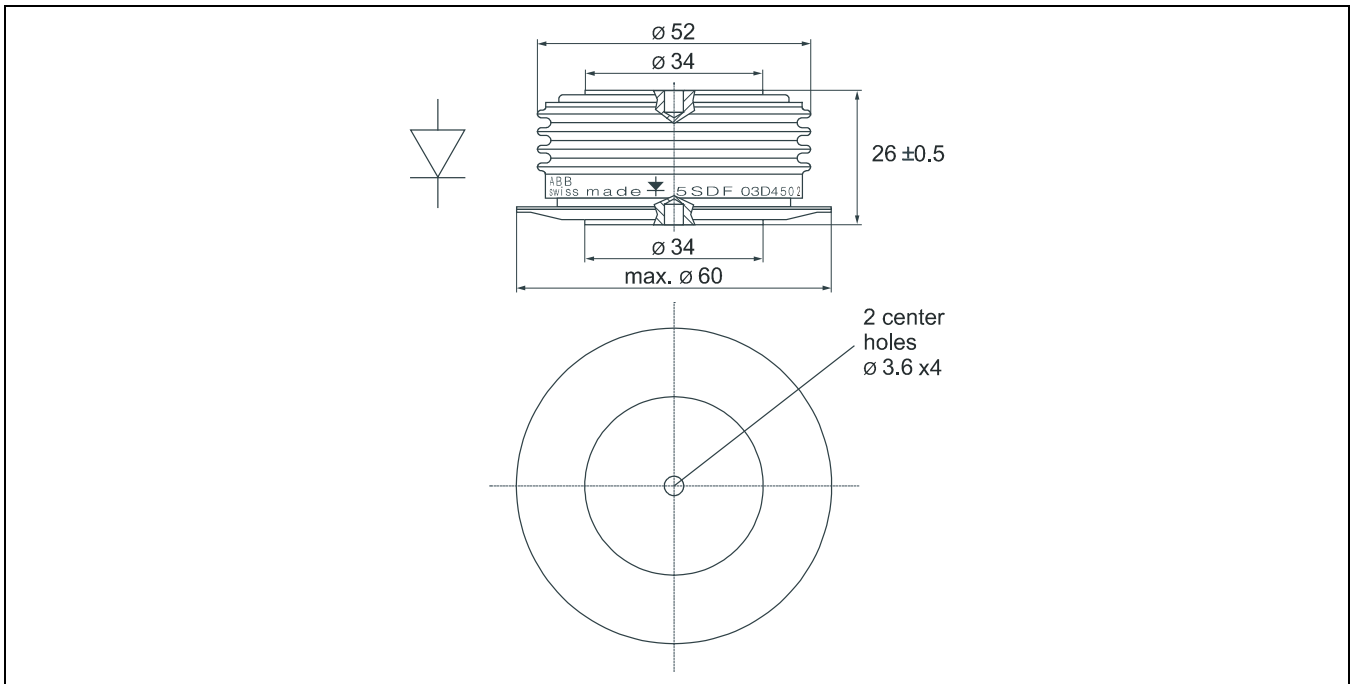

Fig. 7 Outline drawing. All dimensions are in millimeters and represent nominal values unless stated otherwise.

ABB Semiconductors AG reserves the right to change specifications without notice.

ABB

ABB Semiconductors AG
 Fabrikstrasse 3
 CH-5600 Lenzburg, Switzerland

Telephone +41 (0)62 888 6419
 Fax +41 (0)62 888 6306
 Email abbsem@ch.abb.com
 Internet www.abbsem.com

Doc. No. 5SYA1117-02 Sep. 01