



5SDA 16F3806

Old part no. DA 808-1620-38

Avalanche Diode

Properties

- low on-state voltage
- avalanche reverse characteristics
- high operational reliability
- suitable for parallel operation

Key Parameters

V_{RRM}	=	3 800	V
I_{FAVm}	=	1 620	A
I_{FSM}	=	20 500	A
V_{TO}	=	1.030	V
r_T	=	0.320	mΩ

Types

	V_{RRM}
5SDA 16F3806	3 800 V
Conditions:	$T_j = -40 \div 160 \text{ }^\circ\text{C}$, half sine waveform, $f = 50 \text{ Hz}$

Mechanical Data

F_m	Mounting force	$22 \pm 2 \text{ kN}$
m	Weight	0.46 kg
D_s	Surface creepage d stance	30 mm
D_a	Air strike distance	20.5 mm

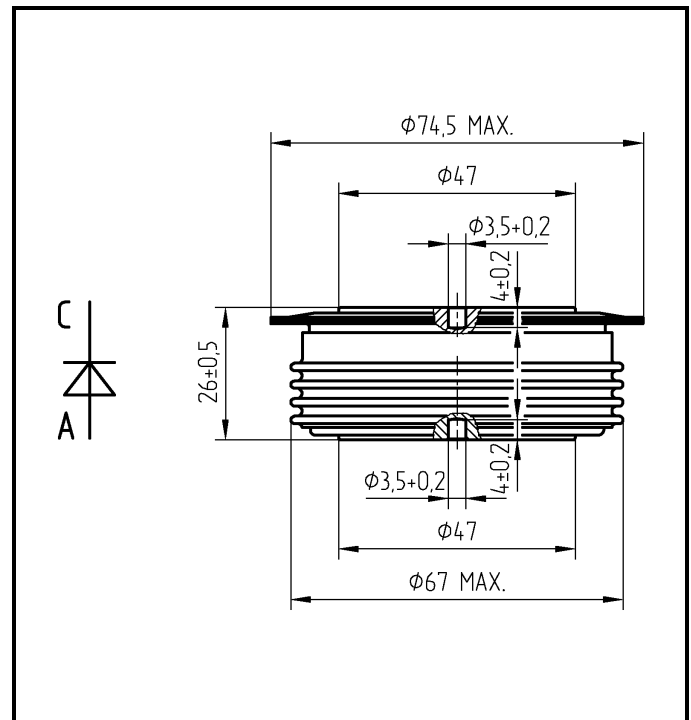

Fig. 1 Case



ABB s.r.o.

Novodvorska 1768/138a, 142 21 Praha 4, Czech Republic

tel.: +420 261 306 250, <http://www.abb.com/semiconductors>

Maximum Ratings		Maximum Limits	Unit	
V_{RRM}	Repetitive peak reverse voltage $T_j = -40 \div 160 \text{ }^\circ\text{C}$	3 800	V	
I_{FAVm}	Average forward current $T_c = 85 \text{ }^\circ\text{C}$	1 620	A	
I_{FRMS}	RMS forward current $T_c = 85 \text{ }^\circ\text{C}$	2 540	A	
I_{RRM}	Repetitive reverse current $V_R = V_{RRM}$	50	mA	
I_{FSM}	Non repetitive peak surge current $V_R = 0 \text{ V, half sine pulse}$	$t_p = 8.3 \text{ ms}$	21 900	A
		$t_p = 10 \text{ ms}$	20 500	A
I^2t	Limiting load integral $V_R = 0 \text{ V, half sine pulse}$	$t_p = 8.3 \text{ ms}$	1 990 000	A²s
		$t_p = 10 \text{ ms}$	2 101 000	A²s
P_{RSM}	Maximum avalanche power dissipation <i>rectangular pulse 20 μs</i>	50	kW	
$T_{jmin} - T_{jmax}$	Operating temperature range	-40 \div 160	$^\circ\text{C}$	
T_{STG}	Storage temperature range	-40 \div 160	$^\circ\text{C}$	

Unless otherwise specified $T_j = 160 \text{ }^\circ\text{C}$

Characteristics		Value			Unit
		<i>min</i>	<i>typ</i>	<i>max</i>	
V_{TO}	Threshold voltage			1.030	V
r_T	Forward slope resistance $I_F = 1000 \div 3000 \text{ A}$			0.320	mΩ
V_{FM}	Maximum forward voltage $I_{FM} = 4\,000 \text{ A}$			2.320	V
Q_{rr}	Recovered charge $V_R = 100 \text{ V, } I_{FM} = 2\,000 \text{ A, } di_F/dt = -5 \text{ A}/\mu\text{s}$		3 700		μC

Unless otherwise specified $T_j = 160 \text{ }^\circ\text{C}$

Thermal Parameters			Value	Unit
R_{thjc}	Thermal resistance junction to case	<i>double side cooling</i>	20	K/kW
		<i>anode side cooling</i>	34	
		<i>cathode side cooling</i>	48	
R_{thch}	Thermal resistance case to heatsink	<i>double side cooling</i>	5	K/kW
		<i>single side cooling</i>	10	

ABB s.r.o., Novodvorska 1768/138a, 142 21 Praha 4, Czech Republic

ABB s.r.o. reserves the right to change the data contained herein at any time without notice
TS - D/007/97d Nov-11

Transient Thermal Impedance

Analytical function for transient thermal impedance

$$Z_{thjc} = \sum_{i=1}^4 R_i (1 - \exp(-t / \tau_i))$$

Conditions:

$F_m = 22 \pm 2$ kN, Double side cooled

<i>i</i>	1	2	3	4
R_i (K/kW)	11.83	4.26	1.63	2.28
τ_i (s)	0.432	0.071	0.01	0.0054

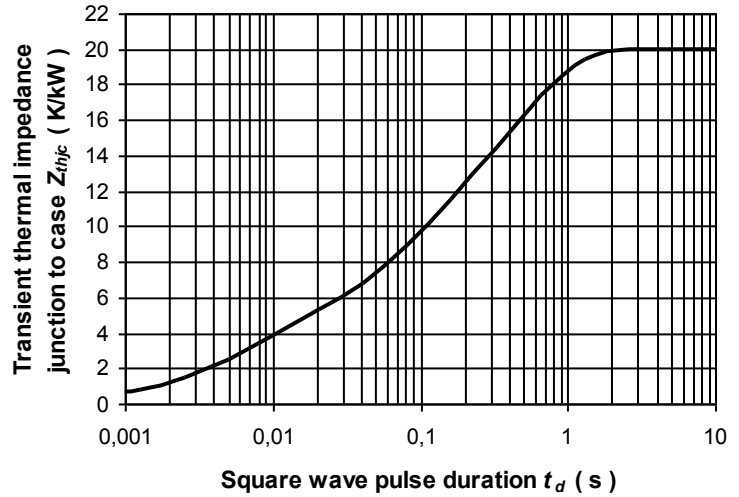

Fig. 2 Transient thermal impedance junction to case

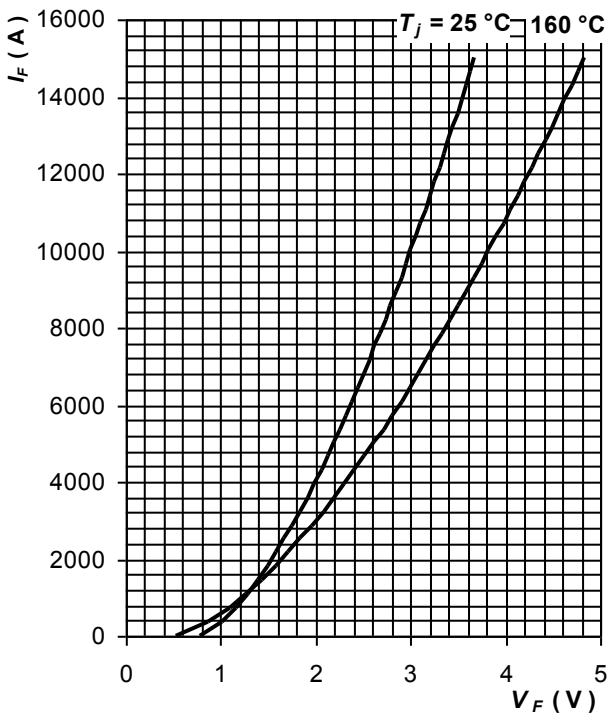

Fig. 3 Maximum forward voltage drop characteristics

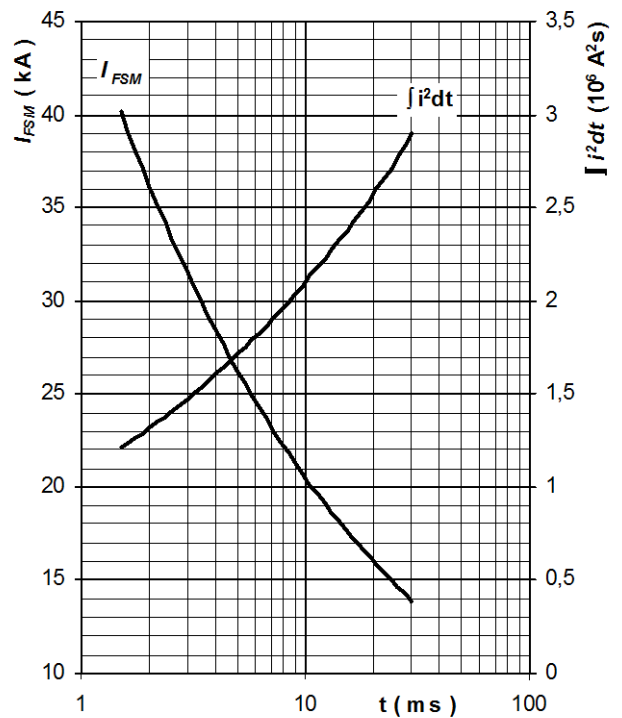

Fig. 4 Surge forward current vs. pulse length, half sine wave, single pulse, $V_R = 0$ V, $T_j = T_{jmax}$

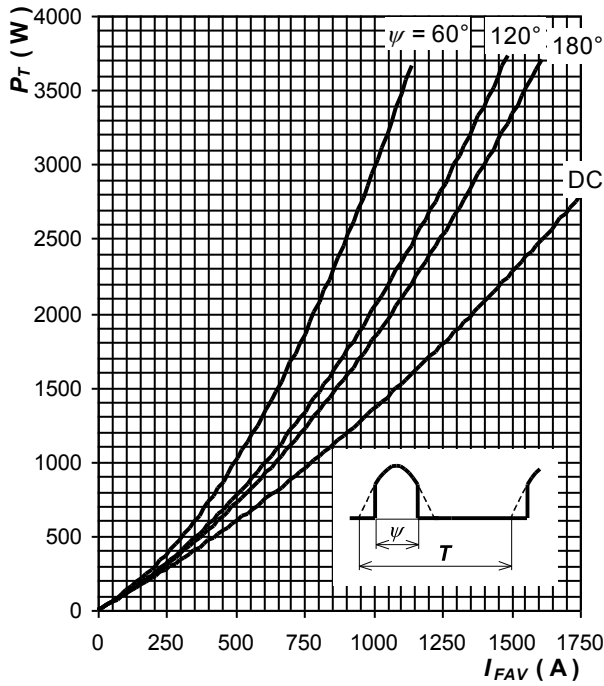

Fig. 5 Forward power loss vs. average forward current, sine waveform, $f = 50 \text{ Hz}$, $T = 1/f$

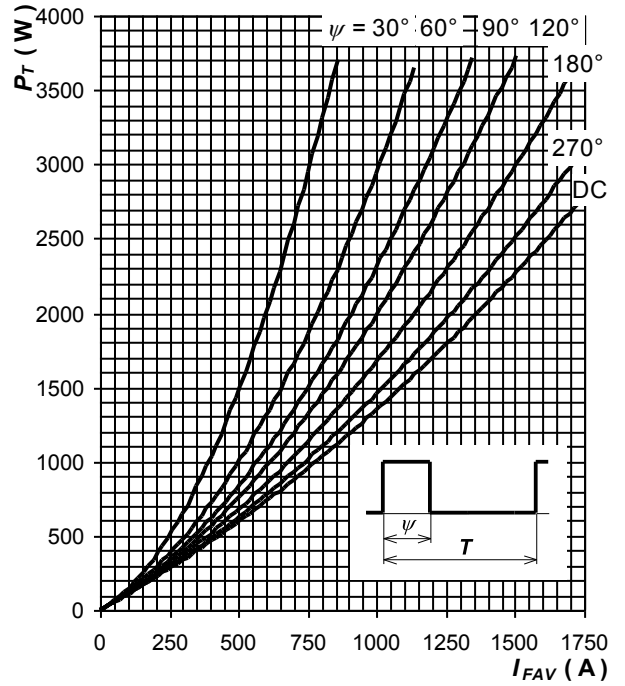

Fig. 6 Forward power loss vs. average forward current, square waveform, $f = 50 \text{ Hz}$, $T = 1/f$

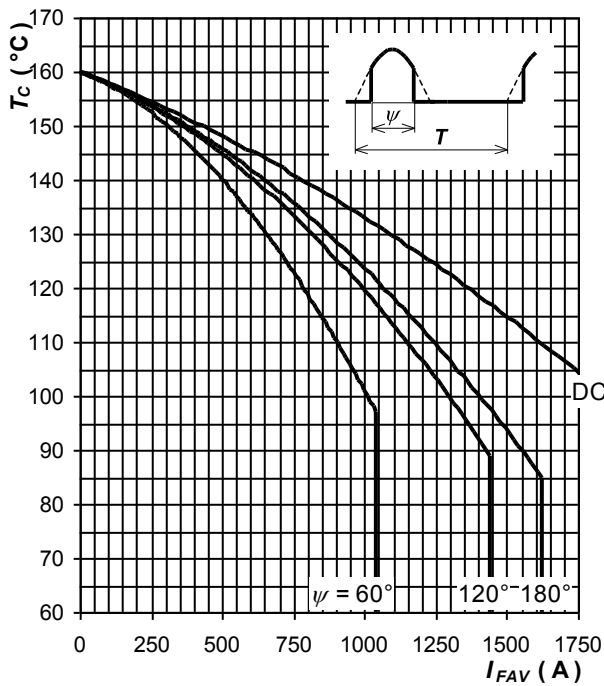

Fig. 7 Max. case temperature vs. aver. forward current, sine waveform, $f = 50 \text{ Hz}$, $T = 1/f$

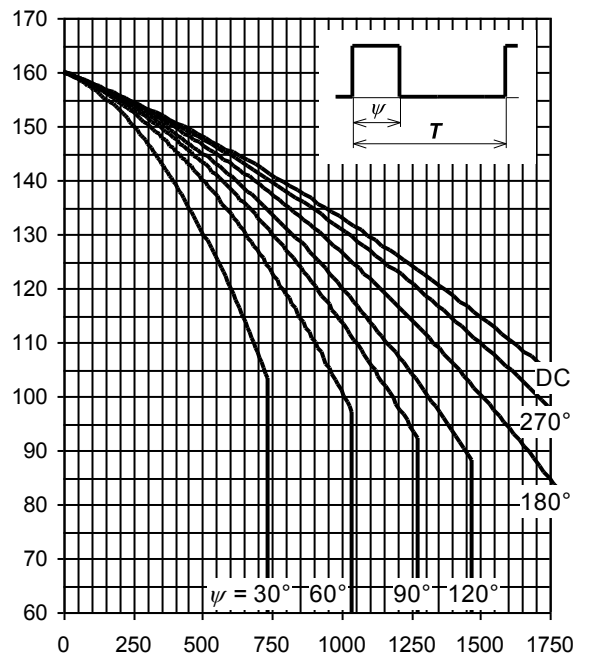

Fig. 8 Max. case temperature vs. aver. forward current, square waveform, $f = 50 \text{ Hz}$, $T = 1/f$

Notes: